

- Biology
- Chemicals
- Chemistry
- Earth, Space & Environment
- Gratnells Storage
- Lab Consumables
- Lab Equipment
- Physics
- Safety
- STEM & Data Loggers



**SERRATA**  
Cultivating the World of Science



**Flexible freight  
options available**

Prices exclude taxes & duties

**teaching.com.au**  
P +61 2 9907 5260 E [export@teaching.com.au](mailto:export@teaching.com.au)

# Contents

Biology	11
Chemicals	79
Chemistry	71
Curriculum Kits	173
Earth, Space & Environment	55
Glassware	175
Gratnells Storage	253
Lab Equipment	223
Labware	195
Meters & Testing	141
New for 2020	1
Physics	99
Plasticware	189
Safety	247
STEM & Data Loggers	147



## Serrata Science Range Now Available Through MTA



Including  
full range of  
chemicals &  
glassware

### Serrata and MTA Partnership

We are delighted to welcome Serrata, one of Australia's largest suppliers of specialised science and education equipment, into the MTA family.

Since 1969, Serrata has been established as the premier science equipment supplier across Australasia, supplying the highest quality science education resources to primary and high schools.



**FREE freight**  
on all orders over \$199

Conditions apply, see website for details.  
Valid until 31st December 2020.  
Promotional value excludes GST.  
Offer excludes export & new projects.



**Skin Burn and Normal Skin Model**

The model is enlarged 6 times. The burn side of the model shows indication of 1st, 2nd, 3rd degree burns. The reverse side illustrates normal skin anatomy.

EISM0310 \$129.95



**Human Liver with Gall Bladder Model**

Excellent for introducing the structure and function of the liver and gall bladder. The display includes 4 lobes of the liver, gal bladder, bile ducts and portal vein. Half life size 17.8 x 12.7cm.

EISM0298 \$59.95



**Human Heart Model**

Model with 4 parts shows the auricles, ventricles, cardiac valves, large vessels, cardiac muscles and more. Size 14 x 13 x 28cm.

EISM0077 4 parts \$69.95



**Human Skin Model - Enlarged 70 Times**

Model depicts three layers of the skin, hair follicles, sebaceous and sweat glands, receptors, nerves and vessels. Mounted on 33 x 23 x 5cm.

EISM0088 \$69.95



**Neuron Model**

Enlarged 2500 times, the model shows electron microscopic structure with separate modulated nerve fibre. Size 42 x 30 x 13cm.

EISM101B \$79.95



**Prehistoric Man Skull Model**

Set consists of prehistoric skulls such as Afarensis cranium, Africanus cranium, Habilis cranium, Erectus cranium, Neanderthalensis cranium and Steinheim.

EISM0127PMS Set of 6 \$499.95



**Embryonic Fetal Development**

Set of nine individual models show the stages of human development. The set includes display of embryo, uterus, fetus, placenta and umbilical cord.

EISM0122 Set of 9 \$299.95



**Animal Cell Model**

Enlarged 20,000 times, the model shows animal cell in great detail. Display includes nucleus, endoplasmic reticulum, mitochondria, ribosomes, golgi apparatus and more.

EISM0002 \$179.95



**Animal Cell Model on Base**

This is a dimensional model with one side dissected to show complete internal structure. The model is mounted on a base. Size 33 x 25 x 7cm.

EISM0004A \$79.95

New for 2020



**Mosquito Life Cycle Model**

A set of models showing the life history of mosquito (culex) with different stages from its initial stage to its complete development. Size 60 x 45 x 8cm.

EISM0148 \$279.95

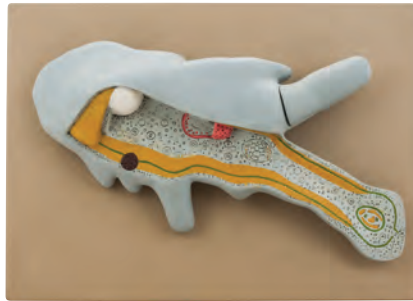

**Amoeba Model**

The model can be separated into two parts to show the amoeba proteus struture which is enlarged approximately 1000 times.

EISM0014 \$119.95



**Starfish Model**

This large star fish model is perfect for any classroom. The model depicts internal structures including digestive and reproductive organs. Size 45 x 40cm.

EISM0136 \$139.95



**Frog Dissection Model**

This detailed 3D rendering of a frog dissection is ideal for studying the structure and function of the basic organs in a frog. Size 58 X 40cm.

EISM0022AST \$199.95



**Fish Dissection Model - Perch**

This model is ideal for studying the structure and functions in a perch fish. Anatomical parts such as skull, nostrils, fin, tongue, heart, kidney, stomach and more are colored and numbered with the key that is included. Size 49cm long.

EISM0018A \$109.95



**Rat Dissection Model - Female**

Useful for students studying the structure of female rat anatomy showing all internal parts. Mounted on base. Size 61 x 30 x 5cm.

EISM0032 \$109.95

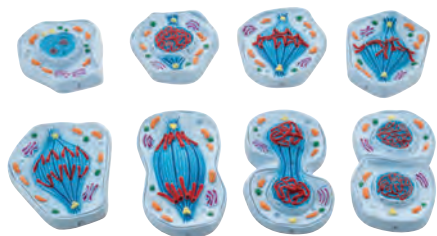

**Mitosis Models**

The brightly coloured models display each stage of mitosis in great detail. Chromosomes and centromeres are easily identifiable and explain each step of cell division.

EISM0008 Set of 8 \$129.95

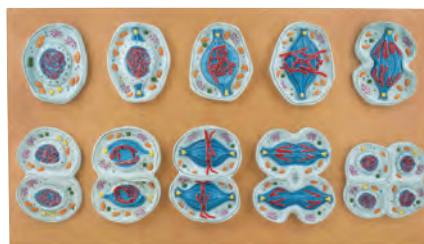

**Meiosis Models**

Robust models illustrating the process of meiosis cell division. The chromosomes are painted to allow easy identification. Size 71 x 40 x 4cm.

EISM16082 Set of 10 \$179.95



**Plant and Animal Cell Comparison Models**

Use the animal and plant cell models to show similarities and differences and point out structures and organelle of each on one side. Size 15 x 12cm.

EISM0050 \$129.95



**Plant Cell Model**

This model shows the plant cell features such as ectoplast, endoplast, tonoplast, vacuoles, nuclear structure, plastids, mitochondria and more.

EISM0008A \$69.95



**Plant Cell Model  
- Enlarged 10,000 times**

This model shows the features of a simple plant cell which is magnified approximately 10,000 times. Organelles are raised and some are bisected to show internal structures. Size 29 x 20cm.

EISM0009 \$99.95

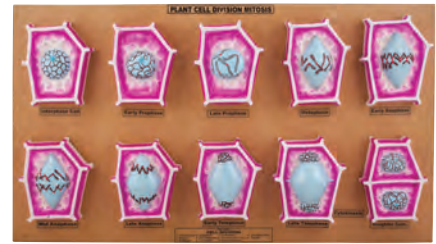

**Plant Mitosis Model**

The models shows all the stages of plant mitosis including a detailed look at interphase, prophase, metaphase, anaphase, and telophase, as well as the resulting daughter cells.

EISM0036 \$199.95



**Germination Model**

This germination model is enlarged to show beans. The model is mounted on a base and numbered with key card. Size 42 x 30 x 7cm.

EISM0047 \$149.95

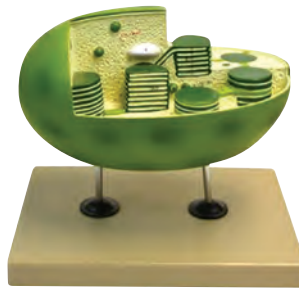

**Plant Chloroplast Model**

This model is ideal for studying the structure and function of this key plant cell organelle. Key features such as ribosomes, DNA, starch granule and more are colored and numbered for comparison with the key that is included. Size 25 x 15cm.

EISM62AS \$109.95

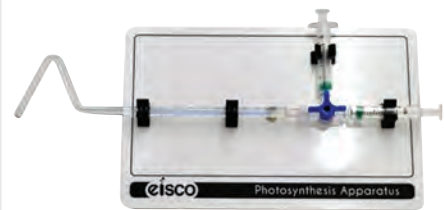

**Photosynthesis Apparatus**

For the measurement and collection of gas evolved by aquatic plants during photosynthesis. The gas evolved can be measured by the calibrated capillary tube and drawn off for analysis by the plastic syringes. Size 19 x 22cm.

EISIO228 \$24.95



**Globe Model Earth - Cross Sectional**

This model with 7 detachable parts shows the interiors of earth. When layers one by one are removed you can find the periphery of each layer.

EISBD007 7 pieces \$329.95

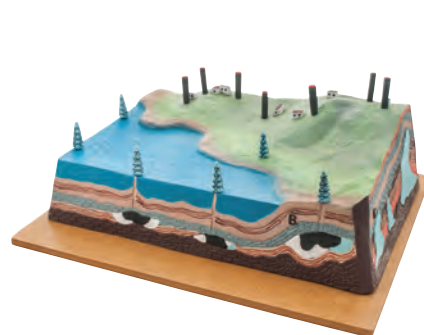

**Underground Deposits Model**

This model shows some mineral deposits and particularly oil fields, saltmines and a coal seam.

EISBD008 \$199.95



**Tulgren Funnel**

This Tulgren Funnel is supplied with coarse and fine mesh, glass collecting beaker and 3 core cable. Supplied without retort stand.

EISBI0502 \$99.95

## New for 2020

### Bio Viewer

This Bio Viewer is a light weight and easy to use micro slide viewer. It requires no power to operate and allows you to see super quality images, which the teacher can be assured that the entire class will see all of the key features quickly and easily.

EIS0276BV

\$19.95



### Bio Viewer Slide Sets

These Bio Viewer Slide Sets are a great cost effective alternative to microscope slides. Each kit has varied configurations of images from animals and humans to bacteria and viruses, plants and even fungi. The slide sets come with a protective cover for storage and to keep them dust free.

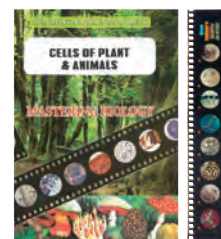
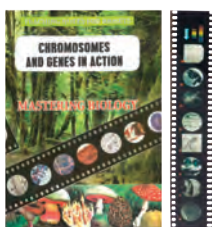

~~\$49.75~~  
**\$39.95**  
—  
Save \$9.80

~~\$19.90~~  
**\$15.95**  
—  
Save \$3.95

~~\$29.85~~  
**\$22.95**  
—  
Save \$6.90

#### Bio Viewer Slide Sets - General

EIS0276BV1	Kit	\$39.95
EISBV01	Cell of Plants & Animals	\$9.95
EISBV02	Cells of your Body	\$9.95
EISBV03	Cell Structure	\$9.95
EISBV04	Ultrastructure of Animal Cells	\$9.95
EISBV05	Meiosis	\$9.95

#### Bio Viewer Slide Sets - Animals

EIS0276BV2	Kit	\$15.95
EISBV06	The Animal Kingdom	\$9.95
EISBV07	Animal Mitosis	\$9.95

#### Bio Viewer Slide Sets - Bacteria & Virus

EIS0276BV3	Kit	\$22.95
EISBV08	Helpful Bacteria	\$9.95
EISBV09	Harmful Bacteria	\$9.95
EISBV10	The Virus	\$9.95

~~\$59.70~~  
**\$49.95**  
—  
Save \$9.75

~~\$69.65~~  
**\$56.95**  
—  
Save \$12.70

~~\$29.85~~  
**\$23.95**  
—  
Save \$5.90

#### Bio Viewer Slide Sets - Human Biology & Health

EIS0276BV4	Kit	\$49.95
EISBV11	Cells of your Body	\$9.95
EISBV12	Human Reproduction	\$9.95
EISBV13	Human Blood	\$9.95
EISBV14	Chromosomes & Genes in Action	\$9.95
EISBV15	The Circulatory System	\$9.95
EISBV16	The Endocrine System	\$9.95

#### Bio Viewer Slide Sets - Plant and Fungi

EIS0276BV5	Kit	\$56.95
EISBV17	The Kingdom Fungi	\$9.95
EISBV18	The plant kingdom	\$9.95
EISBV19	Photosynthesis	\$9.95
EISBV20	The flower of a flowering plant	\$9.95
EISBV21	Monocots & Dicots	\$9.95
EISBV22	Cell of plants	\$9.95
EISBV23	Plant Mitosis	\$9.95

#### Bio Viewer Slide Sets - Ecology

EIS0276BV6	Kit	\$23.95
EISBV24	Pond Life	\$9.95
EISBV25	Ecology under the Microscope	\$9.95
EISBV026	Evolution under the Microscope	\$9.95



EISCRBAP

EISCRBAP25

**Rubberized Cloth Apron 69 x107 cm**

This is a simple black rubberized cloth apron perfect for lab purposes. The apron measures 69 x 107cm.

EISCRBAP  
EISCRBAP25

Each \$12.95  
Pack of 25 \$279.95



**Hand Crank Centrifuge**

A very economic centrifuge that clamps right to any bench top. Apparatus has table clamp, hand crank, 4 buckets to hold tubes up to 15ml in capacity.

EIS266B

\$99.95



**Mini Vortex Mixer**

This vortex mixer offers variable speed control. Cup head and 3-inch accessory platform is included. It can be used for re-suspending liquids, mixing reagents, buffers, emulsions, ELISA assay and more.

OHAUVXMNAL

\$399.95



**pH Meter with Temp and pH Probe**

This is a reliable benchtop pH meter with product features such as built-in electrode arm and auto buffer to avoid errors. It offers a 2 point calibration with measurement resolution of 0.01pH.

OHAU2100F

\$649.95



**Mini Centrifuge**

This is a small but powerful mini centrifuge for simple and quick liquid separation. With an 8 place 1.5/2mL tube rotor, this centrifuge provides easy and safe operation for your everyday quick spin-down applications.

OHAUFC5306

\$369.95



**Starter Pen Meter 0 – 1999 us/cm**

This is a compact pen meter that provides fast and convenient measurement. Measurement range is 0-1999 us/cm.

OHAU20CB

\$179.95



**Starter Pen Meter 0.00 – 19.99 us/cm**

This is an economical pen meter that offers simple and fast operation. Measurement range is 0-19.99 ms/cm.

OHAU20CC

\$179.95



**Starter Pen Meter 0.0 – 1000 Mg/L**

This is a compact pen meter designed for fast, convenient electrochemistry measurement at your fingertips. Measurement range is 0-1000 mg/L.

OHAU20TB

\$179.95

## New for 2020

**Analytical Balance - 120 x 0.0001g**

Designed for routine weighing applications, this balance offers accuracy and repeatability in essential weighing applications. The balance has a capacity of 120g with readability of 0.0001g. Internal calibration is included for PR124.

OHAUPR124 IC - 120 x 0.0001g \$1,699.95  
OHAUPR124E 120 x 0.0001g \$1,599.95

**Analytical Balance - 220 x 0.0001g**

This balance delivers competitive performance at an economical price. The balance has a capacity of 220g with readability of 0.0001g. Internal calibration is included for PR224.

OHAUPR224 IC - 220 x 0.0001g \$1,699.95  
OHAUPR224E 220 x 0.0001g \$1,599.95

**Analytical Balance - 420 x 0.001g**

The Pioneer 423/E offers uncomplicated performance for all basic weighing needs. The balance has a capacity of 420g with readability of 0.001g.

OHAUPR423E \$999.95

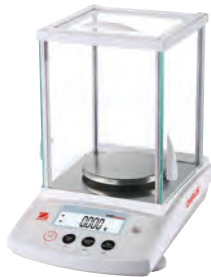
**Analytical Balance - 520 x 0.001g**

The balance has a capacity of 520g with readability of 0.001g. Featuring RS232 connectivity for easy communication, and a backlit display and a simple interface for uncomplicated operation, the balance is perfectly designed for your workplace.

OHAUPR523E \$1,199.95

**Analytical Balance - 1600 x 0.01g**

This balance offers accuracy and repeatability in essential weighing applications in laboratory, industrial and education settings. The balance has a capacity of 1600g with readability of 0.01g.

OHAUPR1602E \$949.95

**Analytical Balance - 2200 x 0.01g**

This balance has a capacity of 2200g with readability of 0.01g. It is designed for routine weighing applications in your workplace.

OHAUPR2202E \$949.95

**Analytical Balance - 4200 x 0.01g**

This balance has a capacity of 4200g with readability of 0.01g. It offers accuracy and repeatability in essential weighing applications in laboratory, industrial and education settings.

OHAUPR4202E \$999.95

**Analytical Balance - 4200 x 0.1g**

This balance has a capacity of 4200g with readability of 0.1g. Features include RS232 connectivity for easy communication, and a backlit display and a simple interface for uncomplicated operation.

OHAUPR4201E \$849.95

**Analytical Balance - 6200 x 0.1g**

This balance has a capacity of 6200g with readability of 0.1g. It delivers competitive performance at an economical price.

OHAUPR6201E \$899.95





**Oil Free Vacuum Pump**

Low voltage DC operated system supplied with an adaptor working range from 100V to 240V suitable for any type of power supply around the world.

LION1052060 \$199.95



**Large Inertia Demo**

Demonstrate inertia in a simple experiment. Pulling and releasing the trigger causes the square sheet to slide out from under the ball, dropping the ball in the receptacle by inertia.

EISLID17 \$99.95



**Newton Fan**

Use the fan to aid in demonstrating Newton's Laws. The fan can be used in cart experiments or other experiments where the use of a constant external force is needed.

EISNTNFN \$59.95



**Speaker Box on Stand**

Adjustable height allows this speaker box to work at a suitable position. It's working range is from 60 to 16000Hz. Size 10 x 10 x 23cm.

LION1088010 \$24.95



**Bottle Rocket Launching Platform**

Introduce students in the most fun way to rocket science and concepts involving Newton's laws. Launch water powered rockets over 100 ft in the air.

EIS1120143 \$119.95



**Crooke's Radiometer on Plastic Base**

This Crooke's Radiometer allows you to detect or measure radiant energy. Comes with a evacuated glass bulb which contains a rotor that spins once radiant energy is detected. Size 17.8 x 7cm.

EIS0418A \$19.95



**Simple Electric Motor Kit**

This is a simple motor kit designed to explain how electricity and magnetism behave.

LION1088012 Pack of 10 \$9.95



**Build a Motor Kit**

Use the components of this kit to build a simple motor that can run for hours. The kit includes copper coil, AAA battery and a magnet.

LION1088015 Pack of 10 \$6.95



**DC Motor Kits**

This kit contains all you need to build a working DC motor and learn its elements from the inside out. Kit includes 2 copper wire coils, plastic base, field poles, armature core, brushes and fasteners.

LION1088014 Pack of 10 \$5.95

## New for 2020

**Meld's Apparatus**

This is designed to show the effect of vibration in a stretched cord. Investigate the relationship among frequency, tension, and density mounted in a clamp.

LION1088013

\$49.95

**Economy Air Table**

With its air source built in, the table provides a frictionless, two dimensional surface for the study of velocity, acceleration, Newton's Laws, centre of mass, moment of inertia and more.

LION1088024

\$449.95

**Air Source - Dual Output**

This is a variable speed air source designed with noise-reduction technology. It is powerful enough to float fully-loaded gliders or pucks.

LION1088022

\$249.95

**Motor Generator**

This is a great product for basic training in electricity. It includes 2-pole armature, field coil pair, permanent magnet pair, 4 brushes, commutator and slip rings. Size 9.5 X 9 X 11cm.

LION1088026

\$24.95

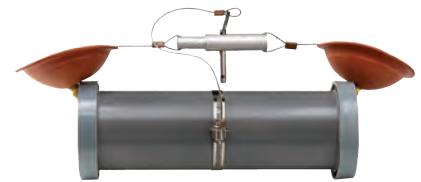
**Water Sampler**

This unbreakable plastic water sampler is ideal for schools. It has an impact-resistant grey PVC body with soft rubber seals which hold 1.75 litres.

LION1088029

\$36.95

**AC DC Motor Generator Demo**

This apparatus allows students to easily compare and contrast an AC generator and a DC generator.

EIS1245N8

\$89.95

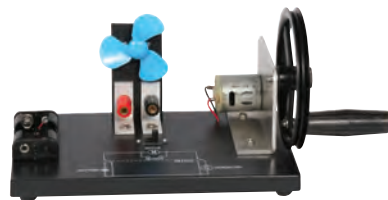
**Dynamo with Electric Motor Unit**

This motor unit shows the principle of transfer of mechanical energy to electrical power. Size 27 x 12 x 12.5cm.

LION1088011

\$24.95

**Hooke's Law Apparatus without Weights**

This complete apparatus has a 15cm adjustable scale. The adjustable scale helps to prevent parallax error.

EIS0323A

\$39.95



**G Free Fall with Electronic Stop Clock**

This electronic stop clock has a 4 digit LED display and it provides the option to record time in milliseconds or seconds to 0.001s. Size 25 x 22.5 x 12.9cm.

LION1057317 \$299.95



**Desktop Pulley - Ball Bearing Adjustable**

This apparatus is great for experiments that require pulley at different heights. The pulley rotates 360 degrees and can be adjusted. It includes glass-filled nylon molded clamp and pulley. Size 19 x 11 x 4cm.

LION1035136 \$12.95



**Solar Cell Demo Kit**

This is a simple way to teach student how solar energy can be transferred to electrical power to drive motor, generate sound, light and the LED. Size 20 x 12.5 x 6cm.

LION2874100 \$24.95



**Solar Cell Array with Mutiple Voltage Output**

The solar cell array consists of four single units (1.5V) each; which can be used individually or combined into series 1.5, 3.0, 4.5, 6 V DC. Size 20 x 18 x 25cm.

LION2874101 \$39.95



**Solar Heating Unit**

This apparatus allows you to heat water with solar energy. It consists of a large black painted plate (55 x 35 cm) and its many loops ensures that water heats up quickly. Size 61 x 64 x 34cm.

LION2874400 \$229.95



**Volta's Hailstorm**

The tiny balls inside the transparent cage bounce wildly near a Van De Graaf generator due to the electrostatic charge. The apparatus can also display Coulomb's Law. Size 9.5 x 9.5 x 30cm.

LION1035333 \$24.95

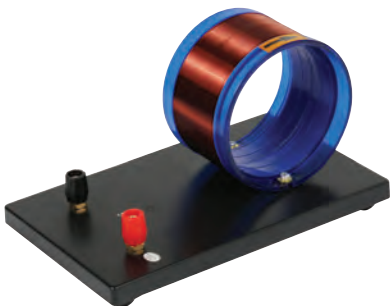

**Air Core Solenoid - 500 T**

The air core solenoid with multi selectable turns, shows students that the magnet field tension changes when the turn of the coils differ. Size 20 x 12.5 11cm.

LION1050260 \$22.95



**Shaker Sieve**

This is great for soil and general particle sifting. Size 61 x 42 x 12.5cm.

LION1088025 \$59.95



**Digital Newton Meter**

The value of force can be measured more easily than conventional spring scales with the digital newton meter. Since it supports both push and pull, it can be used for various experiments.

TECH336101 \$59.95

## New for 2020

**Digital Ammeter LCD  $\pm 0-20A \times 10mA$** 

Measures from 0.00 (1 milliamp) to 1.999 amps. It is powered by a standard 9V battery, Power turns off automatically after 20 minutes to protect against forgetful users.

IEC2122001

\$79.95

**Digital Ammeter LCD  $\pm 0-2A \times 1mA$** 

Measures from 0.00 (10 milliamp) to 19.99 amps. It is powered by a standard 9V battery, Power turns off automatically after 20 minutes.

IEC2122010

\$79.95

**Digital Voltmeter LCD  $\pm 0-20V \times 10mV$** 

Measures from 0.00 to 19.99 volts DC. Power turns off automatically after 20 minutes. It is powered by a standard 9V battery.

IEC2123001

\$79.95

**Digital Voltmeter LCD  $\pm 0-20V \times 10mV$** 

Measures from 0.000 to 1.999 volts DC. Power turns off automatically after 20 minutes and one touch of the only button restores the display.

IEC2123010

\$79.95

**Resistance Set - 7 in 1 Housing**

This high power resistor set is a unique and useful set of 7 resistors that is designed to work hard. The housing is ventilated at both ends to dissipate heat. The accuracy of these resistors is within 5% of the marked value.

IEC2710001

\$99.95

**Power Supply 0-25V AC DC 6-10A with Digital Voltmeter**

This is a robust and compact unit suitable for most laboratory experiments where large current and smooth adjustment from 0 to 25 volts of both AC and DC is required.

IEC2641002

\$699.95

**Electricity Kit in Aluminium Case - Signal and Motor Generator Included**

Designed to last for many years, this is an excellent kit to teach students all about electrical theory. It is contained in a strong aluminium carry case and the whole system is of high quality.

IEC1763010

\$1,499.95

**Cloud Chamber Cold Plate**

This safe and affordable Cloud Chamber uses a specially designed cold plate that is capable of retaining a low temperature. Ethanol and hot water are used to observe tracks of ionizing radiation.

TECH003501

\$339.95

**Radioactive Source Simulator Electronic**

This instrument simulates a geiger counter but without using actual radioactive sources. The concept of half-life is easily demonstrated and the random nature of the particle counts can be shown.

IEC2668001

\$229.95



\$199.80  
**\$179<sup>95</sup>**  
 Save \$19.85



**Anatomy Human Torso – 50cm**

This model shows students exactly where all organs go. Students will develop an understanding of anatomy in a fun way with these 11 detachable plastic organs. A great resource for Science curriculum activities. Includes full colour instructions. Size: 50cm high.

FD05001

11 pieces \$136.95

**Human Anatomy**

Children will have a better understanding of anatomy as they examine this model. The model comes with 6 detachable parts, a torso and a base. Supplied with a fully illustrated colour instruction manual. Size: 27cm high.

FD0278-4K

Set of 4 \$179.95

**Life-Size Unisex Torso**

This outstanding torso features an exposed spine with removable vertebra and spinal cord segments, a female breast plate and interchangeable male and female genitalia. The female organs include a foetus in the womb. Dissected into 23 parts: torso, female breast plate, head, eyeball, brain, vertebra spinal nerves, lung (2 parts), heart (2 parts), liver, kidney, stomach (2 parts), intestines (4 parts), male genitalia (2 parts), female genitalia with foetus (3 parts). Made of PVC plastic. Mounted on a plastic base. Size: 85cm high.

NK0306

23 parts \$399.95



**Life-Size Unisex Torso**

This outstanding human torso is a must have in every classroom! Enhance your anatomy lessons and engage your students with this excellent torso model. The model comes with 27 removable parts, so students can study the human body and its organs and location of these organs in great detail. Size: 87 x 33 x 26 cm.

SER1313024

27 parts \$649.95



**Male Musculature Model**

The model comes with 27 removable parts, so students can study the human body and its organs and location of these organs in great detail. Height: 85cm

SER1313060

27 parts \$799.95



**Genderless Open-Back Torso**

This model is an excellent resource to simulate an adult human body. This model demonstrates digestive, respiratory, and urinary systems. Open head (removable) & back of the model shows central nervous system. Size 87 x 33 x 26cm.

SER1313051

17 parts \$499.95

# Human Anatomy

## Miniature Superficial Musculature Model

This mini model accurately depicts the topography of the human superficial musculature. Great for classroom display. This model is a great visual tool for students to learn about the body's muscular system. Size: 40cm

SER1066079 40cm \$119.95



## Genderless Torso – 50cm

This model which comes with twelve removeable parts, is perfect for student to learn about basic anatomy. The parts include left & right head, brain, left & right lung, heart, liver, stomach, intestine with pancreas. Size: 52x18x18cm

SER1313005 12 parts \$129.95



## Double-Sided Magnetic Human Body



Twice the learning, skeletal system on one side and major organs and muscle groups on the other! Realistically detailed pieces combine to create a body over 90cm high.

LER6044 17 pieces \$47.95

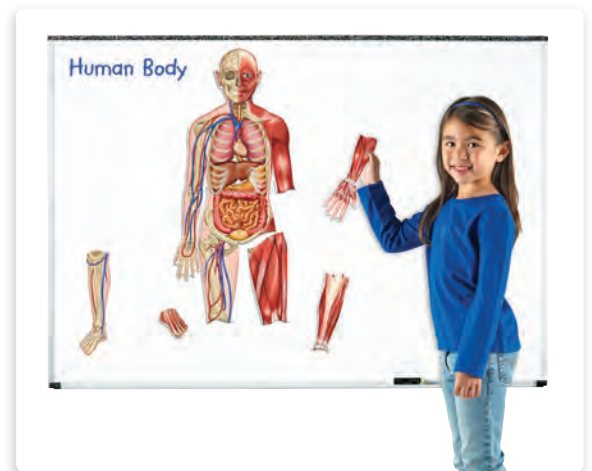

## Half-Size Circulatory System Model

This model displays all the main arteries & veins with heart & lungs. This model is half the natural size and is a great visual tool. Size: 90 x 30 x 8cm.

SER1066023 18 parts \$269.95

## Human Eye Model – 6x Enlarged

This human eye model which can be dissected into 6 parts shows blood supply, origins of the muscles, various membranes, lens and vitreous humour. Size: 12 x 12 x 19cm

NK0401 \$65.95



## Detailed Human Eye Model – 6x Enlarged

This highly detailed eye can be dissected into 6 parts to show internal structures of the eye. The cornea, iris, lens and vitreous body can each be removed. Model: 6x life size

SER1313028 6 parts \$80.95



**Skull with Brain Model**

This is a natural sized skull model with 8 part brain model inside.

SER1313084 8 parts \$149.95



**Dissectable Didactic Skull Model**

This skull model with 22 parts is visually an effective way to study the struture of the skull. Natural Size.

SER1313079 22 parts \$169.95



**Brain with Arteries Model - 8 Parts**

This model shows the brain arteries as well as the removable basilar artery, temporal with occipital lobes, half of brain stem, half of cerebellum, on removable base. Size: 18 x 14 x 14cm

EIS0019 8 parts \$184.95

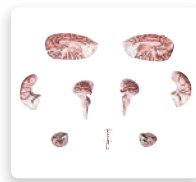

**Brain with Arteries Model - 9 Parts**

Teaching students about the functions of the human brain is easy. This model demonstrates left and right cerebrum, cerebellum & stem & basilar artery.

SER1313002 9 parts \$149.95



**Life-Size Head with Brain Model**

This head with brain model is perfect for a deeper understanding of how the parts of the brain work together. The model which is of a natural size comes with 4 parts that are removable.

SER1313049 4 parts \$180.95



**Thalamus Model - 5x Enlarged**

This model can be dissected in 5 parts; various functional areas are delineated with separate colours, thus providing a clear distinction between the different nuclei of each structure. 5x Life Size.

SER1066072 5 parts \$149.95



**Life-Size Regional Brain Model**

Life-size brain with distinct colour coding which shows the various lobes, cortex cerebellum and brain stem.

SER1066110 2 parts \$119.95

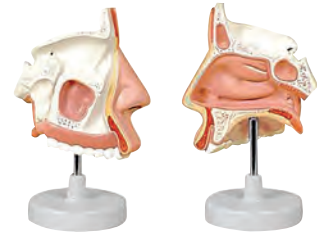

**Life-Size Nasal Cavity Model**

This life size model shows a section of the nasal cavity.

SER1066033 \$99.95

**Cross Section Models**

This kit includes one of each of the cross-section models: human brain (LER1903), tooth (LER1904), eye (LER1907) and heart (LER1902).

LER1903K Set of 4 \$132.95



**Soft Foam Cross-Section Human Brain Model**

Features frontal, occipital and temporal lobe, cerebrum, medulla oblongata, thalamus, cerebellum, hypothalamus and more. Size: 12.5cm.

LER1903 \$29.95



**Cross Section of Tooth Model**

Features enamel, dentin, pulp, cementum, nerves, blood vessels, root and crown. Size: 12.5cm.

LER1904 \$29.95

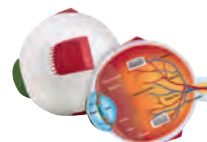

**Cross Section of Eye Model**

Features cornea, iris, pupil, retina, lens, optic nerve, vitreous humor, sclera, choroid, macula, ciliary muscle, optic disc and zonules. Size: 12.5cm.

LER1907 \$39.95



**Cross Section of Human Heart**

Features aorta, pulmonary artery, left & right atrium, inferior & superior vena cava tricuspid valve, pulmonary valve, aortic valve, mitral valve and left ventricle. Size: 12.5cm.

LER1902 \$39.95

~~\$139.80~~  
**\$132.95**  
Save \$6.85

## Human Anatomy



### Human Ear Model

View the fascinating internal parts of the ear. Three times enlarged. Ossicles and labyrinth can be removed. 30 x 16 x 9cm.

NK50542

\$37.95



### Earl Model - 3x Enlarged

This ear model is 3 times enlarged with three parts (external & middle ear). It is made of high quality PVC with the hammer, anvil, stirrup, labyrinth which are removable.

SER1066009

3parts \$89.95

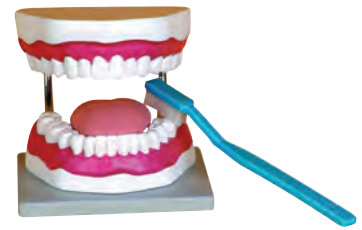

### Teeth Care with Large Tooth Brush Model

Excellent model for demonstrating dental hygiene as well as tooth care. Size: 15x16x22cm

SER1313022

\$39.95



### Giant Teeth Demo Model

This Giant Teeth model is 2x the actual size. It can be manipulated in a hand-puppet fashion and comes complete with toothbrush.

NK50544

\$49.95



### Tooth Decay Model - 3x Enlarged

This model displays tooth decay. 3 times enlarged and contains 7 parts

SER1313071

7 parts \$79.95



### Heart & Lungs Model - 7 Parts

Model shows heart, larynx, and lungs. The various parts of the model can be separated. Wind pipe, artery, vein, venacava, aorta, esophagus, and diaphragm are also shown in great detail. Size: 30 x 10 x 10cm.

EIS0068B

7 parts \$149.95

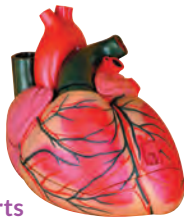

### Heart Model - 3x Enlarged - 3 Parts

This model of human heart is three times enlarged and can be separated to 3 pieces. Students can physically interact with the model and gain a more concrete understanding about this important organ.

SER1313011

3 pieces \$169.95



### Heart Model - 2x Enlarged - 4 Parts

This model which is 2 times enlarged provides an illustration of the anatomy of the human heart. The model can be separated into 4 parts.

SER1313097

4 parts \$159.95

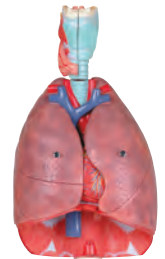

### Respiratory System Model

This model is composed of 7 parts showing the larynx, the lungs and a 2-part heart. Weight 13 kg approximately.

SER1313019

\$149.95

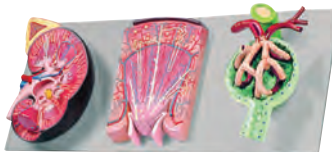

Further information can be found on [www.teaching.com.au](http://www.teaching.com.au)

### Kidney Section Model - Nephron Renal Corpuscle

View the fascinating internal parts of the kidney. Three times enlarged. The kidney shows the various glands with renal nephron and renal corpuscle. Size: 70 x 29 x 12cm.

SER1066155

\$279.95



### Lung Demonstrator Simple

Lung Demonstrator Demo kit consists of transparent plastic container, Y tube (trachea), balloons (lungs), rubber sheet (diaphragm) and instruction sheet.

SER1014918

\$41.95



### Kidney with Adrenal Gland Model - 3x Enlarged

The model displays the various kidney parts in detail. Further information can be found on [www.teaching.com.au](http://www.teaching.com.au)

SER1313012

\$99.95



**Digestive System Model**

Teach your students all about the digestive path of food. Excellent tool to show the various parts which includes esophagus, liver, pancreas, spleen and gall bladder.



SER1313003

\$189.95

**Kidney with Adrenal Gland Model - 2 Parts**

A life-size model of the kidney with the adrenal gland. It can be divided into two parts to show internal structures. Mounted on base with stand.



SER1313044

2 parts \$49.95

**Life-Size Urinary System Model**

This model shows the various parts of the urinary system in detail; including the cortex, medulla, pelvis, urethra and ejaculatory ducts. Size: 24x18x36cm.

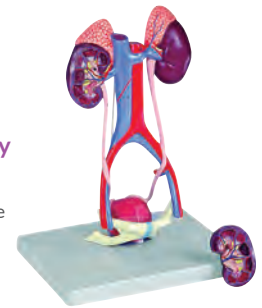

SER1066042

5 parts \$79.95



**Female Pelvi Skeleton Model**

This is a great tool to compare male and female anatomy.

SER1066082

\$39.95



**Spermatogenesis Model**

This model shows the process by which haploid spermatozoa develop from germ cells in the seminiferous tubules of the testis.

SER1313018

\$139.95



**Life-Size Male Reproductive Organs Model**

This model displays male genital organs.

SER1313038

\$79.95



**Male Bladder with Prostate Model**

This two-part model, enlarged 3 times, shows the male urinary bladder with the prostate gland surrounding the urethra. The model can be separated to expose both internal and external structures.

SER1066123

2 parts \$139.95

**Testicle Model with Cross Section**

This three dimensional model provides an excellent cross sectional view of the testicle.

SER1066124

\$79.95



**Female Reproductive Organs Model**

This model which is 1.5 x life size, shows a dissected view of the vagina, cervix, uterus and ovary with follicles at various stages of development.

SER1066029

\$59.95

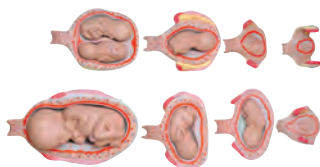
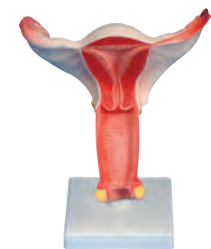

**Fetal Development Model**

This model which is a set of 8 shows the various stages of fetal development. This is an excellent visual tool that works perfectly in any classroom.

SER1313008 Set of 8 \$249.95



**Life-Size Hand Muscles Model**

This life-size model is composed of 4 parts. The underlying network of muscles, tendons, vessels and nerves are shown in great detail.

SER1066038 4 parts \$129.95



**Blood Cell Model**

This model shows the red blood cell and it's various parts including lymphocyte and monocyte. The model is 2000x enlarged and made from high quality PVC.

SER1313001 \$179.95

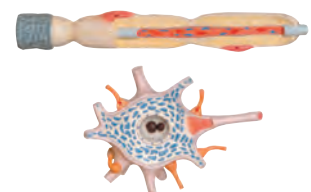

**Neuron Model - 2500x Enlarged**

This 2 part model of a neuron which is enlarged 2500 times shows electron microscopic structure and nerve fibre.

SER1313058 2 parts \$149.95

# Human Anatomy

\$1,192.40  
**\$1,104<sup>95</sup>**  
 Save \$87.45

## Human Anatomy & Skeleton Class Pack

This kit is perfect to teach students about the human body, our skeleton and bones, organs and muscles. Included is one real life size unisex human torso (NK0306), 6 student sized anatomy models (FD0278), one life size skeleton model (FD160), and one of each of the charts: organs, muscular system and skeletal system (EC0100K).

LER6044K Kit \$1,104.95



\$714.55  
**\$679<sup>95</sup>**  
 Save \$34.60

## Skeleton Class Pack



A great skeleton class pack to learn everything about the bones in our bodies. This kit consist of one life size skeleton (FD160), 6 mini skeletons (FD046), the 3D skeleton demonstration magnets (EN1760) and the skeletal system chart (EC0135).

FD160K Kit \$679.95



## Fixed Bones X-Rays Cards

Authentic x-ray images show the hardware used to fix a broken bone. Fourteen added images of the fractures on cardstock correspond to the repair x-rays. Use with a light source to view details as a doctor would!

RE9255 Set of 28 \$39.95



Buy Kit  
 Save  
**\$5<sup>95</sup>**

## Human Body X-Rays & MRI Scans Kit

The set reveals a detailed look at a variety of bones. Hold these life-sized human x-rays up to the light and see every authentic detail of a real skeleton (1.5m tall).

RE5911K Kit \$123.95  
 RE5911 Human X Rays - 18 Pieces \$64.95

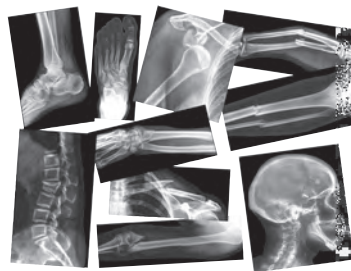

Value Pack  
 Save  
**\$13<sup>90</sup>**

## Broken Bones X-Rays

Real x-rays reveal a detailed look of common breaks to a variety of human bones. Hold up to the light or use on a light table. An informative guide is included. A total of 15 x-rays.

RE5914K X-Ray Value Pack A - A3 \$265.95  
 RE5914 X-Ray - 15 sheets \$69.95

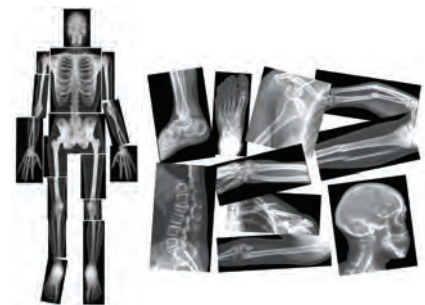

## Human Bones X-Rays Kit

Compare broken bones with healthy bones. This kit includes 1 set of True to Life Human X-Rays (RE5911) and one set of Broken Bones X-Rays (RE5914). Hold the True to Life-Size Human X-Rays (RE5911) up to the light or use them on a light table and see every authentic detail of a real skeleton. Arrange the 18 pieces together to reproduce the entire body of a young adult 1.5m tall.

RE5925K Kit \$134.90 \$128.95

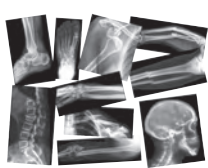

RE5914

\$109.90  
**\$104.95**  
 Save \$4.95



RE9255



**Broken & Fixed Bones Kit**

This kit includes one set of Broken Bones X-Rays (RE5914) and one set of Fixed Bones X-Rays (RE9255), to see how broken bones can be corrected again.

RE9255K Kit \$104.95



**Human Skeleton With Stand**

This close to life size model is a great resource for anatomical study. The skeleton is 160cm high.

FD160 160cm \$414.95



**Articulated Skeleton Model**

This model of the human skeleton displays all the basic features and comes with stand.

SER1052318 85cm \$99.95



**Articulated Skeleton Model - Wheeled**

This detailed model of a skeleton comes with stand and all basic features. Height: 170cm

SER1313023 170cm \$399.95



**Disarticulated Skeleton Model**

This skeleton set provides a great amount of detail for knowledge-hungry students. It can be used for demonstration purposes as well as to explore the bones and structures.

SER1066010 \$179.95



**Bones, Muscles & Ligaments Skeleton Model**

The skeleton shows bones, muscles and ligament insertions. Coloured for easy viewing of these features. Supplied with wheeled stand. Height: 160cm.

SER1313031 160cm \$479.95



**Two-Part Skull Model**

This human skull model comes in two parts, the lower jaw is removable. It's made of fibre material and comes in a natural colour. An ideal classroom resource for demonstrations! Size: 24 x 16 x 17cm approx.

EIS0126 \$64.95



**Magnetic Disarticulated Skeleton Set**

Piece together a human skeleton on your whiteboard! The textures features in this set feel like real bones. Skeleton measures almost 90cm high when assembled.

EN1760 \$109.95



**Skeleton Floor Puzzle**

Kids learn all the major bones as they assemble this unique skeleton soft foam puzzle.

LER3332 15 pieces \$64.95

# Human Anatomy

## Hanging Skeleton Model

This skeleton which shows all the basic features, is fully articulated. The top of the skull is removable allowing the examination of the internal skull structures.

SER1313108  
85cm \$399.95



## Half-Size Skeleton Model - Wheeled

Anatomically correct skeleton. Large size allows easy identification of individual bones, joints and major structures in the human body. Has 360° movement in joints and full movement in its jaw. 85cm.

NK0003 85cm \$124.95



## Human Skeleton Anatomy Model

Explore how the bones support the body, relate to the circulatory system and protect organ systems while constructing a realistic looking human skeleton model.

LER3337 85cm \$39.95

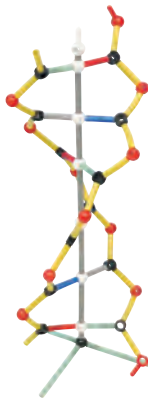

## Orbit DNA Kit - Small

This simple model of DNA shows six base pairs and can be used to model strands of RNA. Each base (guanine, cytosine, thymine, adenine and uracil) is shown by a different colour with the sugar rings, phosphate groups and hydrogen bonds in black, red and white respectively. Assembled height: 24cm.

SER1001238 \$19.95



## MolecModels3D - DNA Molecular Model 22 Layer Kit

This 22-layer model is designed for self-assembly, with the double helix structure becoming self-evident as the model is constructed. Components include colour coded bases (G,C,A And T), deoxyribose and phosphate groups, as well as a display stand.

SER1021368 \$120.95

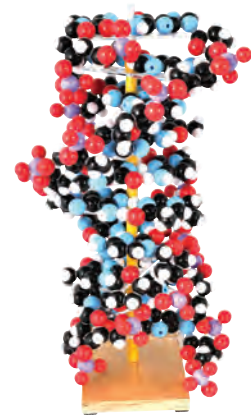

## MolecModels3D - DNA 10 Layer Kit

This model is assembled using Adenine-Thymine and Guanine-Cytosine base pairs. Arranged alternatively. It is supported on a transparent plastic platform and held to a metal rod.

SER1021021 \$249.95

## DNA Model Kit

It is easy to construct this three dimensional model of DNA. Emphasizing the base pair sequence and function of DNA, the sturdy, colourful bases snap together in the correct sequence, and the pairs attach to a center rod representing hydrogen bonds. Once completed, model can be rotated on its sturdy base. Includes enough materials to construct one models. Size 13 x 13 x 45 cm

SER1172501 \$64.95

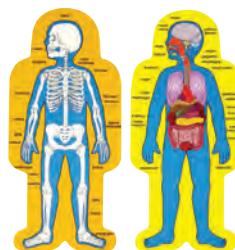

## Child-Size Human Body

This child-size human body is a helpful resource when locating, identifying and understanding relationships between organs and bones. It contains a set of two full-colour, child-size figures showing the body system and skeleton all clearly marked.

CD3215 \$44.95



## My Body in Action

Take your students on a tour of the human body! 10 beautifully illustrated animation cards depict the intricate details of body systems. Move the cards from side to side to observe the processes of various organs, from light entering the eye to blood flowing through the arteries, veins and heart valves! Includes: 10 cards (22 x 28 cm) and guide.

RE9270 Set of 10 \$29.95



### Animal X-Rays & Picture Cards

Study similarities and differences between animals. Examine real x-rays printed on clear, heavy-duty plastic, showing mammals, reptiles, fish, amphibians and birds. Includes: 14 x-rays and 14 matching picture cards, up to 10 x 25cm and teacher guide.

RE5910

Set of 28 \$39.95



### Shell X-Rays & Picture Cards

Examine real x-rays of a wide range of seashells, coral and animals to see their inner structures. The picture cards show their outside structures, colour and design. Match up the x-rays to the printed card and lay the x-ray over the card to see how the inside and outside go together. The cards measure 10 x 15cm and the x-rays vary in size. Teacher's guide and activities are included. Set of 36 cards.

RE5913

36 pieces \$46.95

## Giant Magnetic Life Cycles

These giant magnets teach students in great detail about life cycles of a frog, plant and butterfly on a whiteboard, which will interest all students in the classroom! A great resource for cross-curriculum activities. The activity guide includes detailed information about each step. The largest magnet (butterfly) is approximately 23 x 18cm. Available in set of 3 or separately. Kit contains: 1 x LER6041, 1 x LER6043 and 1 x LER6045.

LER6045K

Set of 3 \$130.95



3+ yrs

~~\$136.85~~  
**\$130.95**

Save \$5.90



### Giant Magnetic Frog Life Cycle Set

LER6041

Set of 9 \$44.95



### Giant Magnetic Butterfly Life Cycle Set

LER6043

Set of 9 \$44.95

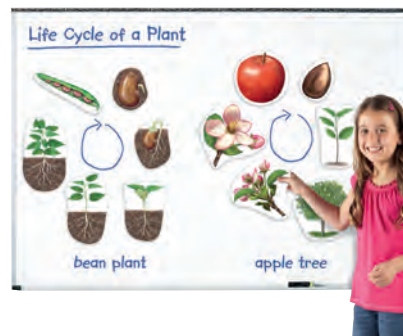

### Giant Magnetic Plant Life Cycle Set

LER6045

Set of 12 \$46.95



### Life Cycles Poster Cards A3

Encourage scientific exploration while introducing students to the various stages of growth and development in small creatures. Comprehensive and informative, this set of beautifully illustrated cards features the life cycles of a butterfly, a dragonfly and also a frog in up to four stages.

DC59060

\$44.95

### Grow Inset Four Layer Puzzles

These 30-piece wooden puzzles show the transformation from birth to adulthood in four phases. The set includes a grandfather, frog, hen and butterfly. Each puzzle is 24cm square. Ages 4+ years

ED7150

Set of 4 \$163.95

Save  
**\$15.85**



## Animals, Insects & Birds



### GeoSafari Ant Factory

It's easy for students to set up and maintain their own ant habitats! Ant Factory, measuring 23(H) x 38(W)cm, provides great lessons in responsibility, basic ecology, and much more! Each habitat includes 24-page guide book with ant care and colony observation hints, water dropper and canal starting tool. Just find some ants in the backyard (not included) and get started!

EN5145

\$74.95



### Fish Model

Teach students all about the anatomy of a fish and the function of each part with this model.

SER1066046

5 parts \$225.95



### Minibeasts Habitat Discovery Set

Get your hands (imaginarily) dirty with this wonderfully creative Minibeasts set. Comprising of 6 interactive "rooms", learn about different Minibeasts in their environment. Made up of caterpillars, beetles, spiders and worms to name a few, children can move the pieces about nature's homes, with this high quality wooden set. Measuring 45x30x17cm, it is recommended for children aged 2+ years.

FR462

15 pieces \$81.95



5+ yrs

### Chicken Life Cycle Set

Crack open this set of 21 eggs and see the day-by-day development of a chick. The first 20 eggs show a detailed realistic illustration of the chick, a plastic 3D chick is inside the final egg. The eggs and storage tray are numbered for self-checking and easy storage. The durable plastic eggs measure 7cm long. The tray is 38(L) x 21.5(H)cm. Activity guide included.

LER2733

\$64.95

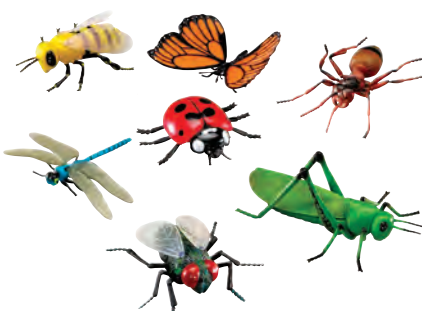

### Jumbo Insects

This jumbo insects kit is realistically detailed and comes with an activity guide which includes facts about each animal. Students love playing with these over-sized animals while learning about their characteristics. The set includes the following insects: Fly, Ant, Bee, Ladybug, Grasshopper, Butterfly and Dragonfly.

LER0789

Set of 7 \$69.95



### Life Cycle Jigsaw Puzzle Set

A set of 4 wooden jigsaw puzzles depicting life cycles of a butterfly, duck, frog and tree. Each puzzle has 9 pieces and is 20cm square. Ages 3+ years

JJ013

Set of 4 \$53.95



### Life Cycles - Butterfly & Frog & Hen

Excellent for illustrating to young children the life cycle process of three different animals. The life cycles include that of a butterfly, frog and hen. A total of 12 wooden pieces supplied in a cloth bag (20cm square). Ages 3+ years

SK82 12 piece

12 pieces \$42.95



### Insects Poster Cards A3

These insects Poster Cards will expose your students to an interesting variety of insects and their habits. Furthermore the set of illustrated cards features facts about 25 insects. Also included are diagrams showing growth and development and the anatomy of an insect.

DC59063

\$44.95

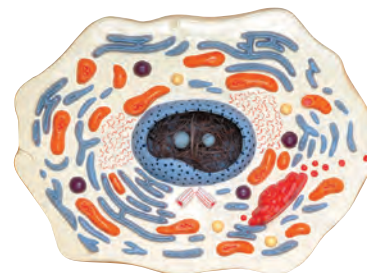

### Animal Cell Model - 20000x Enlarged

This model displays the cell of an animal. It is enlarged 20,000 times. The model shows structure & cell organelles. Made from high quality PVC. Size: 42 x 30 x 16 cm.

SER1066703

\$179.95



**Animal Habitats Game**

This Animal Habitats game allows children to compare animals in familiar habitats with animals found in less familiar habitats. The 4 double-sided A4 playing boards feature a single habitat on one side (coast, woodland, polar and desert) and a habitat bingo game on the reverse.

ZZ0046

\$54.95

**Mitosis Model**

This 8 model set shows the different stages of mitosis. Explore characteristics of structures such as chromosomes, spindle, centrioles and nucleus. Size: 18 x 18 x 3 cm.

SER1066704

Set of 8 \$199.95



**Underwater Sea Life Felt Kit**

A deep blue sea sets the scene for water-world adventures. Dolphins, whales and all sorts of exotic sea life are ready to play a role in underwater tales. The felt background measures 91 x 66cm and includes 40 underwater felt creatures. Supplied with a descriptive booklet. Ages 5+ years

LV2385

41 pieces \$56.95



**External Features of Living Things Kit**

The items in this biology kit will teach students about the external features of plants, insects and humans. Contents may vary.

ESC001B

\$433.95

**Kit includes**

- Typical Flower Model
- Mini Beasts Large Insects & Spider Set
- Body Basics Set
- Mr Face Felt Activity Set
- Jumbo Insects - Set of 7

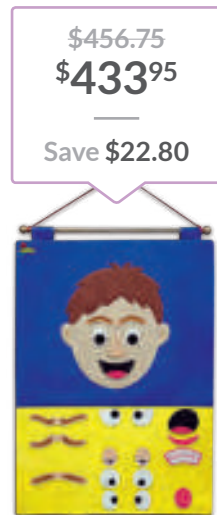
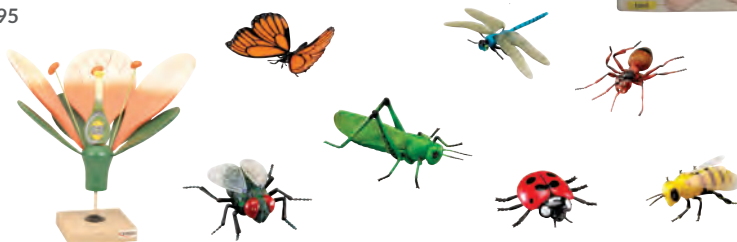

~~\$456.75~~  
**\$433<sup>95</sup>**

Save \$22.80



**Dissectible Frog Model - 3x Enlarged**

Model of a dissectible frog that is enlarged three times.

SER1066039

\$119.95



**Amoeba Model - 1000x Enlarged**

This detailed model of amoeba is 1000 times enlarged and is ideal to learn the structure and function of an amoeba. Size: 33x23x5cm.

SER1066700

\$69.95

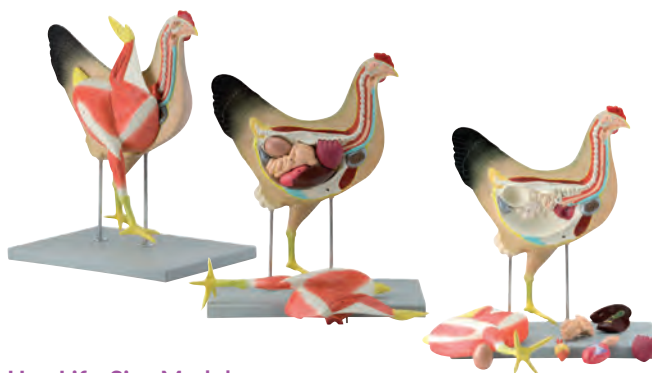

**Hen Life-Size Model**

This 8-part life-size model describes in great detail the anatomy of a hen. The right side shows the external morphology while the right part reveals the inner structures such as: muscles, heart, liver, intestine, stomach, lungs, reproductive system and an egg. The model comes with an accompanying multilingual k-card identifying 39 structures.

SER1066025

3 part \$249.95

Plants

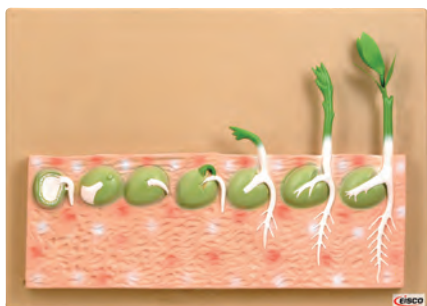

**Seed Germination Model**

This pea model shows step by step how plants emerge from seeds and begin to grow – the germination of the pea. A labelled guide is included. Size: 40(W) x 30cm(H). Ages 6+ years

EIS0046

\$81.95

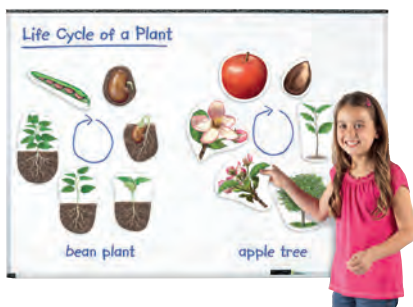

**Giant Magnetic Plant Life Cycle Set**



These giant magnets teach students about the life cycle of a plant. A great resource for cross-curriculum activities. The activity guide includes detailed information about each step. The largest magnet is approximately 23 x 18cm.

LER6045

Set of 12 \$46.95



**Aquaponics Flower Tower**

The Aquaponics flower tower is perfect for growing herbs, vegetables and flowers inside or out. Just add fish and seeds! The flower tower comes with 16 convenient planter locations. The water flow regulator ensures an even flow of water. The plants will filter the water for the fish, while the fish fertilise the water for the plants. A perfect ecosystem!

RGP0020

\$299.95



**Handy Microscope with Bug Container**

This all-in-one handheld microscope includes a collection vial with air-holes and built-in 3x magnifier. Observe nature like never before with the up-close 40x magnification and built-in LED light. Includes a built-in carabiner for easy attachment to backpacks or belt loops.

EN5300

\$19.95



**Ganong Potometer**

Demonstrates transpiration rates of water absorption by a plant shoot under various external conditions.

SER1010326

\$49.95



**Plant Cell Organelle Model – 2000x Enlarged**

Model Plant Cell organelle, 2000 x. Shows typical structure with all types of organelle. Size: 42 x 30 x 3cm.

SER1313042

\$79.95



**Dicot/Monocot Germination Model**

This model is a great visual tool to study the process of germination.

SER1313077

\$199.95



**Dicot Plant Leaf Structure Model**

This model is 700 times enlarged. Sectioned in both transverse & longitudinal direction showing the microscopic structure.

SER1066510

\$139.95

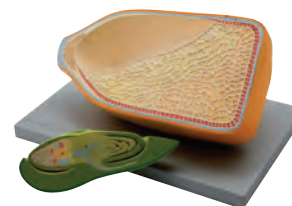

**Corn Seed Model – 40x Enlarged**

This model is 40 X life size; it shows the corn seed in longitudinal section with excellent details of the seed coat and endosperm. The seed embryo can be removed for closer examination of its internal features.

SER1066710

2 parts \$165.95





### Dissectible Typical Flower Model

This greatly enlarged model of a typically idealised flower is an ideal resource to help children understand the principles of pollination and fertilisation in plants. The dissectible flower model is made of non-breakable plastic and features detachable parts. The flower is numbered, and the model comes with a key card for identifying the specific parts of the flower. Size: 30 x 18 x 38cm.

EIS0100

\$66.95



### Hydroponics Lab

This set of three growing tubes is a mess-free way to explore hydroponics with water or any media. The transparent seed basket shows how the plant grows and you'll see: no soil required! Includes a write & wipe surface for specimen labels. Includes: 3 plastic test-tubes (4.5cm in diameter x 18cm high), 3 support rod tops and bottoms, 3 seed baskets and an activity guide.

EN5099

Set of 3 \$44.95



RGP134K  
Save  
**\$180**

### Vegetable Root Viewer with Seeds

Observe vegetables growing below the soil! Perfect for simple root vegetables like carrots. The acrylic window is on an angle, which lets the roots grow against the window for a perfect view! Available in root viewer only (RGP134) or as a kit, with seeds included (carrot and beetroot). Soil not included. It measures 40(L) x 15(W) x 24(H)cm.

RGP134

Root viewer only \$49.95

RGP134K

Root viewer &amp; seeds \$53.75 \$52.95



### Water Garden 2.0 - Aquaponic System

Learn about aquaponics and find out how plants and fish help each other to create a better living environment. Please note that the seeds included in FLD006 are not available in NZ/WA/TAS. We suggest the purchase of FLD006-NS (no seeds included) for these customers. The award-winning Water Garden has been beautifully designed with new features including:

- Elegant curved tank
- Double the growing space!
- Customised Grow Pods for easy planting and harvesting
- More seeds to continue growing for months
- Easy tank access to personalise your betta's home
- Includes free access to accompanying STEM educational curriculum for kids

FLD006

Tank with seeds \$224.95

FLD006-NS

Tank without seeds \$224.95

### Kit includes

Fish tank and gravel; Growstones™; Natural fertiliser; Fish food; Australian and organic wheatgrass and snow peas sprout seeds; Silent, submersible water pump; Assembled in Australia with local and imported parts

## Mini Beasts & Plastomounts

### Mini Beast Life Cycle Super Kit

This kit includes one of each: Mini Beast Life Cycle of the Silkworm (KNB0003), Mini Beast Life Cycle of the Honey Bee (KNB0004), Mini Beast Life Cycle of the Frog (KNB2611), Mini Beast Life Cycle of the Butterfly (KNB2711) and the Life Cycle of the Peanut (KNB2215).

KNB2215K Set of 5 \$373.95



~~\$392.75~~  
**\$373.95**  
 Save \$18.80



KNB0004



KNB0003



KNB2711



KNB2611



KNB2215



#### Life Cycle of the Honey Bee

The set includes 5 resin blocks, showing the eggs, larva and pupa, the drone, queen and worker, foundation and honeycomb, pollen, beeswax and honey and a worker bee on a flower. Teacher's guide included. Each block measures 4(L) x 2(W) x 7(H)cm.

KNB0004

Set of 5 specimens \$79.95



#### Life Cycle of the Silkworm

The set includes 5 resin blocks measuring 4(L) x 2(W) x 7(H)cm, of the eggs of silkworms, the silkworm, the cocoon, the moth and threads of silk. A teacher's guide is included.

KNB0003

Set of 5 specimens \$79.95



#### Life Cycle of the Butterfly

Shows the development of the butterfly in four stages. Largest resin block measures 7.3(L) x 1.5(W) x 7.3(H)cm. Supplied in storage and display box. Teacher's guide included.

KNB2711

Set of 4 specimens \$79.95

#### Life Cycle of the Frog

Shows the development of the frog in six stages. Each resin block measures 3.3(L) x 2.2(W) x 6(H)cm. Supplied in storage & display box. Teacher's guide included.

KNB2611

Set of 6 specimens \$72.95



#### Life Cycle of the Peanut

Studying life cycles of plants provides children with numerous learning opportunities to question and describe changes that occur as living things grow. Includes teacher's guide with links to ACARA. Set of 6 resin blocks, 4 blocks measuring 3(L) x 4.5(H)cm and 2 blocks measuring 4(L) x 7.2(H)cm.

KNB2215

Set of 6 specimens \$79.95

~~\$232.85~~  
**\$221.95**  
 Save \$10.90



KNB0004



KNB2611



#### Life Cycles Kit

Investigate the world of little creatures with this kit. It includes 1x Honey Bee Life Cycle (KNB0004), 1x Frog Life Cycle (KNB2611) and 1x Butterfly Life Cycle (KNB2711). The kit shows the development of honey bee, frog and butterfly.

KNB0004K

Set of 3 \$221.95



KNB2711



## Mini Beasts & Plastomounts



### Animals Life Cycles Slides & Viewer

View animal life cycles in a whole new light! Frog, crab, scorpion, spider and cockroach life cycles are included in this set. Set contains 5 life cycle slides 75 x 75mm, 1 light up viewer and a teacher guide.

KNB0400 Each \$99.95

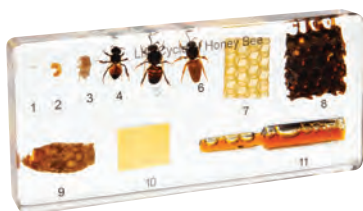

### Honey Bee - Life Cycles

This set is an excellent resource to introduce children to the different life cycles of living things. It includes 4 stages of the honey bee lifecycle, 2 worker bees and a drone, comb foundations, beeswax and honey. Measurement: 140 x 65 x 18mm.

KNB4444 \$79.95



### Large Beetles & Bugs Set

This set includes 24 different specimens of beetles and bugs. Each resin block measures 2.8(L) x 4.3(H) x 1.9(W)cm. Supplied in storage and display box. Teacher's guide included.

KNB2216 24 specimens \$199.95



### Small Insect & Spider Set

A set of 6 insect and spider specimens. Largest resin block measures 4.2(L) x 10.9cm(H). Supplied in storage and display box. Teacher's guide included.

KNB2511 6 specimens \$79.95

### Animal Kingdom Plastomount Set

This plastomount set includes vertebrate and non vertebrate species. Non Spinal animals : Leech, cuttlefish, spider, centipede, crab, long horned beetle, cricket, cockroach, wasp, lychee stink bug, cicada, mantis, butterfly, dragonfly and stick insect. Vertebrata: swordtail fish, frog, water snake, zosterops and bat

SER1080663 20 specimens \$269.95



More information on this product can be found on [www.teaching.com.au](http://www.teaching.com.au)

### Grasshopper - Life Cycle

High quality plastomount depicting a grasshopper's life cycle. Very clear and comes with identification key. Size: 167 x 78 x 20mm

SER1000013 \$39.95



### Five Hearts Comparative Plastomount

This plastomount shows different animal hearts for a comparative look. Heart types included are fish, frog, snake, pigeon and rabbit. High quality and very clear, comes with identification key. Size: 164 x 78 x 24 mm

SER1000021 \$99.95



### Mini Beasts Large Arthropod Set

This set includes 13 different arthropod specimens, including a dragonfly, golden scorpion, tarantula spider and more. The largest resin block measures 7.5cm square. Supplied in storage and display box. Teacher's guide included.

KNB005 13 specimens \$199.95



### Five Brains Comparative Plastomount

High quality plastomount with clear displays of brain types: fish, frog, snake, pigeon and rabbit. The plastomount comes with identification key. Size: 164x78x24mm

SER1000022 \$119.95

## Mini Beasts & Plastomounts

### Mini Beast Viewer Kit

See the amazing Mini Beasts like never before with the new Mini Beast Viewer! The Viewer illuminates the specimens allowing the students to see the organisms in a whole new light! Kit includes 1x LAND Mini Beast Slides & Viewer, 1x WATER Mini Beast Slides & Viewer, 1x AIR Mini Beast Slides & Viewer

KNBSK \$269.95

**Each set includes**

- 6 slides - 7.4 x 7.4 x 1cm
- 1 x LED Slide Viewer - 11 x 9.8 x 4.7cm
- Teacher's Guide

LED Slide Viewer included in each set



~~\$299.85~~  
**\$269.95**  
 Save \$29.90



#### Mini Beast LED Slide Viewer

The LED Slide Viewer adds another dimension to the Mini Beast Specimens. Lights on the sides and bottom of the viewer illuminate the specimen slides in a way children will find amazing. Offers over 800 hours of viewing time.

KNBV \$29.95

#### Land Mini Beast Slides & Viewer

This set includes 3 groups of arthropod specimens - insects, arachnids and myriapods. Using the viewer to illuminate these specimen slides provides children with an exciting way to investigate the amazing Animal Kingdom. Teacher's guide is included.

KNBS01 \$99.95

#### Air Mini Beast Slides & Viewer

These 6 insect specimens and viewer allow children to investigate the similarities and differences that exist between insects. The Mini Beasts specimens when illuminated look amazing. Teacher's guide is included.

KNBS03 \$99.95

#### Water Mini Beast Slides & Viewer

This set includes specimens representing the cnidaria, echinoderms, annelids and molluscs groups. These slides provide an opportunity to introduce children to the classification of the animal kingdom. Teacher's guide is included.

KNBS02 \$99.95



#### Large Insect & Spider Set

This set includes 15 different spider and insect specimens. Largest resin block measures 7.5cm square. Supplied in storage and display box. Teacher's guide included.

KNB2411 Set of 15 specimens \$199.95



#### Silkworm - Life Cycles

An excellent resource to introduce children to the different life cycles stages of silkworm - eggs, 2nd, 3rd and 4th instars, larva, cocoon, pupa and a male and female butterfly. Block measures 165 x 80 x 20mm. Includes teacher guide.

KNB3333 \$79.95



#### Frog - Life Cycle

This highly detailed plastomount, shows the frog life cycle from beginning to adult. The model comes with an identification key. Size: 140 x 64 x 18mm

SER1000012 \$29.95

#### Frog Plastomount

High quality and very clear plastomount of a frog. It comes with identification key. Size: 75 x 75 x 30 mm

SER1000018 \$19.95



## Mini Beasts & Plastomounts



### Butterfly Specimens

This set of 10 laminated butterflies show the beautiful wings in great detail. Identify differences and similarities between the 10 species. These laminated butterflies are a great resource in combination with a light box, or stick them to a window as decoration! Each sheet is 11cm square.

KNB007

Set of 10 \$39.95



### Mini Beasts Life Cycles - Lacewing Butterfly

Four stages of the lacewing butterfly life cycle are encased in this high-quality acrylic block - eggs, larva, pupa and a male and female butterfly. Acrylic block measures 163 x 75 x 18mm. An excellent resource to introduce children to the different life cycles of living things. Includes teacher guide.

KNB1111

\$83.95



### Mini Beast Life Cycle Slides & Viewer - Insects

The viewer illuminates these insect life cycles allowing students to see them in a whole new light! Honey bee, dragonfly, cabbage white butterfly, lanternfly and Grasshopper life cycles are included in this set. Warning: Contains coin/button battery. Hazardous if swallowed. Each set contains: 5 Insect life cycle slides 75 x 75mm, 1 Light up Viewer and a Teacher Guide.

KNB0500

\$99.95

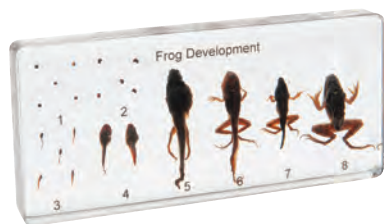

### Mini Beasts Life Cycles - Frog

Eight stages of the frog life cycle are encased in this high-quality acrylic block - eggs, tailbud, tadpoles with external and internal gills, tadpoles with hind and fore limbs, tadpole with shortened tail and froglet. Acrylic block measures 140 x 65 x 18mm. An excellent resource to introduce children to the different life cycles of living things. Includes teacher guide.

KNB2222

\$84.95



### Mini Beasts Large Ocean Set

This set includes 11 different sea life specimens, from crabs to jellyfish and octopus. The largest resin block measures 7.5cm square. Supplied in storage and display box. Teacher's guide included.

KNB006

Set of 11 specimens \$199.95



### Toad Dissection Plastomount

Toad Dissection is detailed and very clear and comes with an identification card. Ask and answer questions about the internal make up of a toad and understand all about a toad's anatomy. Size: 190 x 100 x 40mm

SER100008

\$92.95



### Rabbit Skeleton Plastomount

This plastomount of a rabbit skeleton is a great way to learn about rabbit's anatomy and function of parts. Size: 200 x 90 x 40mm

SER1000001

\$98.95



### Rat Dissection Plastomount

Rat dissection with identification key provides a very detailed and clear view. Size: 190 x 105 x 40mm

SER1000010

\$98.95

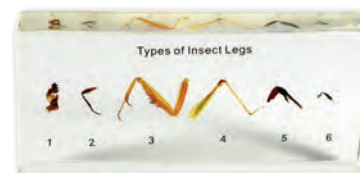

### Insect Leg Adaptations Plastomount

This plastomount shows nature's modification of insect legs running, jumping, grasping, digging and swimming. The plastomount comes with identification key. Size: 75 x 75 x 30 mm

SER1080633

\$24.95

## Mini Beasts & Plastomounts



### Spider Plastomount

This plastomount of a spider is a great education tool to learn and discover the anatomy of a spider. It can be handed around the classroom and examined up close by students without any risk of damage. Size: 41 x 73 x 25 mm

SER1080603

\$7.95



### Snake Skeleton Plastomount

This plastomount of snake skeleton is portable and encased in a transparent resin protecting the delicate form from any damage. A great way for students to learn from observing and examining the snake skeleton. Size: 135 x 90 x 24mm

SER1000006

\$79.95



### Plant Kingdom Plastomount Set

This set contains nine resin blocks with a total of 32 specimens. It is supplied in a case with a foam insert that has cut-outs for the resins block to sit. The set includes the following: Algae – four specimens; Fungi – three specimens Bryophyta – six specimens; Fern – seven specimens; Gymnosperm – two specimens; Angiosperm – ten specimens.

SER1080670

32 specimen \$229.95

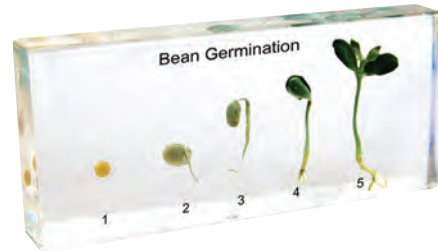

### Bean Germination Plastomount

Plastomount depicting bean germination. High quality and very clear plastomount of 6 specimens; comes with identification key. Students will be able to ask and answer questions about the various stages of bean germination; and identify the different stages of bean germination. Size: 140 x 64 x 18mm

SER1000014

\$19.95



### Fish Skeleton Plastomount

Explore the skeletal parts of a fish and understand fish anatomy with this detailed plastomount. Size: 180 x 80 x 30 mm

SER1000002

\$59.95



### Marine Animal Kingdom Plastomount Set

This 8 piece set is a great educational teaching aid to examine up close and in detail a collection of different marine species. Learn all about the different sea creatures with clear viewing from all angles.

SER1000030

Set of 8 \$129.95

## Mini Beasts &amp; Plastomounts

SER1080501	Algae Marine Plastomount – Set of 7	\$111.95
SER1080659	Amphioxus Plastomount	\$89.95
SER1080572	Annelid Types Plastomount	\$39.95
SER1000005	Bat Skeleton Plastomount	\$49.95
SER1000004	Bird Skeleton Plastomount	\$54.95
SER1080565	Brachiopod Lingula Plastomount	\$69.95
SER1194032	Butterfly & Moth Comparative Plastomount	\$89.95
SER1080624	Butterfly Plastomount	\$89.95
SER1080600	Centipede & Diplopod Plastomount	\$29.95
SER1080644	Chick Development Plastomount	\$109.95
SER1080508	Clubmosses Plastomount	\$97.95
SER1080541	Cnidaria Plastomount – 2 Types	\$99.95
SER1080589	Crustacea Plastomount	\$99.95
SER1080581	Echinoderm Plastomount – Set of 4	\$129.95
SER1000031	Evolutionary Milestone Animals Plastomount	\$199.95
SER1000007	Fish Dissection Plastomount	\$55.95
SER1080503	Fungi Plastomount – Set of 4	\$99.95
SER1080520	Germination In Dicotyledons Plastomount	\$99.95
SER1000019	Grasshopper – Whole Mount Plastomoun	\$19.95
SER1000016	Jellyfish Plastomount	\$34.95
SER1080502	Jellyfish Plastomount	\$88.95
SER1080507	Life Cycle of Fern	\$86.95
SER1080506	Life Cycle of Moss	\$86.95
SER1080621	Life Cycle of Cicada	\$89.95
SER1080611	Life Cycle of Cockroach	\$99.95
SER1080612	Life Cycle of Cricket	\$109.95
SER1080630	Life Cycle of Honeybee	\$46.95
SER1080626	Life Cycle of Housefly	\$89.95
SER1080623	Life Cycle of Lepidoptera Butterfly	\$89.95
SER1080625	Life Cycle of Mosquito	\$89.95
SER1080615	Lifecycle of Dragonfly	\$89.95
SER1080601	Millipede Plastomount	\$9.95
SER1080580	Mollusc Plastomount – Set of 6	\$129.95
SER1080519	Monocot and Dicot Comparison Plastomount	\$92.95
SER1080661	Mouse (Adult) Plastomount	\$89.95
SER1080559	Nematode Types A Plastomount	\$30.95
SER1080511	Parasitic Plants Plastomount	\$79.95
SER1080543	Phylum Platyhelminth Plastomount	\$12.95
SER1000009	Pigeon Dissection Plastomount	\$139.95
SER1080515	Plant Reproduction Vegetative Plastomount	\$119.95
SER1080602	Scorpion Plastomount	\$89.95
SER1080513	Seed Dispersal Plastomount	\$119.95
SER1000029	Sheep Heart Bisected Plastomount	\$99.95
SER1000011	Squid Dissection Plastomount	\$64.95
SER1080553	Tape Worm Dipylidium Caninum Plastomount	\$19.95
SER1080604	Life Cycle of Tick	\$89.95
SER1080658	Toad Plastomount	\$89.95
SER1000003	Toad Skeleton Plastomount	\$49.95

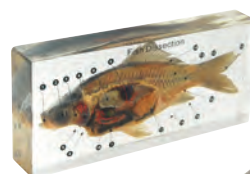

SER1000007



SER1000011



SER1080501



SER1194032



SER1080624



SER1080506



SER1080615

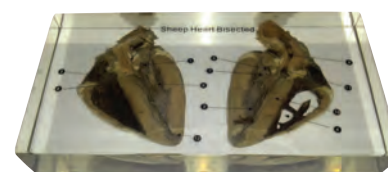

SER1000029

## Biology Tools

Set of 30  
Save  
**\$390**



### Invicta - Bug Pots

Children will find the bug pots a useful addition to their study of nature. The individual transparent pots with magnifying lids can be used to observe findings. Each pot measures 4.5 x 5.2cm.

IP0401 Set of 10 ~~\$29.95~~  
IP0401-30 Set of 30 ~~\$89.85~~ **\$85.95**



### Hand Magnifiers

View objects up close with this set of 12 magnifiers. Each magnifier measures 15.5cm long, with a diameter of 7.5cm. The magnification is 5x. Both the frame and handle are made of plastic. Perfect for little hands!

NK2804 Pack of 12 **\$43.95**

Set of 10  
Save  
**\$255**



### Bug Viewer

Children can have a closer look at all things small with this crystal clear plastic container with colourful edges and built in airholes. It has two high quality magnifying lids that focus by moving the viewer up and down. One lid has 2x magnification and the other has 3.5x magnification. It measures 7cm diameter x 8cm high.

FD005K Set of 10 ~~\$69.50~~ **\$66.95**  
FD005 Each **\$6.95**

Set of 6  
Save  
**\$575**



### Two Way Viewer

Bugs are cool and fun to view. Look at them up close with this amazing Two Way Bug Viewer. The two way viewer allows you to observe your bug from the top as well as from the bottom. Great to watch with friends as two can view at one time!

FD0201-6 Set of 6 ~~\$119.70~~ **\$113.95**  
FD0201 Each **\$19.95**

Set of 6  
Save  
**\$775**



### Giant Bug Viewer

This ventilated bug viewer can be opened on both sides for easy access. Its large size (13.5cm high) makes it a versatile viewer for both small insects and larger specimens. The giant bug viewer has a 5x magnification.

FD150BK Set of 6 ~~\$77.70~~ **\$69.95**  
FD150B Each **\$12.95**



### Critter Canister

You can examine all your little critters up close, in this 7.5cm acrylic bug viewer. Each canister features a 2X magnifying lens built into the lid. As well as 8 breathing ducts for proper ventilation and measuring grid in the bottom. Also useful for close up examination of flowers, plants, or stamps and coins.

NK50731 **\$3.95**



### Binoculars with Carrying Bag

These binoculars will get your students excited about exploring nature! Perfect for field trips to explore plants and wildlife in great detail. Go on a viewing expedition all in the name of science with this essential, multi-purpose device.

FD009 Set of 6 **\$21.95**



### Jumbo Magnifiers with Stand

Observe on a grand scale with extra-large magnifiers, sized perfectly for small hands. Flip-out stands on each magnifier allow for engaged, hands-free viewing. Each magnifier's super-safe plastic lens measures 11.5cm in diameter and offers 4.5x magnification. Set of 6 comes organised in a convenient stand. Magnifiers measure 20cm long.

LER2781 Set of 6 **\$76.95**

### Eye Magnifier

3X magnifier for looking at plants, slides and more. Viewing area measures 2.8(H) x 2.2(dia)cm with a 4(dia)cm base.

NK50721 **\$8.95**



### Giant Folding Magnifier - 50mm Diameter

Giant folding magnifier. Diameter: 50 mm. 6x magnification. Easily held by small or large hands.

SER1153001 **\$4.95**





**Hand Held Magnifier  
- 2x/4x Magnification**

Popular Sherlock Holmes style magnifier. 100mm in diameter with additional spot lens. Magnification: 2x and 4x.

SER1098003

Set of 10 \$4.10



**Hand Magnifiers**

Securely set lens in plastic frame with an easy-to-grip handle. Smallest magnifier is 11cm long (3x and 8x), medium magnifier is 15cm long (3x and 6x) and the largest measures 19cm long (2x and 5x).

FD04038

3x & 8x - 11cm long \$6.95

FD06036

3x & 6x - 15cm long \$10.95



**Magnification Sheet - 3X**

A simple and effective tool for examining plants, rocks and insects, and to improve the legibility of maps, newspapers, books and other objects you would like to see in bigger format. This plastic magnification sheet has 3x magnification and measures 28(L) x 21(H)cm. Ages 3+ years

UB0089

\$9.95



**Jumbo Magnifiers with Stand**

Observe on a grand scale with extra-large magnifiers, sized perfectly for small hands. Flip-out stands on each magnifier allow for engaged, hands-free viewing. Each magnifier's super-safe, plastic lens measures 11.5cm in diameter and offers 4.5x magnification. Set of 6 comes organised in a convenient stand. Magnifiers measure 20cm long.

LER2884

Set of 6 \$79.95



Set of 6  
Save  
**\$21.75**

**Bigjigs - Wooden Magnifying Glass**

This lovely, natural wood magnifying glass is perfect for helping children get closer to nature. Perfectly sized for small hands it measures 12 x 23cm long. It is a set of 6 magnifying glasses.

BJT305

Each \$26.95

BJT305-6K

Set of 6 \$161.70 \$139.95



**Bugnoculars**

Take a closer look! Opens wide to let critters and other insects in and out of the double seal designed to keep the smallest bugs inside. Features water tight bottom to hold water for viewing wet creatures and air holes to keep critters alive. Includes two tweezers.

LL50140

\$14.95



**Invicta - Magnifying Set**

The large magnifying set is ideal for inspecting specimens from nature trips. The millimetre grid on the base of the pot means that the actual size of the specimen is easily recorded. The stand (supplied) also makes it an excellent free-standing desk-top magnifier (lens magnification: x2.3). Supplied with a product guide. The magnifier measures 10 x 11cm.

IP0811

\$39.95

## Biology Tools



### Dissection Set In Wallet

This set is ideal for dissections in anatomical studies. For zoology and anatomical educational use only.

SER1010327 Set of 11 \$39.95



SER1010300



SER1010301

### Scalpel Handles

Basic scalpel handles to be used with scalpel blades.

SER1010300 No. 3 \$4.20  
SER1010301 No. 4 \$4.20



SER1010331



SER1010303



SER1010383



SER1010384



SER1010306

SER1010302

### Scalpel Blades – Pack of 100

Ideal for laboratory use and dissection of parts.

SER1010303	No. 24	\$24.95
SER1010331	No. 15	\$24.95
SER1010384	No. 21	\$24.95
SER1010383	No. 10	\$24.95
SER1010302	No. 23	\$24.95
SER1010306	No. 22	\$24.95



SER1010394



SER1016026



SER1010322

### Forceps

These forceps are ideal to grasp one or many small items simultaneously at any given time, or to hold back small objects such as tissues out of the way to pick up pieces. For educational use only.

SER1010394	Fine Point Curved – 110mm	\$4.95
SER1016026	Plastic Straight – 110mm	\$1.10
SER1010323	Fine Point – 150mm	\$3.95
SER1010397	Fine Point Curved – 130mm	\$3.95
SER1010324	Blunt Point – 160mm	\$3.95
SER1010321	Fine Point – 125mm	\$3.95
SER1010322	Blunt Point 130mm – 130mm	\$3.50



Set of 4  
Save  
**\$11.85**

### Real Working Stethoscope

Listen to the sound of a beating heart. This stethoscope really works! It is made of the highest quality materials to stand up to classroom use.

EN2524-4K Set of 4 \$75.95

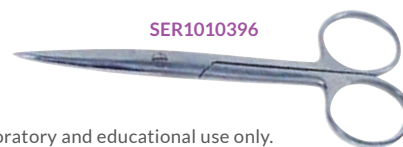

SER1010396

### Dissecting Scissors

Dissecting scissors for laboratory and educational use only.

SER1010396	180mm	\$11.95
SER1010479	140mm	\$11.95
SER1010304	110mm	\$11.95
SER1010305	125mm	\$11.95
SER1010307	130mm	\$11.95



SER1167006



SER1010398

### Probes

These probes are ideal to explore openings and substances.

SER1167008	Eye Blunt – 140mm	\$2.95
SER1010398	Straight Sharp – 130mm	\$2.95
SER1167006	Bent Alloy Handle – 140mm	\$2.95
SER1167007	Alloy Handle – 140mm	\$3.60



NK50804



NK6605-25

### Petri Dishes

Plastic petri dishes with safety lids for intriguing chemical and also biological experiments.

NK50804	90mm x 15mm Pk100	\$37.95
NK6605-25	7cm diameter – 25 Pack	\$15.95

### My First Lab™ Ultimate Microscope

A recently upgraded microscope that is now on a new base with a rechargeable battery light source. The detachable AC power cord can be used to power the light or recharge the battery for portable use "in the field". Its battery lasts for hours and can be recharged hundreds of times for years of valuable scientific research!

DC50710 \$199.95



### My First Lab™ Digital Microscope

Use with the digital eyepiece and connect to a computer via the USB port or with the included standard 10X eyepiece. View live colour images, save, edit, add text and even email! Software compatible with Windows systems supporting USB (Windows 98 and up).

DC50700 \$329.95



### Beginner Microscope

The perfect microscope for primary grades.

EIS0002D \$234.95

#### Features

- Mechanical tube Length: 160mm
- 45° Inclined head
- 360° Rotatable
- Eyepieces: WF 10x
- Achromatic Objectives: 4x, 10x, 40x
- Coarse and fine focus.



### Junior Monocular Microscope – 4/10/40x

This high quality junior microscope uses simpler stage controls and a disc type diaphragm. It still has the beautiful triangular design, coarse and fine, LED lighting, and 10x eyepieces.

SER1122018 \$299.95



### Junior Monocular Microscope – 4/10/40x

Microscope Monocular Junior with mirror & built in light. Glass optics gives a very clear image at a very reasonable price. Image compares with more expensive microscopes!

SER1115997 \$99.95



### Stereoscopic Dual Light Microscope – 20x & 40x

Microscope Features: 20x & 40x dual magnification & light source, inclined body LED illumination with variable light control, dual LED light variable sources, 10x eyepiece wide field, objectives rotate 2x & 4x.

SER1122008 Pack of 50 \$399.95



## Microscopes

### Monocular Senior Microscope – 4/10/40/100x

High quality monocular microscope without the built in digital camera. This model has a modern triangular base design that aids in stability, LED lighting, fine and course focusing with mechanical stage, iris diaphragm, 10x eyepieces and 1.25 abbe condenser.

SER1122019 \$389.95



### Binocular Senior Microscope – 4/10/40/100x

High quality binocular microscope. Explore the world of mini creatures, and discover things we can't see with our eyes. This model has a modern triangular base design that aids in stability, LED lighting, Fine and course focusing with mechanical stage, Iris diaphragm, 10x eyepieces and 1.25 abbe condenser.

SER1122021 \$629.95



### Monocular Senior Microscope – 4/10/40/100x

High quality monocular microscope. This model has a modern triangular base design that aids in stability, LED lighting, fine and course focusing with mechanical stage, iris diaphragm, 10x eyepieces and 1.25 abbe condenser.

SER1122014 \$319.95



### Monocular Junior/Senior Microscope – 4/10/40x

This great monocular microscope is able to be used to view slides or to view solid objects such as leaves, rocks due to its dual lighting system. It has clear high quality optics and 4/10/40 Objectives. It is also portable able to be used on battery power, with long lasting power due to LED lighting.

SER1122032 \$229.95



### Monocular Senior Microscope – Digital

High quality monocular microscope with built in digital camera for whole class viewing on your smart board or monitor. This model has a modern triangular base design that aids in stability, LED lighting, fine and course focusing with mechanical stage, iris diaphragm, 10x eyepieces and 1.25 abbe condenser.

SER1122029 Pack of 50 \$699.95



### Monocular Senior Microscope – Iris Dia LED – 4/10/40x

This high quality senior microscope uses simpler stage controls and a Iris diaphragm. It has the beautiful triangular design, course and fine, LED lighting, and 10x eyepieces.

SER1122018A \$389.95



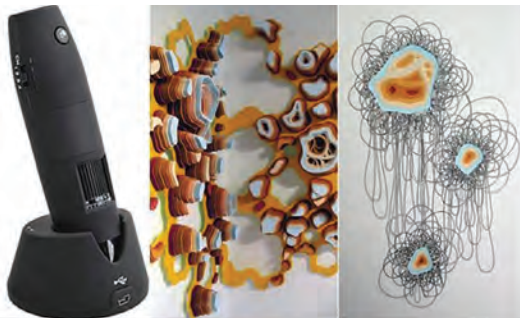

**Handheld Digital Microscope with Stand - 2MP 200x**

This is an amazing and easy to use handheld digital microscope with USB interface. It broke the conception of traditional microscope, it realised these functions: measurement, save, copy, transfer image and video which are difficult for a traditional microscope. It is small, easy to operate and portable fun.

SER5006005

\$98.95

**Stereoscopic Dual Light Microscope - 80x**

Features: 80x magnification and light source, inclined body LED illumination with variable light control, LED light variable sources, 10x eyepiece wide field

SER1122901

\$899.95



**Digital Microscope - USB 5MP with Software**

A USB microscope with a that allows students to make fine adjustments to the vertical height of the microscope and swivel the scope arm around a 360 degree range. The optics built into this microscope are excellent. The sharpness of texture on magnified objects is incredible to look at. It comes with a great piece of software for capturing 5MP (2592x1944) res JPGs, BMPs, TIFFs or PNGs and 1280x960 pixel AVI files. Compatible with WinXP/ Vista/7/8, Mac 10.6-10.8. Magnification ratio: 10x, 300x (at 5MP res). Find full specifications on our website.

EL3199

\$239.95



**Glass Microscope Slide - 75x25mm**

Microscope Slide Blank, Glass, 75 x 25mm. Pack/50.

SER1020031

Pack of 50 \$3.95



Set of 4  
Save  
**\$1985**



**Wireless Digital Microscope - USB**

This extraordinary wireless hand-held digital microscope/camera is easy to use; just connect it to your computer or even your smartphone, simply using the 10m covered WiFi, and start taking videos or photos.

FD079

Each **\$114.95**

FD079-4

wSet of 4 ~~\$459.80~~ **\$439.95**



**Clear Tint Microscope Lamp - 240V 25W**

Lamp Clear Tint, 240V, 25W

SERLB2160-001

\$44.95

## Microscope Slides

### Microscope Slide Sets

Have a deeper look into the microscopic world with these slide sets. The slide sets offer a wide variety of things to explore for kids as well as for higher secondary students.



SER2080105	Animal Tissue – Set of 12	Animal set of 12 common items which includes cerebellum, spinal cord, nerve, artery & vein, cardiac muscle , lymph node , spleen , scalp, skin, cervix , testis and thyroid gland.	\$29.95
SER2080906	Animal Tissues – Circulatory System	Slide set of 10 includes human blood, mammalian blood, frog blood, artery, aorta wall, vein, rat heart, capillaries in lung, lymph vessel, bone marrow.	\$29.95
SER2080907	Animal Tissues – Muscles & Bone	Slide set of 6 includes various animal muscles, bones, bladder and stomach.	\$25.95
SER2080905	Animal Tissues – The Nervous System	Slide set of 10 includes nerve, neurons, spinal cord, cerebellum, hypothalamus, muscle and brain sagittal among other samples.	\$39.95
SER2080903	Animal Tissues Digestive System	Slide set of 12 includes tongue, oesophagus, stomach, colon, rectum, gall bladder, liver, pancreas and salivary gland.	\$49.95
SER2080901	Animal Tissues Skin – Set of 10	Slide set of 10 includes sole of foot, eyelid, finger tip, scalp, hairless skin, sweat glands and hair follicles among other samples.	\$29.95
SER2080904	Animal Tissues Urinogenital System	Slide set of 15 includes ovary, uterus, vaginal wall, testis, urethra, penis, prostate gland, bladder, kidney and more.	\$179.95
SER2080890	Bacterial Types & Cell Division	Slide set of 10 displays various bacterial types and cell division.	\$69.95
SER1197002	Beginners – Set of 12	Slide set of 12 includes housefly wing, butterfly wing scales, water organisms, onion skin, cork section, cotton material, paper fibres, water flea and more.	\$29.95
SER1197006	Biology Basic – Set of 25	Slide set includes amoeba, human blood smear, artery, vein, lung ovary, testis, spirogyra and more.	\$49.95
SER1197007	Biology General – Set of 25	Slide set includes human blood smear, kidney, lung, skin, sweat glands, spinal cord, yeast, dicot stem, monocot leaf epidermis, kidney, pancreas moss leaf and many more.	\$49.95
SER2080899	Biology High School – Set of 20	Slide set includes samples commonly used in high school biology classes.	\$49.95
DC51774	Blood and Guts	Specimens include human stomach, heart, blood, kidney, and brain.	\$14.95
SER1139902	Blood Comparison – Set of 11	Slide set includes bird blood, bovine blood, blood stained fibres, camel blood, frog blood, cat or rabbit blood, human blood, crab blood, reptile blood, sickle cell and sheep blood.	\$39.95
SER2080886	Botanical Basic – Set of 20	Slide set includes spirogyra filaments, chlamydomonas, penicillum v.s on host, saccharomyces, marchantia v.s archegonial head, marchantia v.s antheridial head, moss v.s archegonial head, moss v.s antheridial head etc.	\$59.95

Detailed information of slides present in each set are available on [www.teaching.com.au](http://www.teaching.com.au)

SER1197012	Botanical Basic – Set of 25	Slide set includes moss, spirogyra, mucor, yeast, penicillium, fern, zea root, cheery leaf and many more.	\$59.95
SER1197010	Cell Division: Mammal Testis TS	Slide set shows examples of mitosis, meiosis, spermatogenesis, insect salivary gland and more.	\$49.95
SER1198999	Commonly Found Items – Set of 12	Slide set contains insect debris, glass, sand, charcoal, salt, crystal, sugar, cornflour, silk , polycotton and more.	\$19.95
DC51775	Creepy Crawlies	The set of five prepared slides include a honeybee mouth, mosquito leg, ant, planaria, and an earthworm.	\$14.95
SER1197021	Earthworm – Set of 6	Slide set shows various parts of the earthworm.	\$15.95
DC51776	Edible Plants	Specimens include onion root, corn stem, tomato leaf, carrot root and rice leaf.	\$14.95
DC51777	Extraordinary Ordinary	Five slides showing common household objects like you have never seen before. What do hair, cork, fibres and other objects look like under a microscope?	\$14.95
DC51779	Flower Power	Specimens include sunflower stem, buttercup stem, lily leaf, lotus root, and also rose petal.	\$14.95
SER1197005	Food Science – Set of 20	Slide set shows meat cooked and uncooked, collagen , fish cooked and uncooked, bacteria, yeast, penicillium, potato cooked and uncooked, onion skin, carrot, flour, starch grains and more.	\$49.95
DC51780	Fun Guys	Specimens include rhizpous (bread mold), penicillum lichens, coprinus (mushroom) and saccharomyces (yeast).	\$14.95
SER2080089	Hair Examples – Set of 12	Slide set includes hair of rabbit, cat, dog, sheep, pig, horse, cow, human, bird feather, peafowl, duck and chick.	\$9.95
SER2080896	Histology Basic – Set of 24	Slide set includes oesophagus, intestine, mouth cells, adipose tissue, cartilage, bone, muscle, fibrous tissue, kidney, ovary ,testis and more.	\$59.95
SER1066901	Histology Basic – Set of 50	Slides set includes stigma, stem, hydra with testis, tapeworm, striated muscle and more.	\$99.95
SER1197028	Histology Human – Set of 25	Slide set includes cerebellum, spinal cord, nerve, artery vein, cardiac muscle and many more.	\$59.95
SER1197020	Hydra – Set of 6	Slide set includes hydra with ingested animal, hydra with bud, hydra with testis, hydra with ovary and more.	\$29.95
SER2080889	Insect Anatomy – Set of 20	Slide set includes trachea, gizzard, wing scales, wings-fly, bee, grasshopper, bee sting, legs, flea, cornea, trachea and more.	\$59.95
SER1197022	Insect Anatomy – Set of 9	Slide set includes parts of cockroach, butterfly, housefly. Anatomy parts include antenna, wings, legs, head, eyes,apis, and more.	\$29.95
SER2080888	Insect Morphology – Set of 20	Slide set includes various insect parts such as larva, pupa, head of mosquito, house fly, cockroach, honey bee, beetle and more.	\$69.95
DC51783	Intermediate – Set of 25	Unique specimens include hair, sugar, pepper, yeast, fly head, fish skin, human blood, cotton stem, cotton leaf, hydra, sprout, muscle.	\$49.95
SER2080885	Introduction to Microscopy – Set 12	Slide set includes human hair, wool, nylon, crystal, dust, blood, insect leg, insect wing, plant cell, animal cell and more.	\$19.95

Detailed information of slides present in each set are available on [www.teaching.com.au](http://www.teaching.com.au)

## Microscope Slide Sets

SER1103024	Life In A Pond	Slide set includes blue alga, green alga, hydra, freshwater oligochaetes and more.	\$69.95
DC51778	Lily Pad Leap	Specimens include frog intestine, kidney, liver, skin and lung.	\$14.95
SER2080897	Mammalian Embryology – Set of 3	Slide set includes mouse & early development head, torax and abdomen.	\$59.95
SER2080898	Mammalian Embryology Mouse – Set of 8	Slide set includes head through brain region, eye region, thorax, abdomen, foetus, umbilical cord of mouse	\$89.95
SER1197009	Mixed Bacteria – Set of 12	Slide set includes bacilli, cocci, spirillum, gram positive and negative, myobacterium tuberculosis in tissue, rhizobium in root nodule and more.	\$69.95
SER2080900	Parasitology Basic – Set of 12	Slide set includes hookworm, tapeworm, tick mouth parts, flea, louse and more	\$199.95
SER2080894	Plant Anatomy & Adaption – Set of 24	Slide set includes root hairs showing root cap, eucalyptus isobilateral leaf, mangrove leaf salt adaption, gymnosperm, angiosperm of leaf and more.	\$249.95
SER1197014	Plant Anatomy Basic – Set of 20	Slide set includes vicia root apex, zea (maize) stem, dicot stem, stigma with pollen tubes.	\$39.95
SER2080106	Pond Life Australian – Set 12	Slide set includes spirogyra, green filamentous alga, an ostracod, cyclops, a copepod and more.	\$129.95
DC51773K	Prepared – 40pc	This is a great complete prepared slide set for examining animals as well as plant tissues.	\$113.95
DC51782	Prepared – 12p	Unique specimens include cotton, nylon, corn starch, salt, wool, silk, pumpkin, honey bee, pollen, bird feathers, hydra and also frog blood smear.	\$28.95
SER1052961	Prepared General Biology Slides – Set 100	Slide set includes plant root tip, stems and seeds of plants, leaves, moss, penicillium, mouth cell, muscles, artery & vein. Blood smear, animal mouth parts, earthworm and more	\$132.95
SER1197008	Protozoa & Algae – Set of 20	Slide set includes amoeba, paramecium, filaments with heterocysts, spirogyra, vegetative filaments and more.	\$79.95
SER1197004	Textiles – Set of 12	Slide set includes wool, polyester fibre, nylon, yak hair, cotton, linen and more.	\$22.95
SER1197015	Timber Sections Mixed – Set of 12	Slide set includes Scots pine, African mahogany, English oak, red cedar, teak, birch, beech, fir, sycamore, lime and more.	\$29.95
SER2080908	Tissue Glands & Endocrine System	Slide set includes pancreas, thyroid, parathyroid, adrenal, pituitary, lymph, parotid, prostate and more.	\$39.95
DC51773	Wicked Wings	Specimens include mosquito wing, housefly wing, fruit fly wing, butterfly wing and a bee wing.	\$14.95
SER2080895	Zoology & Histology Basic – Set of 35	Slide set includes various basic and advaced zoology and histology slides.	\$399.95
SER1197018	Zoology Basic – Set of 25	Slide set includes parts of amoeba, tapeworm, round worm, butterfly, rabbit, frog and more.	\$89.95
SER2080887	Zoology Basic Animal Kingdom	Slide set includes hydra with bud, obelia hydroid colony, ancylostoma (hookworm) and more.	\$69.95

*Detailed information of slides present in each set are available on [www.teaching.com.au](http://www.teaching.com.au)*



## Microscope Slides

SER2080131	Slide – Allium (Onion) Root Tip L.S.	\$7.95
SER2080211	Slide – Allium Epidermis Onion Bulb WM	\$7.95
SER2080212	Slide – Allium Leaf Epidermis Shows Stomate	\$7.95
SER2080130	Slide – Allium Onion Root Tip for Mitosis L.S.	\$7.95
SER1117001	Slide – Minigrid Slide – Central Printed Area – 1cmx1cm	\$17.95
SER2080687	Slide – Adipose Tissue Section	\$9.50
SER2080846	Slide – Adrenal Details of Cortex and Medulla	\$7.95
SER2080064	Slide – Agaricus Mushroom	\$7.95
SER2080065	Slide – Agaricus Mushroom Basidiomycetes	\$7.95
SER2080305	Slide – Amoeba Proteus WM	\$11.95
SER2080544	Slide – Amphioxus TS Female Gonads	\$9.95
SER2080541	Slide – Amphioxus TS intestine	\$9.95
SER2080543	Slide – Amphioxus TS Male Gonads	\$9.95
SER2080545	Slide – Amphioxus Young Adult WM	\$19.95
SER2080374	Slide – Ancylostoma Adult Female Hook Worm WM	\$16.95
SER2080373	Slide – Ancylostoma Adult Male WM	\$16.95
SER2080330	Slide – Anemona TS & LS	\$11.95
SER2080630	Slide – Animal Cell Generalised	\$7.95
SER2080634	Slide – Animal Meiosis Spermatogenesis	\$7.95
SER2080632	Slide – Animal Mitosis LS Sec IH	\$7.95
SER2080823	Slide – Aorta TS	\$7.95
SER2080824	Slide – Aorta TS Human	\$7.95
SER2080686	Slide – Areolar Tissue	\$11.95
SER2080822	Slide – Artery	\$7.95
SER2080828	Slide – Artery & Vein TS	\$7.95
SER2080827	Slide – Artery Vein & Nerve	\$7.95
SER2080366	Slide – Ascaris Female CS	\$7.95
SER2080368	Slide – Ascaris General Body Structure TS	\$9.95
SER2080365	Slide – Ascaris Male Thru Reproductive Region	\$7.95
SER2080367	Slide – Ascaris Through Oesophagus TS	\$9.95
SER2080050	Slide – Aspergillus Brown Mould of Conidia	\$7.95
SER2080328	Slide – Aurelia Ephyra Stage WM	\$12.95
SER2080868	Slide – Bacillus Subtilis	\$7.95
SER2080865	Slide – Bacteria; Cocci Bacilli & Spirilli	\$7.95
SER2080477	Slide – Beetle Mouth Parts WM	\$7.95
SER2080765	Slide – Bile Duct TS Extra Hepatic Region	\$9.50
SER2080595	Slide – Bird Anatomy Blood	\$9.50
SER2080598	Slide – Bird Anatomy Contour Feather	\$9.95
SER2080599	Slide – Bird Anatomy Down Feather	\$9.95

## Microscope Slides

SER2080596	Slide - Bird Anatomy Lung	\$9.50
SER2080600	Slide - Bird Anatomy Ovary	\$9.50
SER2080597	Slide - Bird Anatomy Skin	\$9.50
SER2080601	Slide - Bird Anatomy Testis	\$9.50
SER2080800	Slide - Bladder Rat VS	\$9.50
SER2080712	Slide - Blood Amphibian Smear	\$7.95
SER2080709	Slide - Blood Human Anemia with Leucocyte	\$14.95
SER2080708	Slide - Blood Human Female Sex Chrom.	\$7.95
SER2080155	Slide - Blood Human Normal Smear	\$9.95
SER1197220	Slide - Blood Human Thin Film Wrights Stain	\$7.95
SER2080714	Slide - Blood Mammal Smear	\$7.95
SER2080711	Slide - Blood Reptile Smear	\$7.95
SER2080710	Slide - Blood Smear Bird	\$7.95
SER2080713	Slide - Blood Smear Fish	\$7.95
SER2080703	Slide - Bone Marrow Smear	\$7.95
SER2080424	Slide - Brine Shrimp WM	\$9.95
SER2080485	Slide - Butterfly Head Sucking Probe WM	\$7.95
SER2080486	Slide - Butterfly Wing Scales Isolat WM	\$7.95
SER2080734	Slide - Cerebellum Layers of the Cortex	\$7.95
SER2080735	Slide - Cerebral Cortex	\$7.95
SER2080602	Slide - Chick 12/16hrs Prim. Streak WM	\$23.95
SER2080603	Slide - Chick 18 Hrs Form. Notocord	\$23.95
SER2080606	Slide - Chick 24 Hrs 4-7 Somites WM	\$23.95
SER2080609	Slide - Chick 33 Hrs 10-14 Somites WM	\$23.95
SER2080612	Slide - Chick 40 Hrs 15-23 Somites WM	\$23.95
SER2080613	Slide - Chick 48 Hrs 24-28 Somites WM	\$23.95
SER2080616	Slide - Chick 60 Hrs 29-32 Somites	\$23.95
SER2080619	Slide - Chick 72 Hrs 33-37 Somites	\$23.95
SER2080622	Slide - Chick 96 Hrs 38-41 Somites	\$23.95
SER2080009	Slide - Chlamydomonas	\$7.95
SER2080268	Slide - Chloroplasts TS Leaf Stained	\$7.95
SER1197227	Slide - Chromosomes Human Down's Syndrome	\$29.95
SER2080680	Slide - Cilated Epithelium Frogs Palate	\$9.50
SER2080679	Slide - Cilated Epithelium TS Oviduct	\$9.50
SER2080345	Slide - Clonorchis Sinensis Human Flu WM	\$34.95
SER2080854	Slide - Cochlea Details of Inner Ear	\$7.95
SER1197367	Slide - Cochlea Guinea Pig VS	\$7.95
SER2080438	Slide - Cockroach Head Entire	\$7.95
SER2080439	Slide - Cockroach or Grasshopper	\$19.95
SER2080183	Slide - Coleus	\$9.95

SER2080181	Slide – Coleus Stem T.S.	\$7.95
SER2080762	Slide – Colon TS Large Goblet Cells	\$9.50
SER2080314	Slide – Commercial Sponge Teased & Stained	\$9.95
SER2080702	Slide – Compact Bone Ground Preparation	\$7.95
SER2080701	Slide – Compact Bone LS	\$7.95
SER2080700	Slide – Compact Bone TS Decalcified St.	\$7.95
SER2080913	Slide – Corn Stem CS	\$7.95
SER2080860	Slide – Cornea Fibrous Tissue and Membrane	\$7.95
SER2080426	Slide – Crab Zoea Larva WM	\$15.95
SER2080418	Slide – Crayfish Abdomen TS	\$9.95
SER2080419	Slide – Crayfish Crustacea Section	\$9.95
SER2080557	Slide – Ctenoid Scales WM	\$9.95
SER2080196	Slide – Cucurbita (Pumpkin) L.S. Stem	\$7.95
SER2080184	Slide – Cucurbita Pumpkin Stem	\$7.95
SER2080187	Slide – Cuscuta Dodder Through Haustorium	\$7.95
SER2080001	Slide – Cyanobacteria Anabaena	\$9.95
SER2080556	Slide – Cycloid Scales	\$9.95
SER2080420	Slide – Cyclops Cepopod Whole Mount	\$9.95
SER2080422	Slide – Cypris Ostracod Whole Mount	\$9.95
SER2080275	Slide – Cystoliths TS Leaf	\$9.95
SER2080421	Slide – Daphnia Cladocera Whole Mount	\$9.95
SER2080148	Slide – Daucus Carrot	\$9.95
SER2080029	Slide – Deciduous & Evergreen Comparison	\$7.95
SER2080018	Slide – Desmids Mixed Sample	\$7.95
SER2080696	Slide – Developing Cartilaginous Bone	\$11.95
SER2080697	Slide – Developing Membranous Bone	\$11.95
SER2080749	Slide – Developing Tooth LS Pig Foetus	\$14.95
SER2080225	Slide – Dianthus (Carnation) Leaf TS	\$7.95
SER1197590	Slide – Diplococcus Pneumoniae	\$7.95
SER2080353	Slide – Dipylidium Scolex Caninum Whole Mount	\$29.95
SER2080354	Slide – Dipylidium Scolex Mature and Gravid	\$51.95
SER2080554	Slide – Dogfish Section Spiral Valve	\$9.95
SER2080553	Slide – Dogfish VS Through Skin	\$9.95
SER2080227	Slide – Drosera (Sundew) TS Leaf Showing	\$7.95
SER2080636	Slide – Drosophila Chromosomes	\$7.95
SER2080041	Slide – Drosophila Life Cycle	\$7.95
SER2080273	Slide – Druce Crystals TS Stem	\$9.95
SER2080759	Slide – Duodenum Brunners Intestinal Glands	\$9.50
SER2080355	Slide – Echinococcus Granulosus of Entire Worm	\$34.95
SER2080694	Slide – Elastic Cartilage	\$9.50

## Microscope Slides

SER2080214	Slide – Elodea Leaf Whole Mount	\$7.95
SER2080213	Slide – Elodea of Stem Tip LS	\$7.95
SER2080160	Slide – Elodea T.S. Aquatic Plant	\$7.95
SER2080772	Slide – Epiglottis	\$9.50
SER2080676	Slide – Epithelium Simple Cuboidal Sect	\$9.50
SER2080672A	Slide – Epithelium Squamous – Human Mouth	\$7.95
SER2080672	Slide – Epithelium Squamous Human Mouth	\$7.95
SER2080675	Slide – Epithelium Squamous Simple	\$7.95
SER2080673	Slide – Epithelium Squamous Stratified	\$7.95
SER2080671	Slide – Epithelium Transitional	\$9.50
SER2080674	Slide – Epithelium Whole Mount Frogs Skin	\$9.50
SER2080220	Slide – Erica Rolled Xerophytic Leaf TS	\$7.95
SER2080866	Slide – Escherichia Coli	\$7.95
SER2080230	Slide – Eucalyptus TS Bifacial Leaf	\$9.95
SER2080294	Slide – Eucalyptus Wood	\$9.95
SER2080008	Slide – Euglena Stained	\$7.95
SER2080307	Slide – Euglena Whole Mount	\$7.95
SER2080853	Slide – External Ear	\$7.95
SER2080859	Slide – Eye Median Horizontal Section	\$7.95
SER2080048	Slide – Eyelid Primate	\$7.95
SER2080343	Slide – Fasciola Hepatica Cercarise	\$16.95
SER2080336	Slide – Fasciola Hepatica Fluke of s WM	\$7.95
SER2080339	Slide – Fasciola Hepatica LS	\$9.95
SER2080341	Slide – Fasciola Hepatica Miracidia	\$16.95
SER2080344	Slide – Fasciola Hepatica Sporocyst	\$16.95
SER2080338	Slide – Fasciola Hepatica TS in Situ	\$9.95
SER2080337	Slide – Fasciola Hepatica TS thru Two R	\$9.95
SER2080340	Slide – Fasciola Hepatica Whole Mount of Ova	\$9.95
SER2080342	Slide – Fasciola Hepatica Whole Mount Redia	\$16.95
SER2080103	Slide – Fern Prothallium	\$7.95
SER2080100	Slide – Fern Prothallium of Antheridia WM	\$7.95
SER2080101	Slide – Fern Prothallium W.M. of Archegonium	\$7.95
SER2080288	Slide – Fern Rhizome	\$9.95
SER2080098	Slide – Fern Sporangia v.s. through Sorus	\$7.95
SER2080695	Slide – Fibrocartilage TS	\$9.50
SER2080234	Slide – Ficus (Fig) TS Leaf-Cutstomepid	\$7.95
SER2080149	Slide – Ficus Elastica Rubber Tree	\$9.95
SER2080125	Slide – First Year Female Cone At Pollination	\$9.95
SER2080028	Slide – Floating TS Leaf Nymphaea and Elodea	\$11.95
SER2080432	Slide – Freshwater Mite Whole Mount	\$7.95

SER2080392	Slide – Freshwater Oligochaetes	\$9.95
SER2080570	Slide – Frog Anatomy Ovary	\$9.50
SER2080575	Slide – Frog Anatomy Skin TS	\$9.50
SER2080574	Slide – Frog Anatomy Skin Unstained	\$9.50
SER2080573	Slide – Frog Anatomy Skin Whole Mount	\$9.50
SER2080572	Slide – Frog Anatomy Sperm Smear TS	\$9.50
SER2080576	Slide – Frog Anatomy Stomach	\$9.50
SER2080571	Slide – Frog Anatomy Testis	\$9.50
SER2080562	Slide – Frog Blood Smear	\$7.95
SER2080563	Slide – Frog Body Fat	\$9.50
SER2080588	Slide – Frog Embryology – Neural Tube	\$11.95
SER2080590	Slide – Frog Embryology 10mm Embryo	\$14.95
SER2080589	Slide – Frog Embryology 5-6mm Embryo	\$14.95
SER2080583	Slide – Frog Embryology Blastula	\$9.50
SER2080581	Slide – Frog Embryology Early Cleavage	\$9.50
SER2080584	Slide – Frog Embryology Early Gastrula	\$9.50
SER2080582	Slide – Frog Embryology Late Cleavage	\$9.50
SER2080587	Slide – Frog Embryology Neural Fold	\$9.50
SER2080586	Slide – Frog Embryology Neural Plate	\$9.50
SER2080580	Slide – Frog Embryology Uncleaved Egg	\$9.50
SER2080585	Slide – Frog Embryology Yolk Plug	\$9.50
SER2080566	Slide – Frog Kidney	\$9.50
SER2080565	Slide – Frog Large Intestine	\$9.50
SER2080567	Slide – Frog Lung	\$9.50
SER2080569	Slide – Frog Oesophagus	\$9.50
SER2080568	Slide – Frog Roof of Mouth	\$9.50
SER2080564	Slide – Frog TS Small Intestine	\$9.50
SER2080025	Slide – Fucus Female Conceptacle Microsporangia	\$7.95
SER2080024	Slide – Fucus Male Conceptacle Microsporangia	\$7.95
SER2080764	Slide – Gall Bladder Mucosa Showing Layers	\$9.50
SER2080423	Slide – Gammarus Amphipod Whole Mount	\$9.95
SER2080558	Slide – Ganoid Scales	\$9.95
SER2080380	Slide – Glochidia of Clam Larval Form.	\$9.95
SER2080766	Slide – Glycogen in Liver	\$9.50
SER2080642	Slide – Golgi Complex	\$15.95
SER2080312	Slide – Grantia LS Body & Osculam	\$9.95
SER2080313	Slide – Grantia Spicules Isolated Ca	\$9.95
SER2080311	Slide – Grantia TS Canals & Spicules	\$9.95
SER2080218	Slide – Grass Leaf TS	\$7.95
SER2080229	Slide – Grevillea Leaf TS	\$7.95

## Microscope Slides

SER2080032	Slide - Gymnosperm and Angiosperm	\$11.95
SER2080375	Slide - Haemonchus of Stomach Worm	\$12.95
SER2080813	Slide - Hair Bat	\$7.95
SER2080814	Slide - Hair Cat	\$7.95
SER2080815	Slide - Hair Cow	\$7.95
SER2080816	Slide - Hair Dog	\$7.95
SER2080067	Slide - Hair Dog (Poodle)	\$7.95
SER2080070	Slide - Hair Goat	\$7.95
SER2080076	Slide - Hair Human - Grey	\$7.95
SER2080087	Slide - Hair Human Melanesian	\$7.95
SER2080077	Slide - Hair Human Negroid	\$7.95
SER2080819	Slide - Hair Human Normal	\$7.95
SER2080817	Slide - Hair Marsupial	\$7.95
SER2080071	Slide - Hair Camel	\$7.95
SER2080818	Slide - Hair Sheep	\$7.95
SER2080826	Slide - Heart M.S. From Mouse	\$9.50
SER2080063	Slide - Heartworm Dog	\$14.95
SER2080020	Slide - Helianthus (Sunflower) LS Stem	\$7.95
SER2080231	Slide - Helianthus (Sunflower) TS Leaf	\$7.95
SER2080192	Slide - Helianthus (Sunflower) TS Old Stem	\$7.95
SER2080191	Slide - Helianthus Old Stem TS	\$7.95
SER2080019	Slide - Helianthus Sunflower TS & LS	\$7.95
SER2080151	Slide - Helianthus T.S. Old Root	\$7.95
SER2080150	Slide - Helianthus TS Young Root	\$7.95
SER2080180	Slide - Hibiscus L.S. Stem	\$7.95
SER2080468	Slide - Honeybee Head of Worker with Mouth	\$7.95
SER2080471	Slide - Honeybee Pollen Basket	\$7.95
SER2080472	Slide - Honeybee Sting with Poison Sac	\$7.95
SER2080459	Slide - Housefly Head with Proboscis	\$7.95
SER2080638	Slide - Human Female Chromosomes	\$7.95
SER1197312	Slide - Human Lung TS	\$7.95
SER2080637	Slide - Human Male Chromosomes	\$7.95
SER2080693	Slide - Hyaline Cartilage	\$9.50
SER2080323	Slide - Hydra LS	\$9.95
SER2080322	Slide - Hydra TS	\$9.95
SER2080319	Slide - Hydra TS Specimen with Testes	\$9.95
SER2080316	Slide - Hydra Whole Mount	\$7.95
SER2080317	Slide - Hydra Whole Mount Individual Bud	\$7.95
SER2080320	Slide - Hydra Whole Mount with Ovaries	\$12.95
SER2080318	Slide - Hydra Whole Mount with Testes	\$12.95

SER2080361	Slide – Hymenolepis Whole Mount of Scolex	\$44.95
SER2080736	Slide – Hypothalamus	\$7.95
SER2080761	Slide – Ileum TS Shows Peyers Patches	\$9.50
SER2080495	Slide – Insect Anatomy Antennae – 7 Types	\$19.95
SER2080494	Slide – Insect Anatomy Antennae Comp	\$9.95
SER2080490	Slide – Insect Anatomy Cornea Mounted F	\$9.95
SER2080506	Slide – Insect Anatomy Flea Larva	\$15.95
SER2080504	Slide – Insect Anatomy Flea Whole Mount	\$19.95
SER2080489	Slide – Insect Anatomy Ganglion With Nerve	\$9.95
SER2080496	Slide – Insect Anatomy Haematopinus Suis	\$19.95
SER2080497	Slide – Insect Anatomy Haematopinus Suis	\$19.95
SER2080498	Slide – Insect Anatomy Haematopinus Suis	\$15.95
SER2080488	Slide – Insect Anatomy Malphigian Tubes	\$9.95
SER2080499	Slide – Insect Anatomy Pediculus humanus	\$19.95
SER2080500	Slide – Insect Anatomy Pediculus humanus	\$19.95
SER2080492	Slide – Insect Anatomy Spiricale Whole Mount	\$9.95
SER2080491	Slide – Insect Anatomy Trachea Stained	\$9.95
SER2080039	Slide – Insect Mouthparts Butterfly	\$7.95
SER2080482	Slide – Insect Mouthparts Grasshopper	\$7.95
SER2080481	Slide – Insect Mouthparts Housefly	\$7.95
SER2080856	Slide – Iris Pigmented Epithelium	\$7.95
SER2080760	Slide – Jejunum	\$9.50
SER2080799	Slide – Kidney Carmine Gelatin Injected	\$11.95
SER2080797	Slide – Kidney General Structure	\$7.95
SER2080798	Slide – Kidney Median Entrance of Ureter	\$7.95
SER2080122	Slide – L.S. First Year Female Cone	\$9.95
SER2080118	Slide – L.S. Male Cone with Pollon	\$9.95
SER2080124	Slide – L.S. Ovule	\$9.95
SER2080243	Slide – Leaf Epidermis Comparison	\$7.95
SER2080235	Slide – Leaf Nymphaea Floating Air Chambers TS	\$7.95
SER2080893	Slide – Leaf Structure – Set of 35	\$399.95
SER2080242	Slide – Leaf Types Hydrophitic Mesop TS	\$7.95
SER2080389	Slide – Leech General Structures T.S.	\$9.95
SER2080388	Slide – Leech Well Expanded Whole Mount	\$7.95
SER2080277	Slide – Lenticels	\$7.95
SER2080529	Slide – Leptosynapta	\$9.95
SER2080310	Slide – Leucosolenia Whole Mount	\$9.95
SER2080069	Slide – Lichen	\$7.95
SER2080068	Slide – Lichen Section through Thallus	\$7.95
SER2080232	Slide – Ligustrum (Privet) Typical Stem TS	\$7.95

## Microscope Slides

SER2080258	Slide - Lilium Anther Early Prophase TS	\$7.95
SER2080259	Slide - Lilium Anther Late Prophase TS	\$7.95
SER2080215	Slide - Lilium Leaf TS	\$7.95
SER2080261	Slide - Lilium Leaf TS	\$7.95
SER2080263	Slide - Lilium Squash for Meiotic Figure	\$7.95
SER2080262	Slide - Lilium Whole Mount Mature Pollen	\$7.95
SER2080161	Slide - Lilium T.S. Stem	\$7.95
SER2080137	Slide - Lilium Typical Monocot Root T.S.	\$7.95
SER2080049	Slide - Lip Primate	\$7.95
SER2080767	Slide - Liver Section Hepatic Cells	\$7.95
SER2080407	Slide - Lumbricus Median Anterior LS	\$9.95
SER2080405	Slide - Lumbricus TS Intestine	\$9.95
SER2080776	Slide - Lung Bird	\$9.50
SER2080775	Slide - Lung Frog	\$9.50
SER2080774	Slide - Lung Mammalian	\$7.95
SER2080096	Slide - Lycopodium TS Stem	\$11.95
SER2080833	Slide - Lymph Gland Section	\$7.95
SER1197805	Slide - Macrophage	\$19.95
SER2080057	Slide - Mammary Gland Primate Resting.	\$7.95
SER2080154	Slide - Mangrove T.S. Aerial Root	\$7.95
SER2080429	Slide - Mangrove Leaf for Salt Diocotledonae	\$7.95
SER2080188	Slide - Mangrove T.S. Stem	\$9.95
SER2080074	Slide - Marchantia v.s. of Antheridia	\$7.95
SER2080075	Slide - Marchantia v.s. through Sporophyte	\$7.95
SER2080428	Slide - Marine Plankton General Study Guide.	\$15.95
SER2080119	Slide - Median L.S. of Male Cone	\$9.95
SER2080737	Slide - Medulla Oblongata	\$7.95
SER1197594	Slide - Meiosis Grasshopper Testis Squash	\$7.95
SER2080641	Slide - Mitochondria	\$7.95
SER1139151	Slide - Mitochondria Amphiuma	\$7.95
SER2080278	Slide - Mitochondria TS Onion Root Tip	\$7.95
SER2080279	Slide - Mitosis Onion Root Tip Squash.	\$7.95
SER2080005	Slide - Mixed Blue - Green Alga - Mixed Sample	\$7.95
SER2080079	Slide - Mniium TS Leaf Showing Chloroplasts	\$7.95
SER2080351	Slide - Moniezia Expansa Scolex Mat	\$51.95
SER2080350	Slide - Moniezia Expansa Whole Mount Scolex	\$24.95
SER2080205	Slide - Monocot & Dicot Comparison Stem TS	\$7.95
SER2080244	Slide - Monocot & Dicot Leaf Compar. TS	\$7.95
SER2080140	Slide - Monocot and Dicot Comparison TS	\$7.95
SER2080037	Slide - Monocot and Dicot. Comp. Lower Buds	\$7.95



SER2080141	Slide – Monocot Dicot and Cryptogam Root	\$7.95
SER2080206	Slide – Monocot Dicot Crypt Stem	\$7.95
SER2080456	Slide – Mosquito Anopholes Female Head	\$7.95
SER2080455	Slide – Mosquito Anopholes Male Head	\$7.95
SER2080454	Slide – Mosquito Culex Female Head	\$7.95
SER2080062	Slide – Mosquito Male Whole Mount	\$7.95
SER2080078	Slide – Moss w.m. of Protonema	\$7.95
SER2080731	Slide – Motor Nerve Endings	\$7.95
SER2080727	Slide – Motor Neurons Ox Spinal Cord	\$7.95
SER2080732	Slide – Motor Plates	\$7.95
SER2080738	Slide – Mouse Brain Medium Sagital	\$7.95
SER2080690	Slide – Mouse Tail Conn. Tissues	\$9.50
SER2080045	Slide – Mucor of Zygosproe Formation	\$7.95
SER2080044	Slide – Mucor W.M of Sporangia	\$7.95
SER2080723	Slide – Muscle Cardiac	\$7.95
SER2080425	Slide – Nauplius Larva Whole Mount	\$15.95
SER2080390	Slide – Nereis General Structures TS	\$9.95
SER2080391	Slide – Nereis Parapodia Whole Mount	\$9.95
SER2080739	Slide – Nerve Mylinated	\$9.50
SER2080728	Slide – Nerve Peripheral	\$7.95
SER2080066	Slide – Nipple Primate	\$7.95
SER2080002	Slide – Nostoc Cyanophyceae Whole Mount	\$9.95
SER2080698	Slide – Notochord TS Shark Embryo	\$9.50
SER2080189	Slide – Nymphaea Water Lily T.S. Aquatic Stem	\$7.95
SER2080324	Slide – Obelia Hydroid Colony Hydrozoa	\$12.95
SER2080325	Slide – Obelia Whole Mount Medusae	\$7.95
SER2080751	Slide – Oesophagus TS	\$7.95
SER2080752	Slide – Oesophagus Stomach Junction	\$9.50
SER2080855	Slide – Optic Nerve Bundles of Nerve Fibre	\$7.95
SER2080190	Slide – Opuntia YS Succulent Stem	\$9.95
SER2080003	Slide – Oscillatoria	\$9.95
SER2080780	Slide – Ovary General Structure	\$7.95
SER2080781	Slide – Ovary Mammalian Corpus Luteum	\$7.95
SER2080785	Slide – Oviduct TS	\$9.95
SER2080757	Slide – Pancreas	\$9.95
SER2080914	Slide – Paramecium Caudatum Conjugation	\$7.95
SER2080915	Slide – Paramecium Multimicro Nucleatum	\$7.95
SER2080308	Slide – Paramecium Whole Mount	\$7.95
SER2080280	Slide – Parenchyma	\$9.95
SER2080838	Slide – Parotid Gland	\$9.95

## Microscope Slides

SER2080236	Slide - Pelargonium TS Leaf	\$7.95
SER2080052	Slide - Penicillium Blue Mold	\$7.95
SER2080053	Slide - Penicillium of Conidiophores	\$7.95
SER2080796	Slide - Penis Rat Corpora Caverosa	\$9.95
SER2080640	Slide - Peripheral Blood	\$7.95
SER2080835	Slide - Peyers Patches	\$9.95
SER2080054	Slide - Peziza Section of Apothecium Asci	\$7.95
SER1197158	Slide - Phagocytosis (Sect) TB & NFR Liver	\$7.95
SER2080147	Slide - Phaseolus (Bean) T.S. Root	\$7.95
SER1197803	Slide - Phloem CS	\$7.95
SER1197804	Slide - Phloem LS	\$7.95
SER2080670	Slide - Pigmented Epithelium TS Iris	\$9.50
SER2080110	Slide - Pinus First Year Stem T.S.	\$9.95
SER2080115	Slide - Pinus Leaf - 2 Needle Type T.S.	\$9.95
SER2080116	Slide - Pinus Leaf - 3 Needle Type T.S.	\$9.95
SER2080117	Slide - Pinus Leaf Gymnospermae - 5 Needle Leaf	\$9.95
SER2080120	Slide - Pinus Male Cone T.S.	\$9.95
SER2080111	Slide - Pinus Older Stem Annual Rings T.S.	\$9.95
SER2080113	Slide - Pinus Primary Root of Seeding T.S.	\$9.95
SER2080114	Slide - Pinus Root T.S.	\$9.95
SER2080123	Slide - Pinus TS First Year Female Cone	\$9.95
SER2080289	Slide - Pinus Wood	\$9.95
SER2080843	Slide - Pituary	\$9.95
SER2080786	Slide - Placenta TS Shows Chorionic Villi.	\$9.95
SER2080555	Slide - Placoid Scales Whole Mount Shark Skin	\$9.95
SER2080333	Slide - Planaria Stained General Structure	\$7.95
SER2080334	Slide - Planaria TS Anterior Posterior	\$9.95
SER2080476	Slide - Plant Bug Whole Mount for Mouth Parts	\$7.95
SER2080270	Slide - Plant Cytology Cork Cells Tilia	\$7.95
SER2080257	Slide - Plant Meiosis Liliium Flower Bud TS	\$7.95
SER2080056	Slide - Plantar Skin Primate	\$9.95
SER1197042	Slide - Plasmodium Falciparum	\$11.95
SER1197802	Slide - Plasmodium Malaria	\$29.95
SER1197041	Slide - Plasmodium Vivax	\$11.95
SER2080012	Slide - Pleurococcus Single Cells	\$7.95
SER2080252	Slide - Pollen Tubes	\$7.95
SER2080250	Slide - Pollen Whole Mount Various Mixed	\$7.95
SER2080216	Slide - Potamogeton TS Aquatic Leaf	\$7.95
SER2080909	Slide - Primate & Hm Histology - Set of 50	\$599.95
SER2080803	Slide - Prostate Gland Primate	\$9.95

SER2080430	Slide – Protozoa Mixed Species Whole Mount	\$7.95
SER2080682	Slide – Pseudostrat.Cil.Col.Epithelium	\$9.50
SER2080058	Slide – Puccinia Graminae through Aecia	\$7.95
SER2080059	Slide – Puccinia Graminae through Uredia	\$7.95
SER2080185	Slide – Pumpkin (Cucurbita) L.S. Stem	\$7.95
SER2080186	Slide – Pumpkin (Cucurbita) Macerated Stem	\$7.95
SER2080251	Slide – Pumpkin (Cucurbita) Pollen	\$9.95
SER1197512	Slide – Pumpkin (Cucurbita) Stem TS	\$7.95
SER2080014	Slide – Pumpkin (Cucurbita) TS	\$7.95
SER2080207	Slide – Pumpkin Cucurbita Stem T.S. & L.S.	\$11.95
SER2080715	Slide – Pus Smear	\$7.95
SER2080869	Slide – Pus Smear Bacteria and Leucocytes	\$7.95
SER2080381	Slide – Radula Radula of Helix Whole Mount	\$9.95
SER2080195	Slide – Ranunculus (Buttercup) TS Stem	\$7.95
SER2080145	Slide – Ranunculus Root TS	\$7.95
SER2080146	Slide – Ranunculus Young and Old Root TS	\$7.95
SER2080763	Slide – Rectum TS Many Goblet Cells	\$9.95
SER2080276	Slide – Resin Ducts	\$9.95
SER2080858	Slide – Retina Entrance of Optic Nerve	\$7.95
SER2080857	Slide – Retina TS Choroid & Sciera	\$7.95
SER2080046	Slide – Rhizopus Nigricans Sporangia	\$9.95
SER2080047	Slide – Rhizopus Nigricans Zygosporangium	\$7.95
SER1197593	Slide – Root Dicot & Monocot	\$7.95
SER2080152	Slide – Root Hairs	\$7.95
SER2080153	Slide – Root Nodules	\$9.95
SER2080051	Slide – Saccharomyces	\$7.95
SER1197419	Slide – Saccharomyces (Yeast) Budding E.	\$7.95
SER2080226	Slide – Sarracenia TS Leaf with Glands	\$7.95
SER2080347	Slide – Schistosoma Whole Mount Female	\$7.95
SER2080346	Slide – Schistosoma Whole Mount Male	\$34.95
SER2080348	Slide – Schistosoma Whole Mount Pair in Copula	\$59.95
SER2080282	Slide – Sclerenchyma	\$9.95
SER2080283	Slide – Sclereids	\$9.95
SER2080382	Slide – Section Mid Body	\$9.95
SER2080237	Slide – Sedum Epidermis Shows Stomate	\$9.95
SER2080677	Slide – Simple Columnar Epithelium Inte	\$7.95
SER2080678	Slide – Simple Columnar Epithelium Kidney	\$9.50
SER2080811	Slide – Skin Bird	\$7.95
SER1197306	Slide – Skin Developing Hair VS	\$7.95
SER2080808	Slide – Skin Fish	\$7.95

## Microscope Slides

SER2080809	Slide – Skin Fish	\$7.95
SER1197305	Slide – Skin Human Pigmented VS	\$7.95
SER1197304	Slide – Skin Human Plantar VS	\$7.95
SER2080807	Slide – Skin Mammalian	\$7.95
SER2080042	Slide – Skin Primate Hairy Scalp	\$7.95
SER2080043	Slide – Skin Primate Hairy Shoulders	\$9.95
SER2080812	Slide – Skin Shark	\$7.95
SER2080810	Slide – Skin Snake	\$7.95
SER1197307	Slide – Skin Sweat Glands VS	\$7.95
SER1197303	Slide – Skin VS Insertion/Sebaceous	\$7.95
SER2080758	Slide – Small Intestine TS Showing Villi TS	\$7.95
SER2080721	Slide – Smooth Muscle (Nonstriated) TS & LS	\$7.95
SER2080722	Slide – Smooth Muscle (Nonstriated) WM	\$7.95
SER2080197	Slide – Solanum TS Tuber	\$9.95
SER2080055	Slide – Sole of Foot Primate	\$7.95
SER2080635	Slide – Spermatogenesis	\$7.95
SER2080788	Slide – Spermatozoa Mammalian	\$7.95
SER2080790	Slide – Spermatozoa Human	\$7.95
SER2080085	Slide – Sphagnum	\$7.95
SER2080086	Slide – Sphagnum Section Through Sporophyte	\$9.95
SER2080729	Slide – Spinal Cord	\$7.95
SER1197267	Slide – Spinal Cord Human Lumbar TS	\$7.95
SER2080730	Slide – Spinal Cord with Ganglion	\$9.95
SER1197396	Slide – Spirogyra Conjugat. & Zygospores	\$7.95
SER2080016	Slide – Spirogyra Vegetative Filaments	\$7.95
SER2080015	Slide – Spirogyra Scalariform Conjunction	\$7.95
SER2080834	Slide – Spleen	\$7.95
SER2080699	Slide – Spongy Bone TS Decalcified St.	\$14.95
SER2080867	Slide – Staphylococcus (Cocci Staphylococcus)	\$7.95
SER2080526	Slide – Starfish Embryology Young Starfish	\$19.95
SER2080527	Slide – Starfish TS Through Arm	\$9.95
SER2080095	Slide – Stem Equisetum	\$7.95
SER1197536	Slide – Stems Dicot. & Monocot. TS	\$7.95
SER1197569	Slide – Stigma with Pollen Tube	\$7.95
SER2080754	Slide – Stomach Cardiac TS	\$9.95
SER2080753	Slide – Stomach Duodenal Junction	\$9.95
SER2080755	Slide – Stomach Fundic TS	\$9.95
SER2080756	Slide – Stomach Pyloric TS	\$9.95
SER2080681	Slide – Stratified Cilated Col. Epithelium	\$9.50
SER1197369	Slide – Streptococcus Lactis	\$7.95

SER2080720	Slide – Striated Muscle	\$7.95
SER2080840	Slide – Sublingual Gland	\$9.95
SER2080839	Slide – Submandibular Gland	\$9.95
SER2080357	Slide – Taenia Pisiform. of Scolex Immature	\$59.95
SER2080359	Slide – Taenia Pisiformis Cystercercus	\$44.95
SER1197092	Slide – Tapeworm Mature wm	\$19.95
SER2080794	Slide – Testis & Epididymus	\$9.95
SER2080793	Slide – Testis Bird	\$9.95
SER2080792	Slide – Testis Frog	\$9.95
SER2080791	Slide – Testis Mammalian for Spermatogenesis	\$7.95
SER1197348	Slide – Testis TS Human	\$7.95
SER2080845	Slide – Thymus	\$9.95
SER2080844	Slide – Thyroid	\$9.95
SER1197301	Slide – Thyroid TS	\$7.95
SER2080435	Slide – Tick Entire Specimen Whole Mount	\$14.95
SER2080203	Slide – Tilia LS Wood	\$7.95
SER2080204	Slide – Tilia Macerated Wood	\$9.95
SER2080202	Slide – Tilia TS Young & Old Wood	\$11.95
SER2080198	Slide – Tilia TS Young Stem	\$9.95
SER2080297	Slide – Tilia Wood	\$9.95
SER1197319	Slide – Tongue Human TS	\$7.95
SER2080750	Slide – Tongue LS for General Structure	\$9.95
SER2080773	Slide – Trachea	\$9.95
SER2080138	Slide – Tradescantia Root Tip for Mitosis	\$7.95
SER2080217	Slide – Tradescantia Epidermis Showing	\$7.95
SER2080372	Slide – Trichinella Spiralis Muscle Larvae	\$9.95
SER2080284	Slide – Trichomes Whole Mount of Leaf	\$11.95
SER2080136	Slide – Triticum (Wheat) T.S. Root	\$9.95
SER2080267	Slide – Typical Plant Cell Onion	\$9.95
SER1197386	Slide – Ulothrix E	\$7.95
SER2080802	Slide – Ureter TS	\$9.50
SER2080801	Slide – Ureter LS	\$9.50
SER2080783	Slide – Uterus Dioestrus	\$9.95
SER2080782	Slide – Uterus Oestrus Changes in Mucosa	\$7.95
SER2080784	Slide – Uterus Pregnant TS Embryo In Situ	\$9.95
SER2080787	Slide – Vaginal Wall Primate	\$9.50
SER2080795	Slide – Vas Deferens	\$7.95
SER2080733	Slide – VaterPacini Corpuscles Mammal Pancreas	\$9.95
SER2080825	Slide – Vein TS	\$7.95
SER2080917	Slide – Vicia Faba Root, L.S.	\$9.50

## Microscope Slides

SER2080011	Slide - Volvox Spherical Colonies	\$7.95
SER2080121	Slide - W.M. Mature Pollon Grains	\$9.95
SER2080112	Slide - W.M. of Macerated Wood	\$9.95
SER2080691	Slide - White Fibrous Connective Tissue	\$9.50
SER2080269	Slide - Wood Cells Macerated Stem	\$7.95
SER1197801	Slide - Xylem & Phloem Cucurbita Stem	\$7.95
SER2080692	Slide - Yellow Elastic Conn. Tissue	\$9.50
SER2080291	Slide - Yucca Flower Stalk	\$9.95
SER2080295	Slide - Zea Mays (Corn Stem)	\$7.95
SER2080210	Slide - Zea Mays (Corn) Leaf TS	\$7.95
SER2080134	Slide - Zea Mays (Corn) LS Root Tip	\$7.95
SER2080163	Slide - Zea Mays (Corn) Mature Stem TS	\$7.95
SER2080164	Slide - Zea Mays (Corn) Stem L.S.	\$7.95
SER2080165	Slide - Zea Mays (Corn) Stem T.S. & L.S.	\$7.95
SER2080133	Slide - Zea Mays (Corn) T.S. Prop Root	\$7.95
SER2080135	Slide - Zea Mays Corn Root Tip	\$7.95
SER1197490	Slide - Zea Root Tip LS	\$7.95

## Accessories

SER1014105	Bibulous Paper - Drying Slides - 50 Sheets	\$7.95
SER1020030	Microscope Slide Cover Glass Slips - 18x18mm	\$1.95
SER1020041	Microscope Slide Cover Glass Slips - 22x22mm	\$1.95
SER1052900	Microscope Slide Glass - Double Cavity	\$52.95
SER1052898	Microscope Slide Glass - Frosted Both Sides	\$4.95
SER1010540	Microscope Slide Plastic Case - 15 Slides	\$6.80
SER1010550	Microscope Slide Plastic Case - 5 Slides	\$3.70
SER1007016	Microscope Slide Single Cavity Pack of 50	\$29.95
SER1010661	Slide Case - 10 Slides	\$7.95
SER1013027	Slide Case - Plastic - 100 Slides	\$11.95
SER1014919	Slide Case - Plastic - 25 Slides	\$7.95
SER1013026	Slide Case - Plastic - 50 Slides	\$7.95
SER1052899	Slide Glass Frosted Both Ends & One Side	\$7.95
SER1016040	Staining Rack - For 25 Slides	\$27.95



SER2080784

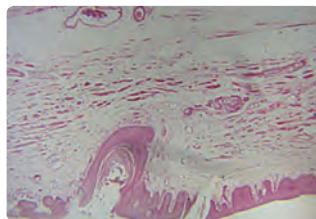

SER2080787

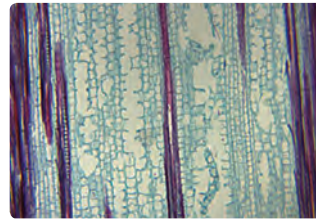

SER2080163



SER2080165

\$2,614.50  
**\$2,499<sup>95</sup>**  
 Save \$114.55



TFC57001



TFC57003



TFC57005

**Biological Strand Kit**

Premium quality biology kits helps students investigate living things and how they rely on and effect their environments. These kits can be used in conjunction with Australian Science Curriculum.

TFC57000BK	F - Y6	\$2,499.95
TFC57001	Foundation	\$225.95
TFC57003	Year 1	\$169.95
TFC57005	Year 2	\$258.95
TFC57009	Year 3	\$355.95
TFC57013	Year 4	\$489.95
TFC57017	Year 5	\$343.95
TFC57021	Year 6	\$271.95



TFC57009



TFC57013



TFC57017



TFC57020

**Our Body Books**

This collection of books shows young students all the basics about the human body, from our immune system, muscles and skeleton to our senses and skin. The 4 books can be purchased as a set, or the titles can be found individually.

RP0006K	Set of 4	\$59.95
RP6726	Our Immune System Book	\$19.95
RP6733	Our Muscles Book	\$19.95
RP6740	Our Senses Book	\$19.95
RP6764	Our Skin Book	\$19.95



\$79.80  
**\$59<sup>95</sup>**  
 Save \$19.85

**Big Books - Humans, Animals and Plants**

Brilliantly bring nature to life with the vivid images and simple text of these award-winning early science Big Books. Each oversized book measures 33.3cm x 45.7cm, and is large enough for students to see from the back of the classroom. The books can be purchased as a set or individually.

NW0009K	Kit	\$469.95
NW3200	Is It Alive? Big Book	\$59.95
NW5776	Animals and Their Babies Big Book & TG	\$59.95
NW3567	Looking At Animal Groups Big Book & TG	\$59.95
NW2673	The Vegetable Garden Big Book	\$59.95
NW5770	Human Body Big Book & TG	\$59.95
NW4850	Busy As A Bee Big Book	\$59.95
NW5777	Butterfly is Born Big Book & TG	\$59.95
NW4772	Spinning A Web Big Book	\$59.95
NW2657	The World of Ants Big Book	\$59.95

\$539.55  
**\$469<sup>95</sup>**  
 Save \$69.60



## Biology Kits, Books & Charts



### Insects Poster

Learn with these brightly coloured pictures and listed common features between all insects. Fully laminated poster measures 49.5 x 69.5cm.

TFC59062 \$7.95

~~\$299.70~~  
**\$279.95**  
 Save \$19.75

### Human Anatomy Charts

These posters are a great teaching aid for lessons on human anatomy. The 6 charts can be purchased as a set, or the titles can be found individually. These laminated anatomical charts can be written on and wiped off with non permanent markers. Size 50 x 67 cm

- |            |   |
|------------|---|
| SER0006K   | Set of 6 \$279.95                           |
| SER1033042 | Human Heart Anatomy Laminated Chart \$49.95 |
| SER1033048 | Human Respiratory System Chart \$49.95      |
| SER1033069 | Human Kidney Chart \$49.95                  |
| SER1033049 | Human Eye Chart \$49.95                     |
| SER1033051 | Human Ear Chart \$49.95                     |
| SER1033072 | Human Liver Chart \$49.95                   |

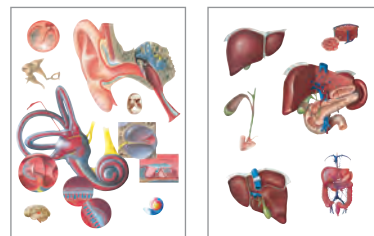
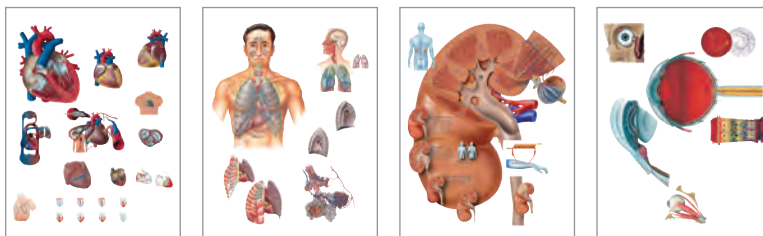

### Human Body Charts - Double-Sided

These double-sided classroom charts are a great visual tool for students to learn about our organs, skeletal system and muscle groups. Each chart is laminated and measures 69.5 x 49.5cm.

- |         |                              |
|---------|------------------------------|
| EC0100K | Set of 3 \$27.95             |
| EC0119  | Organs Systems Chart \$9.95  |
| EC0127  | Muscular System Chart \$9.95 |
| EC0135  | Skeletal System \$9.95       |

~~\$29.85~~  
**\$27.95**  
 Save \$1.90



### All About Plants Charts

These charts display vibrant and engaging artwork plus accurate content to reinforce learning. Learn all about small beginnings as a seed, process of germination, development of stems and roots, leaves, flowers and finally pollination.

- |            |  |
|------------|--|
| SERTFC003K | Set of 3 \$24.95                                   |
| TFC59059   | Plant Learning Chart \$6.95                        |
| SER1242049 | Chart - Germination - 76 x 52cm \$14.95            |
| SER1242057 | Chart - Seed Formation - Explains Formation \$9.95 |

~~\$31.85~~  
**\$24.95**  
 Save \$6.90



### Exploring Animals Chart Set

Create inviting, exciting spaces with eye-catching charts that present learning in a big and colourful way. Teach essential facts about different animals with this themed learning chart combination pack. Includes six charts: birds, reptiles, amphibians, fish, insects, and mammals, with activities and reproducibles on each chart back. Each chart is approximately 43(L) x 56(H)cm.

T38935 Set of 6 \$29.95

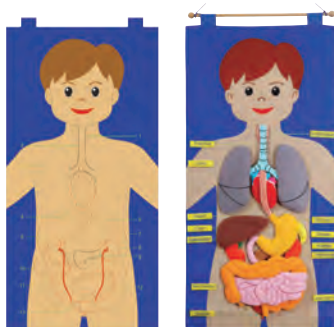

### My Body Felt Wall Chart

This felt chart has 15 attachable Velcro organs and 13 name labels, which helps students to place and label organs correctly. By linking the labels to a number, students can check if they placed the organs correctly. A great resource for curriculum topics! Size: 50 x 70cm.

KD4603 28 pieces \$79.95



### Life Cycles Charts

Stimulate development and teach essential life cycle facts with this combination pack showing life cycle information on the following: butterfly, frog, chicken and plant.

T38934 Set of 5 \$22.95





## Recycling Stations

Always wondered if the waste recycling has been done correctly and which type of waste should go in which bin? Introducing transparent recycling bins that allow you to see what's inside the bin, promoting the correct recycling of waste. The black bins are also still available, and the lids are compatible with both the transparent and black base. The transparent bins are available in 30L bins. The 30L bins measure 57.5(H) x 41(W) x 30(L)cm. The bins come with a swing lid. The black bins are available in 30L and 60L. The 60L bins measure 69(H) x 43(W) x 50(L)cm and come with a foot pedal. Each set comes in 4 colours – blue, green, yellow and red. They are also available individually.

Set of 4  
**\$166<sup>95</sup>**  
 Save \$8.65



### 30 Litre - Transparent

RGP030KT	Set of 4	<del>\$175.60</del>	\$166.95
RGP031T		Red	\$41.95
RGP032T		Yellow	\$41.95
RGP033T		Green	\$41.95
RGP034T		Blue	\$41.95

Set of 4  
**\$121<sup>95</sup>**  
 Save \$5.65



### 30 Litre - Black

RGP030K	Set of 4	<del>\$127.60</del>	\$121.95
RGP031		Red	\$29.95
RGP032		Yellow	\$29.95
RGP033		Green	\$29.95
RGP034		Blue	\$29.95



Set of 4  
**\$363<sup>95</sup>**  
 Save \$63.45



### 60 Litre - Black

RGP060K	Set of 4	<del>\$427.40</del>	\$363.95
RGP061		Red	\$98.95
RGP062		Yellow	\$98.95
RGP063		Green	\$98.95
RGP064		Blue	\$98.95



With foot pedal

## Recycling & Sustainability



### Early Recycling Game

This game lets children think about recycling from an early age by classifying 30 wooden tiles of everyday products into five recycling compartments. Suitable for a range of Australian Science Curriculum activities. Ages 6+ years  
**GD115** **\$71.95**



### Vegetable Root Viewer with Seeds

Observe vegetables growing below the soil! Perfect for simple root vegetables like carrots. The acrylic window is on an angle, which lets the roots grow against the window for a perfect view! Available in root viewer only (RGP134) or as a kit, with seeds included (carrot and beetroot). Soil not included. It measures 40(L) x 15(W) x 24(H)cm.

**RGP134** Root viewer only **\$49.95**  
**RGP134K** Root viewer & seeds **\$54.75** **\$52.95**



### Worm Farm 140 Litres Worms not included

This is an ideal system for schools to process their waste as well as teach students to care for and understand their natural environment.

**WU1024** **\$364.95**

## Learn about the environment while improving gross motor skills

### Recycling Bean Bag Game

Have a look at the new Bag Bag Recycling Game. First you need to find the matching bean bag pairs, then decide which bin to put them in: recycling, compost or rubbish. You can have fun and practise your throwing skills as you toss the bean bags in the correct bin. This game will teach children how to correctly sort their rubbish and also improve matching and gross motor skills.

**MJ030** **\$229.95**





## Worm Farm Bin & Big Book Set

Set of the worm farm (RGP0021) and Our Wriggly Worm Farm Big Book (MJ10008).

RGP0021K \$171.95

~~\$179.90~~  
**\$171.95**  
 —  
 Save \$7.95



### Worm Farm

The worm farm is a smart and clever way to convert waste into a fertile compost. The farm has 3 crates and a base crate with a tap to enable the fertile liquid to be drained as required. As children use the farm they learn about converting plant waste into compost. When assembled the farm measures 70.6(H) x 55(L) x 40(W)cm.

RGP0021 \$129.95

### Our Wriggly Worm Farm Big Book

An educational and fun way to learn about worm farms. Learn how your worm farm can reduce world pollution. Written, illustrated and printed in Australia. Big Book size 42 x 31cm. 32 pages.

MJ10008 \$49.95



### The Recycling Game – Recycle, Rubbish, Compost

First you have to find the matching pairs, then decide whether to place your items in the Recycling, Rubbish or Compost Bin. Kids will improve their memory and sorting skills while learning the difference between Recycling, Compost and Rubbish. 24 matching wooden pieces and wooden sorting bin. Wooden cards 10 x 7cm. Sorting Bin 30(L) x 10(W) x 10cm(H). Ages 3-5 years

MJ10017 \$99.95

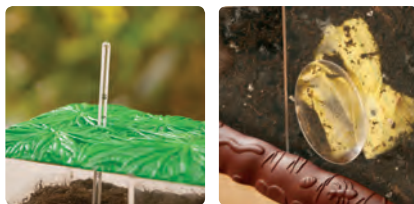

### See-Through Compost Container

Three separate, aerated compartments enable children to view the entire decomposition process clearly and make side-by-side comparisons between different materials. Included thermometers demonstrate the temperature changes during the decomposition process. Size: 33(L) x 13.3(W) x 20.3cm(H). Ages 5+ years

EN5095 \$69.95



## Geology

### Geological Changes Kit

Learn about Earth's geological changes with this curriculum kit. See what the inside of a volcano looks like, learn about fractures, faults and dislocations caused by moving Earth plates and see how you can measure the magnitude and duration of an earthquake with the seismograph. Kit includes: Volcano model, Seismograph, Fractions, Fault & Dislocation model

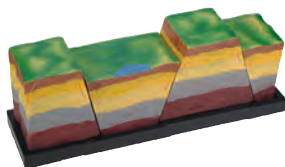
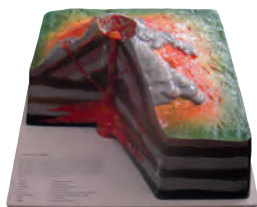

~~\$347.85~~  
**\$330.95**  
 Save \$16.90

ESC010E \$330.95

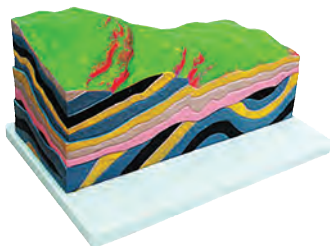

### Stratification of Earth's Crust Model

This model shows the layering that occurs in rocks formed at the earth's surface. Size: 33x23x14cm.

SER1066605 \$129.95

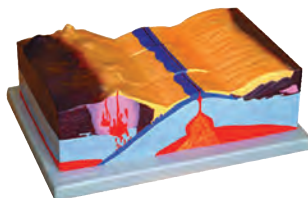

### Tectonic Plate Model

This model represents active and passive margins, ocean ridges with rift valley, benjoff plane, oceanic trenches, continental shelf and slopes. Base size: 53 x 38 x 25cm.

SER1313045 \$199.95

### Model of Earth's Internal Structure

This model shows Earth's internal structure. It shows Earth's crust, mantle, the outer centrosphere and the inner centrosphere. The model is 32cm in diameter.



NK0201 \$99.95

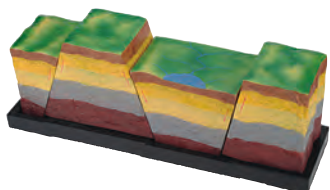

### Fractures, Faults & Dislocation Model

Learn about the most common cause of earthquakes. This colourful model shows the cross section of different structures related with fault planes and fractures. Mounted on a base. The model measures 47(L) x 14(W) x 17(H)cm.

NK1706 \$122.95



### Earth Model Cross Section

The outside of the Earth Model Cross Section shows the ocean and continents. The Earths two hemispheres separate to show the four main layers of the Earth, their temperatures and depths. Made of soft foam and easy to handle and measures 12cm(dia).

LER2437 \$37.95

### Volcano Model

This vertical section of volcano illustrates how the extremely hot magma flows from under this Earth's crust to the top. This sturdy and durable model is mounted on a base and has a numbered legend. The model measures 43(W) x 43(L) x 17(H)cm.

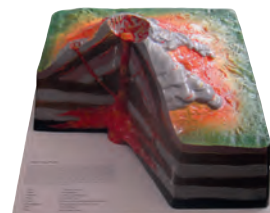

NK1711 \$149.95

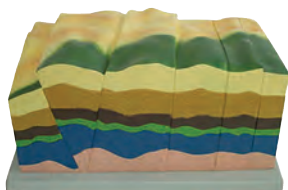

### Fault & Fractures Tectonic Stress Model

Composed of a PVC block in which joints and faults can be distinguished. Mounted on a base. Made from high quality PVC. Size: 53 x 38 x 30 cm.

SER1066601 \$229.95

### Seismograph Model

This seismograph model creates a visual representation of the shock waves generated by an earthquake. It can be used to teach both mathematical and geological concepts. The base of the model measures 30(L) x 15cm(W).The illustrated pencil is not included, any pencil of similar size can be used.

EIS0014 \$74.95

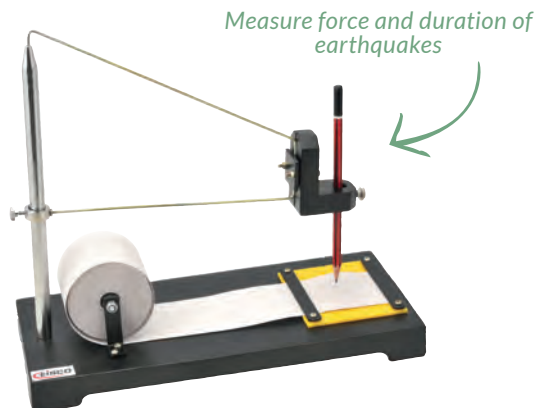

Rocks, Minerals & Fossils



\$159.80  
**\$151.95**  
 Save \$7.85

**Rocks, Minerals & Fossils Kit**

This great selection of rocks, minerals and fossils includes a fossil collection up to 70 million years old (9 fossils), 12 igneous rocks, 12 sedimentary rocks and 12 minerals.

EN5210K Set of 4 \$151.95



**Mineral Rock Set**

The kit contains 42 specimens which includes graphite, basalt, slate, schist, talc, sandstone, limestone, marble, quartz and many more.

SER1086060 Pack of 42 \$89.95



**Mineral Collection**

This set of 12 minerals is a great selection to look at minerals up close. Each specimen is hand picked for exceptional colour, texture and beauty. The set features 12 large mineral specimens, allowing you to show students the materials that combine to form rocks.

EN5207 Set of 12 \$39.95



**Igneous Rock**

This beautiful set features 12 large igneous rocks produced by hot volcanic magma action. It also includes 4-colour identification chart, self-adhesive labels, storage tray and guide packed with information.

EN5205 Set of 12 \$39.95



**Sedimentary Rock Collection**

This sedimentary rock collection features 12 large sedimentary rocks formed by layers of deposited matter over centuries.

EN5208 Set of 12 \$39.95



**Fossil Collection**

This set features 9 fossils chosen for their colour, texture, and beauty.

EN5204 Set of 9 \$39.95



**Allosaurus In Rock Fossil**

This beautiful 12inch x 6inch piece was sculpted by Scott Gale. Locked eternally in rock, this highly detailed Allosaurus skeleton is a wonderful addition to any setting.

SER1265017 \$169.95



**Large Trilobite Fossil**

Trilobites were ancient sea creatures that roamed the ocean's depths for more than 300 million years. This perfect specimen is a wonderful example of the beauty that the ancient sea offers.

SER1187024 \$139.95



**Oviraptor Egg Fossil**

In 1923 scientists gave name Oviraptor Philoceratops (Egg Eater) to a dinosaur they found lying on top a nest they thought were Protoceratops eggs. A similar egg was subsequently found containing an almost complete skeleton of an Oviraptor embryo. It is now believed that the Oviraptors were actually protecting and nurturing their own eggs rather than raiding the nest. Size of egg is 6" x 2.5"

SER1187016 \$149.95

## Weather



### Wireless Weather Station with Outdoor Sensors

This stylish unit shows external temperature/humidity, weather forecast, time logs and barometric trend log.

SER1160001

\$79.95



### Mini LCD Display Weather Station

This unit records temperature, wind chill, wind speed/direction, dew point, humidity and more.

SERXC0400

\$151.95

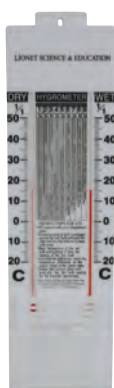

### Hanging Hygrometer Wet-Dry Bulb

This handheld device is ideal to measure the amount of water vapour in the air.

SER1028010

\$9.95



### Jumbo Display Thermometer / Hygrometer

Displays the temperature and humidity together on the one huge LCD display. It also has a min / max function (memory). Switch between C° and F°. Requires AAA battery. Temperature: -10° - 60°C (14° - 140°F). Humidity: 10 - 99% ±5% Accuracy: ±1°C ±1.8°F Size: 135(H) x 100(W) x 22(D)mm.

SER1137029

\$32.95



### Rain Gauge - Gauge Only

This is a 'tipping bucket' type rain gauge. As rain falls the water runs down through the collecting funnel into a self-emptying spoon which tips and empties each time the equivalent of 1 mm of rain has fallen. Total rainfall is measured by counting how many times the bucket tips.

SER3298

\$119.95



### Rain Gauge Pack - Gauge and Drop Counter

This device counts drops of a known constant volume as they pass an optical sensor.

SER3298PK

\$229.95



### Wind Vane & Direction on Stand

Use this product to teach students all about wind speed measurement.

SER1055044

\$37.95



**Mounted Anemometer**

Consists of 4 plastic cups (1 red) mounted on low friction bearing. Determine quantitatively by counting rotations. Sensitive 1.5Km/h.

SER1055043

\$29.95



**Anemometer with Tripod**

This anemometer provides wind speed, wind chill, temperature, barometric, and altitude information for any outdoor activity. Small enough to fit in your pocket and can be used hands-free with the included mini tripod.

SER1068001

\$99.95



**Anemometer**

Measurements in Km/h, mph, ft/min, m/s, Knots. Beaufort wind scale bar graph, wind chill, temperature, LCD backlight, auto power off, neck band, 3V lithium battery with instructions.

SER1052522

\$66.95



**Aneroid Teaching Barometer**

This is a high quality teaching barometer to demonstrate operation. The exposed aneroid shows the change in barometric pressure when you pump the attached bulb.

SER1010350

\$39.95



**Aneroid Barometer**

Dial is 103mm in diameter. This pocket size barometer is perfect to teach students about atmospheric pressure and how it changes with distance above or below sea level.

SER1129001

\$41.95



**Absolute Pressure Gas Barometer & Altimeter**

Measures the absolute pressure of the system it is connected to. Range of 0 - 700kPa making it ideal for Boyle's law. Single port absolute pressure.

SER3210

\$159.95

Set of 10  
**\$27.95**  
 Save \$1.55



**Tornado Kit**

With this simple device and two soft-drink bottles, your students can discover vortex action and its effect on air and water. A small rotation of the bottles creates a centrifugal force, which keeps liquid away from the exact centre of the tube.

DC50906

Each \$2.95

DC50906K

Set of 10 \$29.50 \$27.95



**Invicta - Upright Weather Station**

An inexpensive but complete Weather Station with all components attached to one central pole. Wind speed, wind direction, rainfall and temperature are all featured as well as the time of day observed on the Sun Dial. The Weather Station is 116cm high. Ages 6+ years

IP0826

\$79.95

## Soil & Water Testing



### Soil Moisture Meter - 300mm Stem

This soil tester measures soil conductivity and temperature.

SER1028025

\$13.95



### Soil Moisture Light & pH Meter - 300mm Stem

Soil Meter - Moisture- Ph- Light- 300mm Stem

SER1009113

\$21.95



### Metal Soil Thermometer

Thermometer Soil with knob -10 to +60C. In metal case with viewing slot and knob to push into soil with pointed end. Approximately 330mm long.

SER1028020

\$18.95



### Backpack Lab Soil Quality Testing Kit

Teachers are able to introduce students to important chemical tests for evaluating soil quality and fertility, and relate these measurements to the principles of plant metabolism.

SER1164053

\$1,199.95



### Checker Plus Soil Conductivity & Temperature Tester

This Soil Tester is a pocket tester specifically designed to directly measure soil conductivity and temperature. With a temperature sensor in the penetration probe, measurements are automatically temperature compensated.

SER1164074

\$249.95



### Ammonia Sea Water Test Kit

Ammonia test kit for sea water. Concentrations of ammonia in rivers and drinking water reservoirs indicate the presence of agriculture or urban pollution. When the concentration of ammonia is high, it can alter the smell and taste of water.

SER1164014

\$109.95



### Carbon Dioxide Water Test Kit

Carbon dioxide levels can be measured quickly and safely with the test kit. This compact, portable kit allows the user the option of field or laboratory use.

SER1164020

\$69.95





**Free Chlorine Water Test Kit**

Water Test Kit - Chlorine Free, 50 test. Free Chlorine Test Kit. Free chlorine reacts with ammonium ions and organic compounds to form chlorine compounds resulting in diminished disinfecting capabilities compared with free chlorine.

SER1164016 \$59.95



**Total Chlorine Water Test Kit**

The chlorination of water supplies and polluted waters is used mainly to destroy or deactivate disease-producing micro-organisms. It also serves to improve the quality of drinking waters, as chlorine reacts with ammonia, iron, manganese, sulphide and some organic substances.

SER1164007 \$59.95



**Dissolved Oxygen Water Test Kit**

Manganous ions react with oxygen in the presence of potassium hydroxide to form a manganese oxide precipitate. An azide is present to prevent any nitrite ions from interfering with the test. On addition of acid, manganese oxide hydroxide oxidizes the iodide to iodine.

SER1164001 \$179.95



**Ecology Combination Water Test Kit**

This kit is equipped with all the accessories and reagents to perform over 100 tests for each parameter. Electronic pH tester is also included for your convenience.

SER1164011 \$599.95



**General Water Test Kit**

Monitor the most important chemical parameters in water: alkalinity, chloride, hardness, iron, pH and sulphite with this combination test kit.

SER1164002 \$649.95



**Iron Water Test Kit**

The test kit determines the iron concentration in water by conversion of the ferrous (Fe<sup>2+</sup>) state.

SER1164018 \$59.95



**Marine Science Water Test Kit**

Aquaculture Test Kit. The kit provides users with the most important test parameters for aquaculture applications: alkalinity, carbon dioxide, dissolved oxygen, hardness, pH and salinity.

SER1164009 \$799.95



**Phosphate Water Test Kit**

Determine the phosphate concentration in samples within a 0 to 5 mg/L (ppm) range. The test kit contains enough reagents to perform approximately 50 tests. The kit also includes beaker, colour comparison cube, and reagent dropper bottles.

SER1164008 \$59.95

## Solar System

### Earth, Sun and Moon Model

This working model of the Sun, Earth and Moon demonstrates the basic relationships of rotation, night and day, seasons and phases of the Moon by moving the arm of the Moon or Earth by hand around the LED illuminated Sun. Powered by 2 'AA' batteries (included). Size: 44 x 21 x 27cm. Ages 6+ years

EIST008SM

\$153.95



### Planetarium Educational Kit

What better way to learn about our own Solar System than leaving your own marks on each of the planets? Assemble your own planetarium model, paint it and add highlights to create a glow effect.

EL8994

\$15.95



### Motorised Solar System

Explore space with this motorised solar system, complete with eight planets, the sun, star dome and Earth's moon! Set up the solar system to see Mercury, Venus, Earth, and Mars rotating slightly faster than Jupiter, Saturn, Uranus, and Neptune, just like they do in space. Turn off the lights and project a planetarium-style star show on the ceiling! Batteries required (not included).

EN5287

\$79.95



### Inflatable Solar System Set

Explore our universe with this inflatable classroom set. Teach size and distance relationships, rotation and revolution of planets, Moon and Sun with class activities and demonstrations. Includes foot pump, teacher's guide and hooks for easy hanging. Size: Sun 91cm, Moon and 9 planets from 20 to 55cm.

LER2434

11 pieces \$79.95

5+ yrs

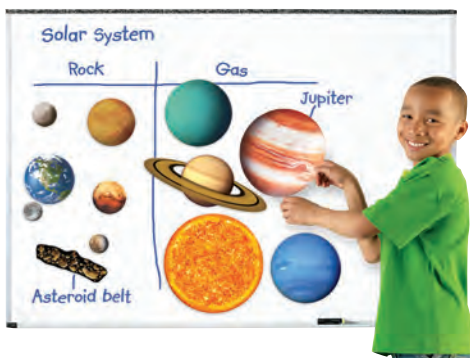

### Giant Magnetic Solar System Set

Model the full-colour, realistically detailed magnets on a whiteboard to get students' attention and teach them about space science concepts. Covers a range of cross-curriculum activities. Includes 8 planets, Pluto (dwarf planet), Earth, the moon, asteroid belt and an activity guide. The largest magnet Sun is 25.5cm in diameter.

LER6040

Set of 12 \$42.95



### Solar System Kit

Build your own solar system kit. Includes deco foam balls to make nine planets and the sun, two rings (second ring to use as a stand), 3m of aluminium wire and also an instruction sheet. Paint and decorate the planets while trying to replicate the actual planets.

SH50084

Set of 12 \$18.95



Set of 13  
**\$269<sup>95</sup>**  
 Save \$41.40

**World Globe Class Set**

With this set, students can have their own globe on their desk while the teacher demonstrates subjects like geography and the environment on the large globe. The set (FD36833) consists of 1 large globe (FD36899) and 12 small globes (FD36830). Both globes consist of 2 pieces and show up-to-date geographical maps. Sizes: large globe is 28cm in diameter, the small globe is 13cm in diameter.

FD36833 Set of 13 ~~\$311.35~~ **\$269.95**  
 FD36830-6 Small Desk Globes - Set of 6 ~~\$131.70~~ **\$113.95**  
 FD36899-4 Large Desk Globes - Set of 4 ~~\$191.80~~ **\$170.95**



**Giant World Felt Map with Bag**

A giant, cloth world map which can be hung on the wall or used on the floor for fun interactive learning about the world, the countries, cities, environment etc.

KD15104 170 x 240cm **\$359.95**



**Physical Globe with Raised Relief**

Great display of geographical characteristics with a focus on the topography of the earth.

SER1052224 32cm **\$89.95**



**Political World Globe**

This globe is perfect to teach students all the countries and geographic characteristics of earth.

SER1052223 32cm **\$52.95**



**Inflatable Labelling Globe**

68.6cm (dia) **5+** yrs

Customise this write & wipe globe to enrich geography, history, literature and social studies lessons and other cross-curriculum activities. Includes an activity guide, repair kit and display hook and string. Measures 68.6cm in diameter.

LER2438 **\$44.95**



**Physical World Globe**

This globe displays the climate, vegetation and geographical conditions.

SER1070002 32cm **\$49.95**



**Puzzle Globe**

20cm (dia) **3+** yrs

Teaching geography to little ones has never been easier, or more fun! The removable continents also include(s) animals and famous landmarks. Size: 20cm in diameter.

LER7735 20cm **\$64.95**

## Globes & Maps



Australian  
GEOGRAPHIC

### Map of Australia & Neighbours

68cm (W)  
50cm (H)

This map will help you navigate the waters of Australia's territories. It provides a fascinating insight into the political history of Australia's sea limits and our relationships with other nations in the Western Pacific. Size: 68(L) x 50(H)cm.

AG102

\$34.95



### World Map & Flags Chart

Display this chart in the classroom for reference to all the countries in the world and their flags. Gloss-laminated both sides. Write on/wipe off fully laminated. 49.5 x 69.5cm.

TFC59038

\$7.95



### World Flags

A mixed assortment of 15 international nylon flags on a 4 metre plastic string.

POS2

\$39.95



### Economy Orienteering Compass

Compass face 40mm diameter graduated in degrees cardinal points marked rotatable bezel mounted on clear base 110mm x 60mm with integral 25mm magnifying lens.

SER1135001

\$4.95



### Small Orienteering Compass

Reliable, heavy-duty compass with a snap-close lid. This compass clearly displays 360°. As a result is great for orienteering and spatial adventures around your school, measuring 4.5cm.

NK50106

\$4.95



### Magnetic Compass - 39mm Diameter

This magnetic compass is great to use in the classroom, and measures 39mm in diameter.

SER1020010

\$2.95



**Earth & Space Strand Kit – F-Y6**

This kit helps students explore the processes that result in change to the Earth's surface and the influence human activity has had over these changes.

TFC57000EK

\$2,099.95

~~\$2,259.80~~  
**\$2,099<sup>95</sup>**  
 Save **\$159.85**



**Foundation – Earth & Space Kit**

This kit gives kids understanding into daily and seasonal changes in our environment, including the weather, effect everyday life.

TFC57002

\$240.95

~~\$285.70~~  
**\$240<sup>95</sup>**  
 Save **\$44.75**



~~\$408.35~~  
**\$292<sup>95</sup>**  
 Save **\$115.40**

**Year 2 – Earth & Space Sci Kit**

This kit helps students understand earth's resources (such as water, soil, minerals) and how these are used in a variety of ways.

TFC57007

\$292.95



~~\$269.70~~  
**\$256<sup>95</sup>**  
 Save **\$12.75**

**Year 3 – Earth & Space Sci Kit**

This kit covers subjects such as earth's rotation on its axis and how it causes regular changes, including night and day and recognising the Sun as a source of light.

TFC57011

\$256.95



~~\$374.05~~  
**\$369<sup>95</sup>**  
 Save **\$4.10**

**Year 4 – Earth & Space Sci Kit**

Use this kit to investigate changes to the earth surface as a result of natural processes and human activity.

TFC57015

\$369.95



~~\$346.75~~  
**\$320<sup>95</sup>**  
 Save **\$25.80**

**Year 5 – Earth & Space Sci Kit**

Use this kit to identify and understand the planets of the solar system and how long they take to orbit the sun.

TFC57019

\$320.95



~~\$335.55~~  
**\$273<sup>95</sup>**  
 Save **\$61.60**

**Year 6 – Earth & Space Sci Kit**

This kit helps students explore the processes that result in change to the Earth's surface and the influence human activity has had over these changes.

TFC57023

\$273.95

Kits, Books & Charts



\$250.80  
**\$208<sup>95</sup>**  
 Save \$41.85



**Changes in the Sky Kit**

What happens in the sky? Learn about the planets and our solar system with this curriculum kit!

ESC009E

\$208.95

**Kit includes**

- Magnetic solar system set
- Motorised solar system
- Inflatable solar system set
- Children of the Sun panel book

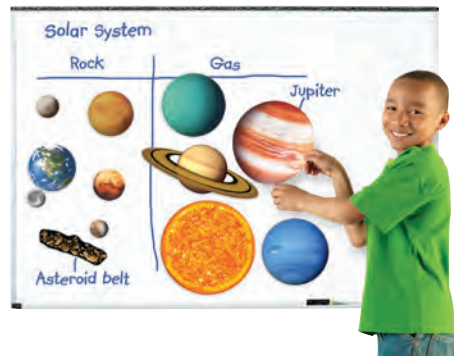

Save  
**\$11<sup>85</sup>**

**Earth & Sky Big Book Kit**

This kit consists of one of each of the following big books: The Restless Earth, From the Earth, Watching The Night Sky and Where Does The Water Go? The books provide an exciting introduction to volcanoes, earthquakes, glaciers, electricity, night sky, water and many other earth, space and environmental topics. Children also discover the different ways that we use nature's resources.

NW3262K

Set of 4 ~~\$239.80~~ \$227.95



Save  
**\$21<sup>60</sup>**

**Skywatch Solar System Book Kit**

This kit takes readers on an intergalactic journey that unravels the mysteries of the solar system. Each book measures 20 x 20cm and has 24 pages.

RP9559K

Set of 9 ~~\$179.55~~ \$157.95



**Big Books**

With these big books, students will learn interesting facts about recycling and garbage collection. What can be recycled? How does that actually work? Comes with teacher's guide. Each book measures 40.5(W) x 47.5cm(H). Ages 4+ years

NW4929

Recycle It! Big Book \$59.95

NW2651

Where Does All the Garbage Go? Big Book \$59.95



**Plants & Weather Big Book Kit**

This kit consists of one of each of the following big books: The Vegetable Garden, Green and Growing, Thinking about the Weather and Who Cares about the Weather?

NW2653K

Set of 4 ~~\$239.80~~ \$227.95

Save  
**\$11<sup>85</sup>**

Save  
**\$1985**

**Environment Big Book Pack**

This essential environment big book kit includes: How Seeds Grow, Let's Learn about Where the Rubbish Goes, How We Can Reduce Pollution, Let's Learn about Compost, Our Sustainable Farm and Recycling is fun.

MJKIT12 Set of 4 ~~\$199.80~~ \$179.95



**Find Out About Sustainability Big Books**

A selection of three non-fiction Big Books about Sustainability. Introduces children to the importance of how to help protect and look after our environment. Books measure 30(L) x 42(H)cm; 16 pages.

LMFOAPACK1 Set of 3 \$79.95  
LM42000 Growing Your Own \$29.95  
LM42001 How To Be Green Big Book \$29.95  
LM42002 Using Less Plastic Big Book \$29.95

Set of 3  
**\$79<sup>95</sup>**  
Save \$9.90

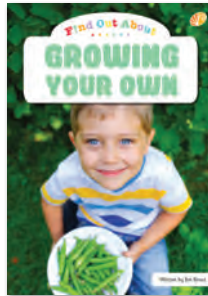

**Find Out About Waste Big Books**

A selection of three non-fiction Big Books about managing waste, which help inspire children to care for the earth. Young readers will be able to gain environmental awareness and learn about recycling and reusing. Books measure 30(L) x 42(H)cm; 16 pages

LMFOAPACK2 Set of 3 \$79.95  
LM42006 Recycling \$29.95  
LM42007 Composting \$29.95  
LM42008 What Happens To Our Rubbish \$29.95

Set of 3  
**\$79<sup>95</sup>**  
Save \$9.90



**Green Earth Discovery Books**

Teach children about the importance of looking after Earth's environment from a young age. Titles can be purchased individually or as a set of 9 (RP5393K). Size: 20.5cm square, 24 pages. Ages 4+ years

RP5393K Set of 9 books \$159.95  
RP5393 Clean and Green Energy \$19.95  
RP5409 Growing Up Green \$19.95  
RP5416 My Green Lunch \$19.95  
RP5423 Filling the Earth with Trash \$19.95  
RP5430 Trees: Earth's Lungs \$19.95  
RP9706 Cleaning Up the Earth \$19.95  
RP9713 Water World \$19.95  
RP9720 Helping Habitats \$19.95  
RP9737 What Does Green Mean? \$19.95

\$179.55  
**\$159<sup>95</sup>**  
Save \$19.60



Kits, Books & Charts



**The Restless Earth Big Book**

Here is an exciting introduction to volcanoes, earthquakes, glaciers, wind, water, and other forces that leave their marks on our planet.

NW3262

\$59.95



**Deep Space Chart**

This exciting Deep Space Chart covers the Hubble space telescope, space pioneers, crossword and a words from space game and can assist children and teachers in exploring earth and space science and systems.

CD414002

\$7.95



**Earthquakes Chart**

Learn about earthquakes – what causes them, where they occur, what to do during an earthquake and more. Resource guide on the back including activities, effects of an earthquake, interesting facts, folklore legends and vocabulary. Informative and educational. A must-have chart for the classroom. 43 x 56cm.

CD414005

\$7.95



**Solar System Chart**

This solar system chart displays the Solar System planets in order with their relative distance from the Sun. While interesting facts on our Solar System listed on the back. Write on/wipe off fully laminated and measuring 49.5 x 69.5cm.

TFC59025

\$7.95



**Rocks & Minerals Chart**

This rocks and mineral chart displays igneous, sedimentary, metamorphic rocks as well as minerals. Size is 76 x 52cm.

SER1242001

76 x 52cm \$9.95



**Dinosaur s Poster Size Cards**

Introduce your budding palaeontologists to 12 of the most interesting dinosaurs of all! Charts features vibrant and engaging artwork along with teacher-created content.

DC59053

\$44.95



Materials Investigation Kits

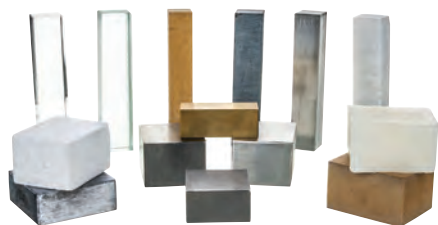

**Materials Kit – Solids**

This materials kit consists of 14 materials in the form of rectangular blocks, intended to familiarise students with the appearance, 'feel', texture, harness and density of a range of common substances.

EIS0114B Set of 14 Blocks \$107.95

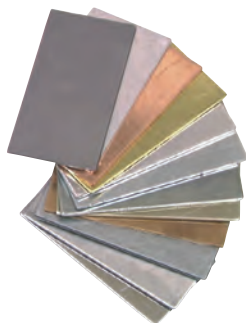

**Metal Strip Set**

Ideal for experiments to demonstrate magnetic properties and classifications of metals. The set includes soft & hard aluminium, Strips measure 50 x 25mm.

CT50147 \$39.95



**Metal Disc Set**

Ideal for experiments to demonstrate magnetic properties and classifications of metals. Includes discs of brass, copper, bronze, nickel, silver, mild steel, stainless steel, zinc and aluminium. Measures 2.5cm in diameter.

SHW51034 8pc \$16.95



**Cubes For Density Investigation**

Explore the difference in density between different materials. This cubes measure 2 x 2 x 2cm a.This is a set of 6 cubes, consisting of one of each: brass, lead, zinc, copper, aluminium, and iron.

EIS0108H Set of 6 \$34.95

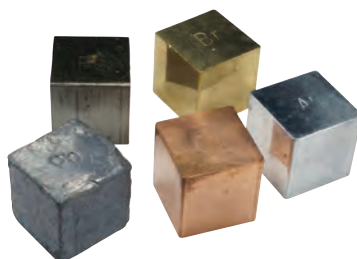

**Five Material Cube Set**

This set includes aluminium, copper, brass, iron and lead and are 25mm<sup>3</sup> in size.

SERLB1210-001 25mm \$29.95



**Density Cubes – 2.5cm<sup>3</sup>**

This set includes aluminium, copper, nylon, PVC, steel, acrylic, pine, brass, oak and poplar.

SER1055047 Set of 10 \$41.95



**Metal Cube Set - 20mm**

This set includes aluminium, steel, brass, copper and zinc.

SER1010026 Set of 7 \$45.95



**Metal Cube Set - 10mm**

This set includes aluminium, steel, brass, copper and zinc.

SER1010025 Set of 6 \$14.95



**Equal Mass Density Kit**

This set includes 7 cylinders of carbon, aluminium, brass, PVC, copper, polyethylene and steel.

SER1014083 Set of 9 \$43.95

## Molecular Models

**Atomic & Molecular Model – Large Set**

A great set for organic and inorganic molecular models. Kit includes: 8 Carbon, 15 Hydrogen, 4 Nitrogen, 6 Oxygen, 2 Sulphur, 1 Phosphorous, 6 Halogen, 8 metal (4 different types) and links

EIS00604 Set of 7 \$54.95

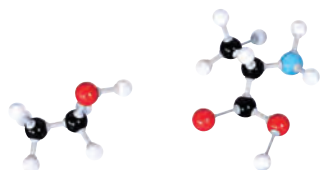
**MolecModels3D - 7 Amino Acids**

Set of 7 amino acids which includes alanine, aspartic acid, histidine, phenylalanine, methionine, serinine and valine

SER1021309 Set of 7 \$53.95

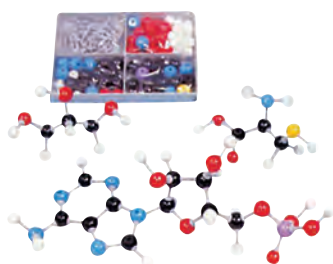
**MolecModels3D – Biochemistry Student Set**

The set contains 82 atoms and 40 links.

SER1021010 \$34.95

**MolecModels3D – Detergent**

The set contains 23 atom parts, 29 atom links and 24 Links. The set includes carbon, oxygen and hydrogen bonds.

SER1021049 \$29.95

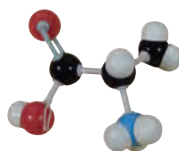
**MolecModels3D – Amino Acid Collection**

20 amino acid models per kit. Contents include atoms and links.

SER1021311 \$97.95

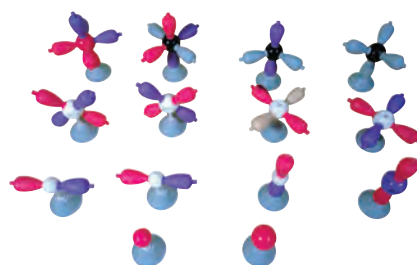
**MolecModels3D – Atomic Orbital Set**

Atomic Orbital

SER1021057 \$47.95

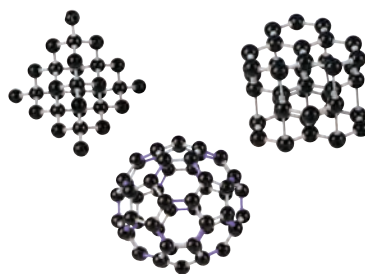
**MolecModels3D - Carbon Crystal Set**

This set is useful for teaching nanotubes which are cylinders of hexagonal carbon networks (tubes) that are modified Fullerenes derivatives and are formed either as a single wall molecule or multi walled molecules.

SER1021017 \$39.95

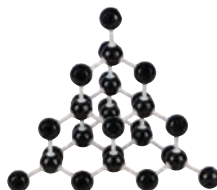
**MolecModels3D – Diamond Crystal**

The set includes 30 carbon atoms and 40 links.

SER1021015 \$34.95

**MolecModels3D – Biochemistry Teacher Set**

Contents include various atoms and links.

SER1021007 \$73.95

**MolecModels3D – Cholesterol (Biochemistry)**

This biochemistry set includes carbon and oxygen atoms. The set comes with linkages and instruction sheets.

SER1021308 \$36.95

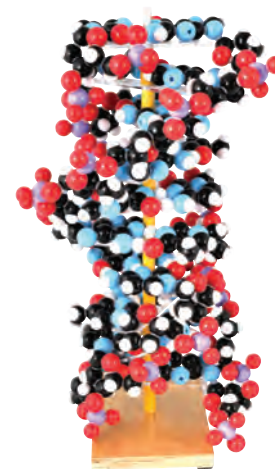
**MolecModels3D - 10 Layer DNA Set**

The set includes carbon, nitrogen, oxygen and hydrogen atoms along with links.

SER1021021 \$249.95

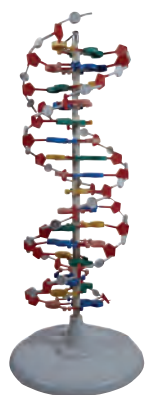

### 22 Layer Molecular DNA Model Set

This set includes colour coded bases (G,C,A And T), deoxyribose and phosphate groups, as well as a display stand.

SER1021368

\$120.95

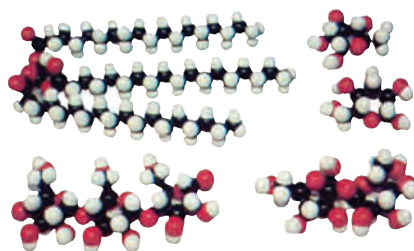

### MolecModels3D - Tripalmitin

This set includes 173 atom parts, 175 links and a tool.

SER1021043

\$61.95

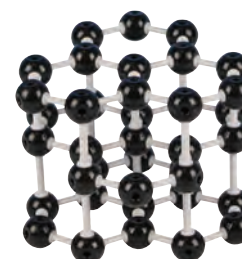

### MolecModels3D - Graphite Crystal

This set includes 45 carbon atoms and 67 links. It comes with an instruction sheet.

SER1021016

\$32.95

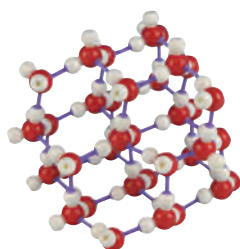

### MolecModels3D - Ice Crystal

This set includes 30 oxygen and 60 hydrogen atoms along with 100 links.

SER1021053

\$37.95



### MolecModels3D - Nylon 6.6

This set includes carbon, nitrogen, oxygen and hydrogen bonds. The set contains 90 links and an instruction sheet.

SER1021048

\$32.95



### MolecModels3D - Organic Introduction Set

This set includes hydrogen, carbon, oxygen, chlorine, nitrogen and sulphur atoms. The set comes with 62 links and an instruction sheet.

SER1021001

\$38.95

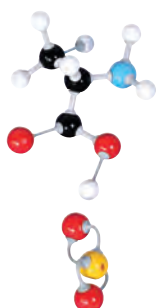

### MolecModels3D - Organic Stereo Chemistry Set

This set includes carbon, oxygen, nitrogen, chlorine, bromine, iodine and general metal atoms. The set contains 102 links and an instruction sheet.

SER1021000

\$37.95



### MolecModels3D - Organic Student Set

This set includes hydrogen, carbon, oxygen, nitrogen, sulphur, phosphorous and general metal atoms. The set contains 64 links, link remover tool and an instruction sheet.

SER1021008

\$36.95



### MolecModels3D - Organic Teacher Set

The set includes hydrogen, carbon, oxygen, chlorine, nitrogen, sulphur, phosphorous and metal atoms. The set contains 140 links, link remover tool and an instruction sheet.

SER1021003

\$39.95

## Molecular Models

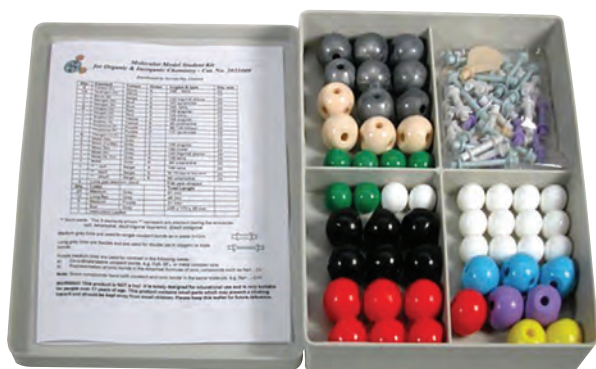

### MolecModels3D – Organic/Inorganic Student Set

The set includes hydrogen, boron, oxygen, carbon, chlorine, nitrogen, sulphur, phosphorous and general metal atoms. The set contains 37 links, link remover tool and an instruction sheet.

SER1021009

\$39.95



### MolecModels3D – Polypropylene

The set includes carbon and hydrogen bonds. The set contains 25 links, link remover tool and an instruction sheet.

SER1021045

\$24.95



### MolecModels3D – Polyvinyl Chloride

The set includes carbon and hydrogen bonds. The set contains 35 links, link remover tool and an instruction sheet.

SER1021044

\$20.95

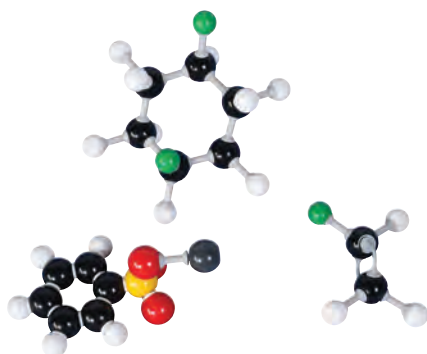

### MolecModels3D – Organic/Inorganic Teacher Set

The set includes hydrogen, carbon, oxygen, chlorine, nitrogen, sulphur, phosphorous and general metal atoms. The set contains 86 links and an instruction sheet.

SER1021004

\$48.95

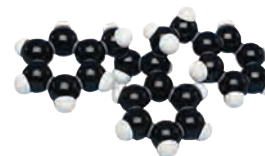

### MolecModels3D – Polystyrene Kit

The set includes carbon and hydrogen bonds. The set contains 35 links, link remover tool and an instruction sheet.

SER1021046

\$36.95



### MolecModels3D – Saturated Fat (Stearic Acid)

The set includes carbon, oxygen and hydrogen bonds. The set contains 100 links, link remover tool and an instruction sheet.

SER1021306

\$23.95



### MolecModels3D – Shapes Of Molecules

The set includes hydrogen, chlorine, fluorine, boron, chlorine, oxygen, nitrogen, carbon, phosphorous, sulphur and general metal atoms.

SER1021058

\$38.95



### MolecModels3D – Silicon Carbide

The set includes carbon, general metal atoms and 50 links. The set also comes with an instruction sheet.

SER1021302

\$38.95

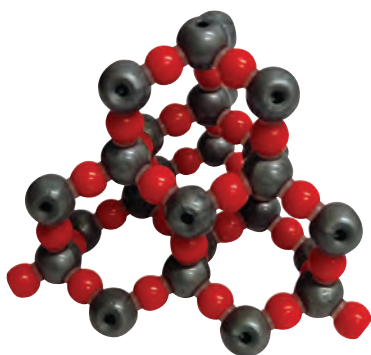

### MolecModels3D – Silicon Dioxide

The set includes oxygen, general metal atoms and 100 links. The set also comes with link remover tool and an instruction sheet.

SER1021303

\$33.95

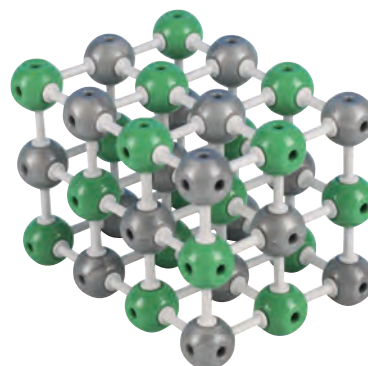

### MolecModels3D – Sodium Chloride

The set includes chlorine, general metal atoms and links. The set also comes with link remover tool and an instruction sheet.

SER1021012

\$34.95



### MolecModels3D – Stereochemistry Student Set

The set includes carbon, nitrogen, bromine, chlorine, iodine, oxygen and general metal atoms. The set contains links, link remover tool and an instruction sheet.

SER1021051

\$35.95

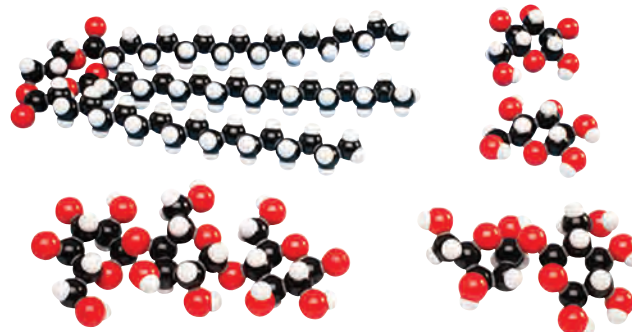

### MolecModels3D - Sucrose

The set includes carbon, oxygen and hydrogen bonds. The set contains links, link remover tool and an instruction sheet.

SER1021035

\$27.95



### MolecModels3D – Unsaturated Fat (Oleic Acid)

The set includes carbon, oxygen and hydrogen bonds. The set contains 52 links, link remover tool and an instruction sheet.

SER1021307

\$23.95

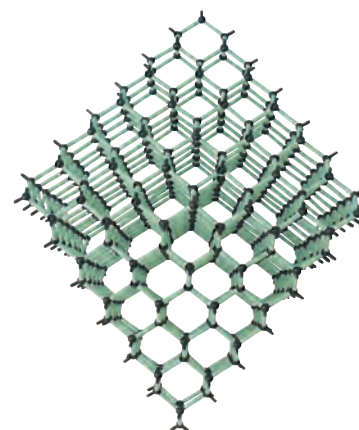

### MolecModels3D – Sucrose Kit

The set contains 450 atoms and an instruction sheet and work card to discuss the nature of the bonding, crystal structure, growth and physical properties.

SER1001023

\$97.95

## Molecular Models



### Molecular Minit Model – Organic/Inorganic

The set contains 240 atoms, 220 bonds and a booklet. Learn about molecular shape, stereochemistry, isomerism and bonding in organic and inorganic molecules and complex ions.

SER1001053

\$49.95



### Molecular Model Orbit Atom Centre Hydrogen PK/100

Students will enjoy constructing their own models with this orbit-atom pack.

SER1001071

\$17.95



### Molecular Orbit Organic/Inorganic Individual Set

This advanced set is suitable to learn about molecular shape, stereochemistry, isomerism and bonding in organic and inorganic molecules and complex ions. The set contains 240 atoms, 200 bonds and a booklet.

SER1001047

\$65.95

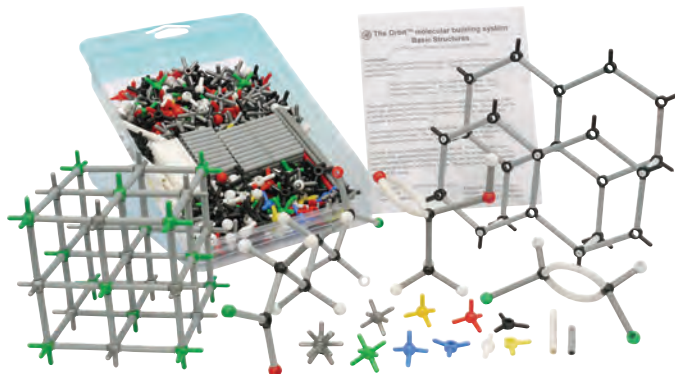

### Orbit – Basic Structures Individual Set

The set contains 290 atoms, 190 bonds and a booklet. Learn about the structures of organic molecules, inorganic materials, crystals and metals.

SER1001046

\$69.95

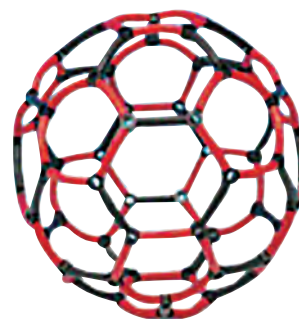

### Orbit ColourWave Model – Carbon 60 Fullerene

This kit shows the highly symmetrical structure of Carbon 60. It is composed of 12 pentagons and 20 hexagons with alternating double and single bonds illustrated by different colour tubes in the model.

SER1001231

\$19.95

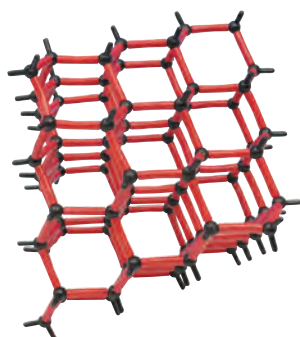

### Orbit ColourWave Model – Diamond Kit

This is a robust model containing sufficient atoms to see the relationships between structure and physical properties.

SER1001229

\$29.95

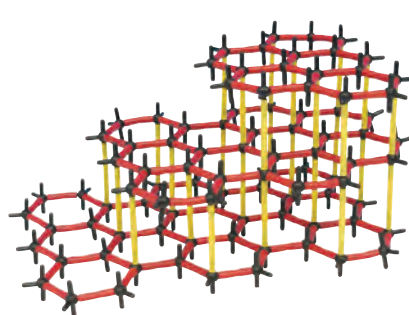

### Orbit ColourWave Model – Graphite Kit

This is an easy-to-build, low-cost kit containing sufficient atoms to see the relationships between structure and physical properties.

SER1001230

\$29.95

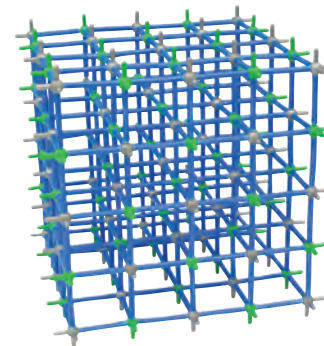

### Orbit ColourWave Model – Sodium Chloride Kit

This kit contains 125 sodium & chloride atoms. Students learn as they follow the building instructions and model description.

SER1001232

\$34.95



~~\$2,476.95~~  
**\$2,203<sup>95</sup>**  
 Save \$273.00

### Chemical Strand Kit – F-Y6

The Chemical Sciences Kit Pack helps students explore relationships between the properties of substances. These kit are designed to be used in conjunction with many of the available commercial science programs that follow the Australian Science Curriculum (ACARA).

TFC57000CK

\$2,203.95



~~\$447.70~~  
**\$379<sup>95</sup>**  
 Save \$67.75

### Year 2 – Chemical Sci Kit

Chemical Sciences Year 2 Kit helps students understand how different materials can be combined, including by mixing, for a particular purpose.

TFC57006

\$379.95



~~\$248.30~~  
**\$224<sup>95</sup>**  
 Save \$3.35

### Year 3 – Chemical Sci Kit

The Chemical Sciences Year 3 Kit helps students explore relationships between the properties of substances. These kits assist in understanding that substances can change and new substances can be created due to a number of factors.

TFC57010

\$244.95



~~\$610.75~~  
**\$499<sup>95</sup>**  
 Save \$110.80

### Year 4 – Chemical Sci Kit

Chemical Sciences Year 4 kit shows a range of physical properties of natural and processed materials. Students can learn how the properties of materials affect the management of waste or can lead to pollution.

TFC57014

\$499.95



~~\$411.65~~  
**\$406<sup>95</sup>**  
 Save \$4.70

### Year 5 – Chemical Sci Kit

This kit shows how solids, liquids and gases have different observable properties and behave in different ways. Exploring the way solids, liquids and gases change under different situations such as heating and cooling.

TFC57018

\$406.95



~~\$558.80~~  
**\$395<sup>95</sup>**  
 Save \$162.85

### Year 6 – Chemical Sci Kit

This kit helps students explore relationships between the properties of substances. This kit assists in understanding that substances can change and new substances can be created due to a number of factors.

TFC57022

\$395.95

Chemicals



**Chemistry Curriculum Kit – Reversible Changes**

Find out which changes are reversible and which ones are not, with this kit. The kit includes digital thermometers, glass beakers, bunsen burner, tripod stand, wire gauze, tubing and paper making kit.

ESC006C \$182.40 \$173.95

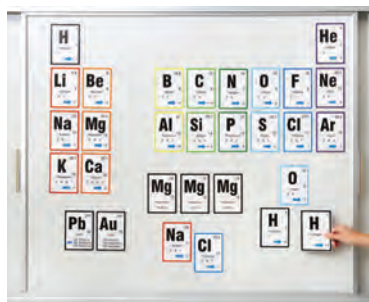

**Stick to Science – Magnetic Periodic Table**

Use this set of first 20 elements of Periodic Table to illustrate the core concepts of atomic theory. This allows students to discover the concepts of mass, electrons, valency, isotopes, atomic number and periods.

QE50200 \$49.95

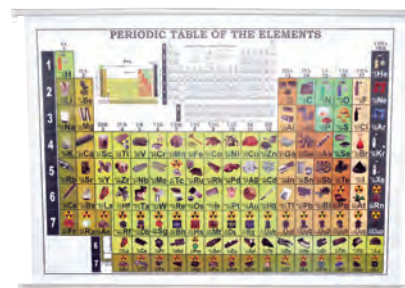

**Periodic Table of Elements Chart**

The periodic table shows the chemical symbol for each element, the atomic weight/mass, also the name and the charge. The chart shows 112 elements with pictures in multicolour. Size 75 x 100 cm.

EIS0597A \$29.95



**Laboratory Safety Chart**

A must for all science labs! This chart is full time reinforcement of safe laboratory conduct. Classroom size 75 x 100 cm.

EIS0598A \$29.95

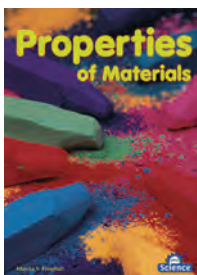

**Properties of Materials Big Book & TG**

Could you build a house out of paper? Why are forks made of metal? Students think and learn about what materials things are made of and why.

NW5816 \$59.95



**Chemistry Big Book Kit**

This chemistry big book kit consists of one of each of the following big books: Sink Or Float?, Properties of Materials, World of Matter, How Can You Tell? and Looking At Animal Groups.

NW7823K Set of 5 \$299.75 \$285.95

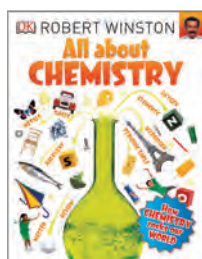

**All About Chemistry**

All About Chemistry takes an amazing look at the what, why and how of science. From the geeky Greeks to explosive elements kids can enter a world of discovery as they find out the extraordinary way our world works.

PEN6577 \$19.95



**World of Matter Big Book & TG**

Teach your students about the properties and states of matter, show them how solids, liquids and gases can transform due to different circumstances. Teach students all about the chemical changes as well.

NW7910 \$59.95

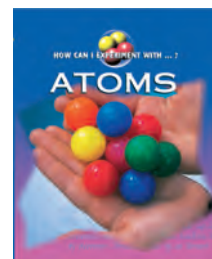

**How can I experiment with Atoms Book**

These hands-on books gives students many opportunities to experiment with atoms. Size: 20.3 x 22.8cm, each book has 32 pages. Ages 7+ years

RP0080 Set of 5 \$19.95





We carry a wide range of laboratory chemicals and chemical products, including reagents, dry chemicals, solvents, laboratory solutions and specialised chemicals. We are proud to partner with Chem-Supply PTY









Ltd, and Australian owned manufacturer and supplier of specialty chemical products.

If you don't see what you're looking for online or in our range below don't hesitate to contact us for custom orders.

## Order and Shipment of Dangerous Goods

We take safety seriously. In order to comply with state laws around Dangerous Goods documentation, when an order is placed for a dangerous good in certain classifications an End User Declaration (EUD) form must be completed, prior to shipping of the goods. The form is stored in our system for your specific order and is also passed on to local authorities to ensure items purchased are being used in a controlled environment. We are not able to ship orders until we have received signed documentation.

### Chemicals

CODE	DESCRIPTION	DANGEROUS GOODS CLASSIFICATION	PRICE
SERAA009-2.5L-P	Acetic Acid - Glacial AR - 2.5L	 - 8 - Corrosive	\$49.95
SERAA009-500M	Acetic Acid - Glacial AR - 500ml	 - 8 - Corrosive	\$23.95
SERAL025-100M	Aceto Orcein Stain - LR - 100ml	 - 8 - Corrosive	\$72.95
SERAA008-2.5L-P	Acetone - AR - 2.5L	 - 3 - Flammable Liquid	\$44.95
SERAA008-20-P	Acetone - AR - 20L	 - 3 - Flammable Liquid	\$299.95
SERAA008-500M	Acetone - AR - 500ml	 - 3 - Flammable Liquid	\$25.95
SERAL008-2.5L-P	Acetone - LR - 2.5L	 - 3 - Flammable Liquid	\$40.95
SERAT008-5L	Acetone - TG - 5L	 - 3 - Flammable Liquid	\$69.95
SERAL046-25ML	Adipoyl Chloride - LR - 25ml	 - 8 - Corrosive	\$174.95
SERAL027-100G	Agar - Powder 1000 Gel LR - 100g		\$45.95
SERAL027-500G	Agar - Powder 1000 Gel LR - 500g		\$132.95
SERAL080-25G	Alizarin Red S - LR - 25g		\$79.95
SERAL024-5G	Alizarin Yellow R - LR - 5g		\$52.95
SERAA033-500G	Aluminium Ammonium Sulphate Dodecahydrate		\$29.95
SERAL058-500G	Aluminium Chloride Anhydrous LR 98.5% - 500g	 - 8 - Corrosive	\$89.95
SERAA060-500G	Aluminium Chloride Hexahydrate - AR - 500g		\$55.95
SERAL035-500G	Aluminium Hydroxide - LR - 500g		\$62.95
SERAL041-500G	Aluminium Metal Sheet - 1.5mm - 500g		\$94.95
SERAA056-500G	Aluminium Nitrate - AR - 500g	 - 5.1 - Oxidizer	\$46.95
SERAL071-500G	Aluminium Oxide Calcined - LR - 500g		\$32.95
SERAL039-500G	Aluminium Potassium Sulfate Dodecahydrate		\$36.95

## Chemicals

CODE	DESCRIPTION	DANGEROUS GOODS CLASSIFICATION	PRICE
SERAT039-3KG	Aluminium Potassium Sulfate Dodecahydrate		\$95.95
SERAL07450500	Aluminium Potassium Sulphate - AR - 500g		\$116.95
SERAL030-100G	Aluminium Powder - LR - 100g		\$33.95
SERAL030-500G	Aluminium Powder - LR - 500g		\$139.95
SERAT038-500G	Aluminium Sulfate 14-Hydrate - TG - 500g	 - 8 - Corrosive	\$45.95
SERAA296-500G	Aluminium Sulfate 18-Hydrate - AR - 500g	 - 8 - Corrosive	\$66.95
SERAA051-500G	Ammonium Acetate - AR - 500g		\$49.95
SERAA037-500G	Ammonium Bicarbonate Hydrogen Carbonate		\$64.95
SERAA013-500G	Ammonium Carbonate - AR - 500g		\$99.95
SERAL013-500G	Ammonium Carbonate - LR - 500g		\$37.95
SERAA049-500G	Ammonium Chloride - AR - 500g		\$43.95
SERAL012-500G	Ammonium Dichromate - LR - 500g	 - 5.1 - Oxidizer	\$99.95
SERAA084-100G	Ammonium Heptamolybdate - AR - 100g		\$49.95
SERAA084-500G	Ammonium Heptamolybdate - AR - 500g		\$199.95
SERAA007-2.5L	Ammonium Hydroxide Ammonia Solution - 2.5L	 - 8 - Corrosive	\$49.95
SERAL007-500M	Ammonium Hydroxide Ammonia Solution	 - 8 - Corrosive	\$25.95
SERAA005-2.5L	Ammonium Hydroxide Ammonia Solution - 2.5L	 - 8 - Corrosive	\$52.95
SERAA005-500M	Ammonium Hydroxide Ammonia Solution - 500ml	 - 8 - Corrosive	\$29.95
SERAA078-500G	Ammonium Iron II Sulfate Ferrous - AR - 500g		\$99.95
SERAL078-500G	Ammonium Iron II Sulfate Ferrous - LR - 500g		\$59.95
SERFL041-500G	Ammonium Iron III Citrate Ferric Brown		\$109.95
SERFL024-500G	Ammonium Iron III Citrate Ferric Green		\$219.95
SERAA059-500g	Ammonium Iron III Sulfate Ferric - AR - 500g		\$61.95
SERAL072-100G	Ammonium Metavanadate - LR - 100g	 - 6.1 - Toxic Substance	\$99.95
SERAA011-500G	Ammonium Oxalate Monohydrate - AR - 500g	 - 6.1 - Toxic Substance	\$59.95
SERAL019-500G	Ammonium Persulfate - LR - 500g	 - 5.1 - Oxidizer	\$69.95
SERAM03100500	Ammonium Phosphate Di - LR - 500g		\$189.95
SERAL031-500G	Ammonium Phosphate Mono - LR - 500g		\$56.95
SERAA014-500G	Ammonium Sulfate - AR - 500g		\$55.95
SERAL016-500M	Ammonium Sulfide 10% Solution - LR - 500ml	 - 8 - Corrosive	\$129.95
SERAL014-500G	Ammonium Sulphate - LR - 500g		\$39.95
SERAA010-500G	Ammonium Thiocyanate - AR - 500g		\$49.95

CODE	DESCRIPTION	DANGEROUS GOODS CLASSIFICATION	PRICE
SERAL015-500M	Amyl Alcohol (Iso) - LR - 500m	 - 3 - Flammable Liquid	\$59.95
SERAL022-100G	Ascorbic Acid - LR - 100g		\$39.95
SERAL022-500G	Ascorbic Acid - LR - 500g		\$70.95
SERBT035-500G	Barium Carbonate - TG - 500g	 - 6.1 - Toxic Substance	\$63.95
SERBA027-500G	Barium Chloride Dihydrate - AR - 500g	 - 6.1 - Toxic Substance	\$57.95
SERBL027-500G	Barium Chloride Dihydrate - LR - 500g	 - 6.1 - Toxic Substance	\$51.95
SERBA00650500	Barium Hydroxide Octahydrate - AR - 500g	 - 8 - Corrosive	\$299.95
SERBL033-500G	Barium Hydroxide Octahydrate - LR - 500g	 - 8 - Corrosive	\$68.95
SERBA034-500G	Barium Nitrate - AR - 500g	 - 5.1 - Oxidizer	\$98.95
SERBL105-500G	Barium Sulfate - LR - 500g		\$53.95
SERBT040-500G	Barium Sulfate - TG - 500g		\$44.95
SERBL062-50G	Beef Extract - LR - 50g		\$95.95
SERBL044-500G	Beeswax White Pellets - LR - 500g		\$66.95
SERBL022-500M	Benedicts Solution - LR - 500ml		\$49.95
SERBL010-500M	Benzalkonium Chloride 10% - LR - 500ml	 - 8 - Corrosive	\$101.95
SERBA020-100G	Benzoic Acid - AR - 100g		\$24.95
SERBA020-500G	Benzoic Acid - AR - 500g		\$39.95
SERBL041-500M	Benzyl Alcohol - LR - 500ml		\$116.95
SERBA056-100G	Bismuth Nitrate - AR - 100g	 - 5.1 - Oxidizer	\$99.95
SERRE00030100	Biuret's Reagent (Proteins) - 100ml		\$155.95
SERAT285-250G	Boiling Chips Fused Alumina 3-5mm TG - 250ml		\$69.95
SERBA031-500G	Boric Acid Granular - AR - 500g		\$89.95
SERBL031-500G	Boric Acid Granular - LR - 500g		\$32.95
SERBL032-500G	Boric Acid Powder - LR - 500g		\$76.95
SER1038107	Bromine Water - LR 36% - 500ml	 - 8 - Corrosive	\$109.95
SERBL001-1G	Bromocresol Green Sodium Salt - LR - 1g		\$35.95
SERBL036-5G	Bromophenol Blue - LR - 5g		\$28.95
SERBL129-100M	Bromophenol Blue Solution - 0.04% - 100ml		\$49.95
SERBL083-500M	Bromothymol Blue - 0.1% - LR - 500ml	 - 3 - Flammable Liquid	\$141.95
SERBL083-100M	Bromothymol Blue - LR - 100ml	 - 3 - Flammable Liquid	\$28.95
SERBL053-10G	Bromothymol Blue - LR - 10g		\$49.95

## Chemicals

CODE	DESCRIPTION	DANGEROUS GOODS CLASSIFICATION	PRICE
SERBL053-5G	Bromothymol Blue - LR - 5g		\$38.95
SERBL019-500M	Buffer Solution - pH10 Blue - LR - 500ml		\$13.95
SERBL078-500M	Buffer Solution - pH10 Clear - LR - 500ml		\$32.95
SERBL107-500M	Buffer Solution - pH2 Clear - LR - 500ml		\$42.95
SERBL076-500M	Buffer Solution - pH4 Clear - LR - 500ml		\$32.95
SERBL047-500M	Buffer Solution - pH 4 Red - LR - 500ml		\$14.95
SERBL075-500M	Buffer Solution - pH6.8 Clear - LR - 500ml		\$55.95
SERBL077-500M	Buffer Solution - pH7 Clear - LR - 500ml		\$32.95
SERBL048-500M	Buffer Solution - pH7 Green - LR - 500ml		\$14.95
SERBL100-500M	Buffer Solution - pH9.2 Turquoise - 500ml		\$37.95
SERBA012-2.5L	Butyl Alcohol (Butan 1 ol) - AR - 2.5L	 - 3 - Flammable Liquid	\$169.95
SERBA012-500	Butyl Alcohol (Butan 1 ol) - AR - 500ml	 - 3 - Flammable Liquid	\$41.95
SERRP1024-G2.5L	Butyl Alcohol (Butan 1 ol) - LR - 2.5L	 - 3 - Flammable Liquid	\$141.95
SERBL013-500M	Butyl Alcohol (Butan 2 ol) - LR - 500ml	 - 3 - Flammable Liquid	\$44.95
SERBL008-100M	Butyric Acid (n-butyric) - LR - 100ml	 - 8 - Corrosive	\$63.95
SERCL016-500G	Calcium Acetate Monohydrate - LR - 500g		\$59.95
SERCT166-500G	Calcium Carbide Lumps - TG - 25-50mm - 500g	 - 4.3 - Dangerous When Wet	\$89.95
SERCA009-500G	Calcium Carbonate - AR - 500g		\$59.95
SERCL009-500G	Calcium Carbonate - LR - 500g		\$35.95
SERCT031-1KG	Calcium Carbonate (Marble Chips) - TG - 1kg		\$29.95
SERCT031-3KG	Calcium Carbonate (Marble Chips) - TG - 3kg		\$46.95
SERCL115-500G	Calcium Chloride Anhydrate - LR - 10-20 Mesh		\$45.95
SERCA033-500G	Calcium Chloride Dihydrate - AR - 500g		\$35.95
SERCA008-500G	Calcium Fluoride - AR - 500g		\$222.95
SERCA011-500G	Calcium Hydroxide - AR - 500g		\$145.95
SERCL011-500G	Ch-Calcium Hydroxide - LR - 500g		\$54.95
SERCL021-100G	Calcium Metal Dry Granular - LR - 100g	 - 4.3 - Dangerous When Wet	\$84.95
SERCL021-500G	Calcium Metal Dry Granular - LR - 500g	 - 4.3 - Dangerous When Wet	\$413.95
SERCT021-100G	Calcium Metal Dry Granular - Technical - 100g	 - 4.3 - Dangerous When Wet	\$78.95
SERCA015-500G	Calcium Nitrate Tetrahydrate - AR - 500g	 - 5.1 - Oxidizer	\$66.95
SERCL015-500G	Calcium Nitrate Tetrahydrate - LR - 500g	 - 5.1 - Oxidizer	\$63.95

CODE	DESCRIPTION	DANGEROUS GOODS CLASSIFICATION	PRICE
SERCA02600500	Calcium Oxide Granular - LR - 500g	 - 8 - Corrosive	\$79.95
SERCL625-500G	Calcium Oxide Powder - LR - 500g		\$35.95
SERCA030-500G	Calcium Phosphate (tri) - AR - 500g		\$115.95
SERCA017-500G	Calcium Sulfate Dihydrate - AR - 500g		\$119.95
SERCL017-500G	Calcium Sulfate Dihydrate - LR - 500g		\$43.95
SERCL006-500G	Carbon Activated Granular - LR - 500g		\$57.95
SERCL026-500G	Carbon Activated Powder - LR - 500g		\$50.95
SERCT043-500M	Castor Oil - Technical - 500ml		\$59.95
SERCL571-25ML	Catalase - LR - 25ml		\$65.95
SERCT096-500G	Cellulose Acetate - Technical - 500g		\$129.95
SERCL044-500G	Cetyl Alcohol - LR - 500g		\$69.95
SER1164081A	Checker Reagent - Alkalinity Fresh Water		\$49.95
SER1164077A	Checker Reagent - Ammonia Medium Range		\$41.95
SER1164085A	Checker Reagent - Chlorine Ultra High Range	 - 8 - Corrosive	\$29.95
SER1164075A	Checker Reagent - Nitrite Ultra Low Range	 - 8 - Corrosive	\$22.95
SER1164059A	Checker Reagent - Phosphate High Range	 - 9 - Miscellaneous Dangerous Goods	\$16.95
SER1164058A	Checker Reagent - Phosphate Low Range	 - 8 - Corrosive	\$22.95
SERCA038-2.5L	Chloroform - AR - 2.5L	 - 6.1 - Toxic Substance	\$85.95
SERCA038-500M	Chloroform - AR - 500ml	 - 6.1 - Toxic Substance	\$42.95
SERCL126-500G	Chromium III Chloride Hexahydrate - LR - 500g		\$137.95
SERCR01940500	Chromium (III) Nitrate Nonahydrate - LR - 500g	 - 5.1 - Oxidizer	\$169.95
SERCL039-500G	Chromium (III) Potassium Sulfate - LR - 500g		\$99.95
SERCT376-500G	Chromium (III) Sulfate - Technical - 500g	 - 8 - Corrosive	\$80.95
SERCL232-100G	Chromium Metal Powder - LR - 100g		\$119.95
SERCL013-500G	Citric Acid Anhydrous - LR - 500g		\$33.95
SERCA014-500G	Citric Acid Monohydrate - AR - 500g		\$34.95
SERCL014-500G	Citric Acid Monohydrate - LR - 500g		\$32.95
SERCL032-100M	Clove Oil - LR - 100ml		\$68.95
SERCL093-100G	Cobalt (II) Chloride Hexahydrate - LR - 100g	 - 8 - Corrosive	\$76.95
SERCL093-500G	Cobalt (II) Chloride Hexahydrate - LR - 500g	 - 8 - Corrosive	\$240.95
SERCL091-100G	Cobalt (II) Nitrate Hexahydrate - LR - 100g	 - 5.1 - Oxidizer	\$105.95

## Chemicals

CODE	DESCRIPTION	DANGEROUS GOODS CLASSIFICATION	PRICE
SERCA085-500G	Cobalt II Sulfate Heptahydrate Cobaltous		\$732.95
SERCL085-500G	Cobalt II Sulfate Heptahydrate Cobaltous		\$609.95
SERCT027-500G	Coconut Oil - Technical - 500g		\$60.95
SERCL070-25G	Congo Red Stain - LR - 25g		\$35.95
SERCL092-500G	Copper I Chloride Cuprous Chloride - LR - 500g	 - 8 - Corrosive	\$87.95
SERCL221-100G	Copper (I) Iodide (Cuprous Iodide) - LR - 100g	 - 9 - Miscellaneous Dangerous Goods	\$107.95
SERCL081-500G	Copper (I) Oxide (Cuprous) - LR - 500g	 - 9 - Miscellaneous Dangerous Goods	\$72.95
SERCL104-100G	Copper (II) Acetate Monohydrate - LR - 100g	 - 9 - Miscellaneous Dangerous Goods	\$57.95
SERCL035-100G	Copper (II) Carbonate Monohydrate - LR - 100g		\$41.95
SERCL035-500G	Copper (II) Carbonate Monohydrate - LR - 500g		\$104.95
SERCL004-500G	Copper (II) Chloride Dihydrate - LR - 500g	 - 8 - Corrosive	\$67.95
SERCA059-500G	Copper II Nitrate 2.5 Hydrate Cupric - AR - 500g	 - 5.1 - Oxidizer	\$129.95
SERCL059-500G	Copper II Nitrate Trihydrate Cupric - LR - 500g	 - 5.1 - Oxidizer	\$80.95
SERCL055-500G	Copper (II) Oxide Powder (Cupric) - LR - 500g	 - 9 - Miscellaneous Dangerous Goods	\$72.95
SERCL071-500G	Copper (II) Sulfate Anhydrous - LR - 500g	 - 9 - Miscellaneous Dangerous Goods	\$91.95
SERCA068-500G	Copper (II) Sulfate Pentahydrate - AR - 500g	 - 9 - Miscellaneous Dangerous Goods	\$55.95
SERCL068-500G	Copper (II) Sulfate Pentahydrate - LR - 500g	 - 9 - Miscellaneous Dangerous Goods	\$51.95
SERCT068-500G	Copper II Sulfate Pentahydrate Cupric - 500g	 - 9 - Miscellaneous Dangerous Goods	\$37.95
SERCL247-5G	Copper -II- Bromide Anhydrous - LR - 5g	 - 8 - Corrosive	\$79.95
SERCT068-3KG	Copper II Sulfate Pentahydrate - TG - 3kg	 - 9 - Miscellaneous Dangerous Goods	\$103.95
SERCT068-5KG	Copper II Sulfate Pentahydrate - TG - 5kg	 - 9 - Miscellaneous Dangerous Goods	\$149.95
SERCL054-500G	Copper Metal Foil - LR - 500g		\$88.95
SERCL051-500G	Copper Metal Powder - LR - 500g	 - 4.1 - Flammable Solid	\$101.95
SERCT056-500G	Copper Metal Turnings - Technical - 500g		\$98.95
SERCL207-5G	Cresol Red (o) - LR - 5g		\$89.95
SERCL067-25G	Crystal Violet - LR - 25g	 - 9 - Miscellaneous Dangerous Goods	\$35.95
SERCA019-2.5L	Cyclohexane - AR - 2.5L	 - 3 - Flammable Liquid	\$114.95
SERCA019-500M	Cyclohexane - AR - 500ml	 - 3 - Flammable Liquid	\$31.95
SERCL020-2.5L	Cyclohexanone - LR - 2.5L	 - 3 - Flammable Liquid	\$207.95
SERCL020-500M	Cyclohexanone - LR - 500ml	 - 3 - Flammable Liquid	\$56.95
SERCL073-2.5L	Cyclohexene - LR - 2.5L	 - 3 - Flammable Liquid	\$287.95

CODE	DESCRIPTION	DANGEROUS GOODS CLASSIFICATION	PRICE
SERCL073-500M	Cyclohexene - LR - 500ml	 - 3 - Flammable Liquid	\$66.95
SERQPP005-4L	Demineralized Water - 4L		\$32.95
SERDL017-100G	Diaminohexane 16 - LR - 100g	 - 8 - Corrosive	\$66.95
SERDL026-100G	Diastase (a-Amylase) - LR - 100g		\$73.95
SERP0292-500ML	Dibutyl Phthalate - 97% - 500ml	 - 9 - Miscellaneous Dangerous Goods	\$106.95
SERPL099-500G	Dichlorobenzene 14 - LR - 500g	 - 9 - Miscellaneous Dangerous Goods	\$55.95
SERML012-2.5L	Dichloromethane Methylene Chloride - LR - 2.5L	 - 6.1 - Toxic Substance	\$69.95
SERML012-500M	Dichloromethane Methylene Chloride - LR - 500ml	 - 6.1 - Toxic Substance	\$33.95
SERDL027-10G	Dichlorophenolindophenol Sodium Salt - LR - 10g		\$179.95
SERDL027-1G	Dichlorophenolindophenol Sodium Salt - LR - 1g		\$44.95
SERDL027-5G	Dichlorophenolindophenol Sodium Salt - LR - 5g		\$119.95
SEREA012-2.5L	Diethyl Ether - AR - 2.5L	 - 3 - Flammable Liquid	\$161.95
SER149452500	Diethylamine - Extra Pure - 250ml		\$109.95
SERDA013-500M	Dimethyl Sulfoxide - LR - 500ml		\$147.95
SERDA009-500M	Dimethylformamide - LR - 500ml	 - 3 - Flammable Liquid	\$43.95
SERDA041-5G	Dithizone (Diphenylthiocarbazon) - AR - 5g		\$144.95
SERDL028-100M	DPX Neutral Mounting Medium - LR - 100ml	 - 3 - Flammable Liquid	\$39.95
SEREL022-500G	EDTA Acid - LR - 500g		\$119.95
SEREA023-100G	EDTA Di Sodium Salt - AR - 100g		\$25.95
SEREA023-500G	EDTA Di Sodium Salt - AR - 500g		\$147.95
SEREL021-500G	EDTA Tetrasodium Salt - LR - 500g		\$100.95
SEREL028-25G	Eosin Yellowish Dye - LR - 25g		\$33.95
SEREL024-25G	Eriochrome Black T - LR - 25g		\$62.95
SERAL048-20L-P	Ethanol 100% Absolute Alcohol Denatured - 20L	 - 3 - Flammable Liquid	\$249.95
SERAL048-2.5L-P	Ethanol 100% Absolute Alcohol Denatured - 2.5L	 - 3 - Flammable Liquid	\$46.95
SERAL048-500M	Ethanol 100% Absolute Alcohol Denatured - 500ml	 - 3 - Flammable Liquid	\$21.95
SEREA043-2.5L	Ethanol 100% AR Absolute Alcohol Udenatured - 2.5L	 - 3 - Flammable Liquid	\$71.95
SEREA043-500M	Ethanol Absolute Alcohol- Udenatured - AR - 500ml	 - 3 - Flammable Liquid	\$44.95
SEREA011-2.5L-P	Ethyl Acetate - AR - 2.5L	 - 3 - Flammable Liquid	\$112.95
SEREA011-500M	Ethyl Acetate - AR - 500ml	 - 3 - Flammable Liquid	\$32.95
SEREA007-500M	Ethylene Glycol (Ethanediol) - AR - 500ml		\$34.95

## Chemicals

CODE	DESCRIPTION	DANGEROUS GOODS CLASSIFICATION	PRICE
SERET025-500M	Eucalyptus Oil – 80-85% – 500ml	 – 3 – Flammable Liquid	\$109.95
SER1089005	Ferrite Block Magnet – 25x11x5mm – Pack of 10		\$4.95
SERFL030-100G	Fluorescein Dye Sodium Fluorescein – LR – 100g		\$43.95
SERFL030-25G	Fluorescein Dye Sodium Fluorescein – LR – 25g		\$26.95
SERFA010-2.5L-P	Formaldehyde Solution 37/10 Formalin – AR – 2.5L	 – 3 – Flammable Liquid	\$51.95
SERFA010-500M	Formaldehyde Solution 37/10 Formalin	 – 3 – Flammable Liquid	\$31.95
SERFL004-500M	Formic Acid 85% (Methnoic) – LR – 500ml	 – 8 – Corrosive	\$42.95
SERFA009-100G	Fructose – AR – 100g		\$36.95
SERFA009-500G	Fructose – AR – 500g		\$161.95
SERFL057-25G	Fuchsin Basic Stain – LR – 25g		\$104.95
SERGL015-100G	Galactose – LR – 100g		\$137.95
SERGL005-500G	Gelatine (Gelatin) – LR – 500g		\$51.95
SERGL033-25G	Giemsa Stain Powder – LR – 25g		\$136.95
SERGA018-500G	Glucose Anhydrous (Dextrose) – AR – 500g		\$66.95
SERGL018-500G	Glucose Anhydrous (Dextrose) – LR – 500g		\$27.95
SERGA017-500G	Glucose Monohydrate (Dextrose) – AR – 500g		\$56.95
SERAC12250250	Glutamic Acid – Extra Pure – 250g		\$106.95
SERGA010-500M	Glycerine – Glycerol – AR – 500ml		\$63.95
SERGA010-2.5L-P	Glycerine (Glycerol) – AR – 2.5L		\$169.95
SERGL010-500M	Glycerine (Glycerol) – LR – 500ml		\$34.95
SERGA007-100G	Glycine – AR – 100g		\$29.95
SERGL002-500G	Graphite Powder – LR – 500g		\$108.95
SERGL009-500G	Guar Gum – LR – 500g		\$64.95
SERHL021-2.5L	Heptane (n-Heptane) – LR – 2.5L	 – 3 – Flammable Liquid	\$154.95
SERHL021-500M	Heptane (n-heptane) – LR – 500ml	 – 3 – Flammable Liquid	\$76.95
SERHL010-500M	Hexan 1 ol (n-Hexanol) – LR – 500ml	 – 3 – Flammable Liquid	\$73.95
SERHA018-2.5L	Hexane Fraction – AR – 2.5L	 – 3 – Flammable Liquid	\$174.95
SERHA018-500M	Hexane Fraction – AR – 500ml	 – 3 – Flammable Liquid	\$33.95
SERH0121-500ML	Hexene (1-Hexene) – 500ml	 – 3 – Flammable Liquid	\$139.95
SERHL014-1L	Hydrochloric Acid 0.1M – LR – 1L	 – 8 – Corrosive	\$69.95
SERHL014-2.5L-P	Hydrochloric Acid 0.1M – LR – 2.5L	 – 8 – Corrosive	\$59.95



CODE	DESCRIPTION	DANGEROUS GOODS CLASSIFICATION	PRICE
SERRP1104-P2.5L	Hydrochloric Acid 32% - AR - 2.5L	 - 8 - Corrosive	\$35.95
SERHA020-500M	Hydrochloric Acid 32% - AR - 500ml	 - 8 - Corrosive	\$24.95
SERHL020-500M	Hydrochloric Acid 32% - LR - 500ml	 - 8 - Corrosive	\$23.95
SERHT020-2.5L	Hydrochloric Acid 32% - TG - 2.5L	 - 8 - Corrosive	\$39.95
SERHT020-20L	Hydrochloric Acid 32% - TG - 20L	 - 8 - Corrosive	\$159.95
SERHT020-500M	Hydrochloric Acid 32% - TG - 500ml	 - 8 - Corrosive	\$29.95
SERHL004-2.5L-P	Hydrogen Peroxide 3% - LR - 2.5L		\$55.95
SERHL004-500M	Hydrogen Peroxide 3% - LR - 500ml		\$27.95
SERHA154-500M	Hydrogen Peroxide 30% - AR - 500ml	 - 5.1 - Oxidizer	\$81.95
SERHL001-2.5L-P	Hydrogen Peroxide 35% - LR - 2.5L	 - 5.1 - Oxidizer	\$219.95
SERHL001-500M	Hydrogen Peroxide 35% - LR - 500ml	 - 5.1 - Oxidizer	\$39.95
SERHL002-2.5L-P	Hydrogen Peroxide 6% - LR - 2.5L		\$66.95
SERHL002-500M	Hydrogen Peroxide 6% - LR - 500ml		\$34.95
SERIL053-100M	Immersion Oil Cedarwood Oil For Microscopy		\$68.95
SERIL004-25G	Indigo Carmine Redox Indicator - LR - 25g		\$63.95
SERIL030-1G	Indol 3 yl Butyric Acid 98% - LR - 1g	 - 6.1 - Toxic Substance	\$49.95
SERIL001-5G	Indole 3 Acetic Acid (1H-indol-3-yl) - LR - 5g		\$107.95
SERIA005-100G	Iodine - AR - 100g	 - 8 - Corrosive	\$46.95
SERFL017-100G	Iron II Chloride Hydrated Ferrous - LR - 100g	 - 8 - Corrosive	\$71.95
SERFL017-500G	Iron II Chloride Hydrated Ferrous - LR - 500g	 - 8 - Corrosive	\$246.95
SERFA001-500G	Iron II Sulfate Heptahydrate Ferrous - AR - 500g		\$57.95
SERFL001-500G	Iron II Sulfate Heptahydrate Ferrous - LR - 500g		\$43.95
SERIT016-500G	Iron II Sulfide Ferrous - TG Sticks - 500g		\$58.95
SERFL022-500G	Iron III Chloride Anhydrous Ferric - LR - 500g	 - 8 - Corrosive	\$53.95
SERFL023-500G	Iron III Chloride Hexahydrate Ferric - LR - 500g		\$53.95
SERFL034-500G	Iron (III) Citrate (Ferric) - LR - 500g		\$195.95
SERFA006-500G	Iron III Nitrate Nonahydrate Ferric - AR - 500g	 - 8 - Corrosive	\$69.95
SERFL012-500G	Iron (III) Oxide Red (Ferric) - LR - 500g		\$45.95
SERFL027-500G	Iron (III) Sulfate (Ferric) - LR - 500g		\$72.95
SERIT014-25KG	Iron Filings - TG - 25kg		\$99.95
SERIT014-500G	Iron Filings - TG - 500g		\$29.95



## Chemicals

CODE	DESCRIPTION	DANGEROUS GOODS CLASSIFICATION	PRICE
SERIT012-500G	Iron Oxide Magnetic - TG - 500g		\$67.95
SERIT013-500G	Iron Powder - TG - 500g		\$49.95
SERIT015-25G	Iron Wire (18swg) - TG - 25g		\$42.95
SERBL011-2.5L	iso Butanol (2 Methylpropan 1 ol) - LR - 2.5L	 - 3 - Flammable Liquid	\$209.95
SERBL011-500M	iso Butanol (2 Methylpropan 1 ol) - LR - 500ml	 - 3 - Flammable Liquid	\$39.95
SERKL000-500G	Kaolin Light - LR - 500g		\$60.95
SERCL597-5L	Laboratory Detergent - Chem-Det - LR - 5L		\$106.95
SERCL597-500ML	Laboratory Detergent Chem-Det - LR - 500ml		\$15.95
SERLL008-500M	Lactic Acid 88% - LR - 500ml		\$40.95
SERLL031-500G	Lactose Monohydrate - LR - 500g		\$37.95
SERLL003-500G	Lanolin Anhydrous - LR - 500g		\$79.95
SERLT038-500M	Latex Moulding Grade - TG - 500ml		\$48.95
SERL0011-500G	Lauric Acid - LR - 500g		\$99.95
SERLL012-500G	Lead (II) Chloride - LR - 500g	 - 6.1 - Toxic Substance	\$97.95
SERLL011-100G	Lead (II) Iodide - LR - 100g	 - 6.1 - Toxic Substance	\$113.95
SERLL021-500G	Lead (II) Oxide (Monoxide) - LR - 500g	 - 6.1 - Toxic Substance	\$39.95
SERLL027-500G	Lead (IIIV) Oxide (Red) - LR - 500g	 - 5.1 - Oxidizer	\$55.95
SERLA030-500G	Lead Acetate Trihydrate - AR - 500g	 - 6.1 - Toxic Substance	\$78.95
SERLA020-500G	Lead Foil - AR - 500g	 - 9 - Miscellaneous Dangerous Goods	\$102.95
SERLT020-500G	Lead Foil - TG - 500g	 - 9 - Miscellaneous Dangerous Goods	\$85.95
SERLA019-500G	Lead Nitrate - AR - 500g	 - 5.1 - Oxidizer	\$181.95
SERLL019-500G	Lead Nitrate - LR - 500g	 - 5.1 - Oxidizer	\$77.95
SERLT018-500G	Lead Shot (95% lead) - 500g		\$39.95
SERLL047-500G	Lead Sulfate - LR - 500g	 - 6.1 - Toxic Substance	\$215.95
SERLL007-25G	Leishman's Stain - LR - 25g		\$119.95
SERLL014-100M	Leishman's Stain - Solution LR - 100ml	 - 3 - Flammable Liquid	\$59.95
SERLL107-10G	Lipase - LR - 10g		\$47.95
SERLL032-500G	Lithium Carbonate - LR - 500g		\$105.95
SERLL036-100G	Lithium Chloride Anhydrous - LR - 100g		\$47.95
SERLL036-500G	Lithium Chloride Anhydrous - LR - 500g		\$167.95
SERLA061-100	Lithium Nitrate Anhydrous - AR - 100g	 - 5.1 - Oxidizer	\$83.95

CODE	DESCRIPTION	DANGEROUS GOODS CLASSIFICATION	PRICE
SERLL026-100G	Litmus Indicator - LR - 100g		\$147.95
SERLL026-25G	Litmus Indicator - LR - 25g		\$66.95
SERLL046-5G	Luminol - LR - 5g		\$118.95
SERLT028-25G	Lycopodium Powder - TG - 25g	 - 4.1 - Flammable Solid	\$107.95
SERMA043-500G	Magnesium Carbonate Light - AR - 500g		\$51.95
SERMA029-500G	Magnesium Chloride Hexahydrate - AR - 500g		\$122.95
SERML029-500G	Magnesium Chloride Hexahydrate - LR - 500g		\$44.95
SERML010-500G	Magnesium Hydroxide - LR - 500g		\$49.95
SERML041-500G	Magnesium Nitrate Hexahydrate - LR - 500g		\$53.95
SERML035-500G	Magnesium Oxide (Heavy) - LR - 500g		\$172.95
SERMA030-500G	Magnesium Oxide (Light) - AR - 500g		\$52.95
SERML031-100G	Magnesium Powder - LR - 100g	 - 4.3 - Dangerous When Wet	\$50.95
SERML031-500G	Magnesium Powder - LR - 500g	 - 4.3 - Dangerous When Wet	\$177.95
SERMT032-25G	Magnesium Ribbon - TG - 25g	 - 4.1 - Flammable Solid	\$24.95
SERMA048-500G	Magnesium Sulfate Heptahydrate Epsom Salts		\$39.95
SERML048-500G	Magnesium Sulfate Heptahydrate Epsom Salts		\$31.95
SERML073-500G	Magnesium Sulphate - Dried - LR - 500g		\$38.95
SER1038369	Magnesium Turnings - SG - 250g	 - 4.1 - Flammable Solid	\$141.95
SERML008-100G	Malic Acid - LR - 100g		\$54.95
SER1038212	Malonic Acid - SG - 250g		\$199.95
SERML005-100G	Maltose Monohydrate - LR - 100g		\$61.95
SERMA042-500G	Manganese II Chloride Tetrahydrate - AR - 500g		\$76.95
SERMA006-500G	Manganese (II) Sulfate Monohydrate - AR - 500g	 - 9 - Miscellaneous Dangerous Goods	\$70.95
SERML017-500G	Manganese Dioxide - LR - 500g		\$49.95
SERMT017-500G	Manganese Dioxide - TG - 500g		\$38.95
SERMA009-500G	Mannitol - AR - 500g		\$60.95
SERMT056-500G	Mercury Decontaminant - TG - 500g		\$74.95
SERML075-500G	Metaphosphoric Acid - LR - 500g	 - 8 - Corrosive	\$359.95
SERMA004-2.5L-P	Methanol - AR - 2.5L	 - 3 - Flammable Liquid	\$74.95
SERMA004-500M	Methanol - AR - 500ml	 - 3 - Flammable Liquid	\$34.95
SERML004-2.5L-P	Methanol - LR - 2.5L	 - 3 - Flammable Liquid	\$37.95

## Chemicals

CODE	DESCRIPTION	DANGEROUS GOODS CLASSIFICATION	PRICE
SERMA004-20L-P	Methanol - LR - 20L	 - 3 - Flammable Liquid	\$237.95
SERML004-500M	Methanol - LR - 500ml	 - 3 - Flammable Liquid	\$19.95
SERML065-500M	Methyl Acetate - LR - 500ml	 - 3 - Flammable Liquid	\$66.95
SERML054-500G	Methyl Cellulose - LR - 500g		\$99.95
SERMA011-500M	Methyl Ethyl Ketone - AR - 500ml	 - 3 - Flammable Liquid	\$38.95
SERML052-25G	Methyl Orange - LR - 25g	 - 6.1 - Toxic Substance	\$35.95
SERML053-10G	Methyl Red - LR - 10g		\$58.95
SERML015-500M	Methyl Salicylate - LR - 500ml		\$136.95
SERML055-25G	Methyl Violet Dye - LR - 25g	 - 9 - Miscellaneous Dangerous Goods	\$61.95
SERMT007-20L	Methylated Spirits - 95% IMS HDPE Drum - 20L	 - 3 - Flammable Liquid	\$159.95
SERMT007-5L	Methylated Spirits (95%IMS) - 5L	 - 3 - Flammable Liquid	\$62.95
SERML045-25G	Methylene Blue - LR - 25g		\$34.95
SERML068-10G	Murexide - LR - 10g		\$114.95
SERBL016-2.5L	n Butyl Acetate - LR - 2.5L	 - 3 - Flammable Liquid	\$165.95
SERBL016-500M	n Butyl Acetate - LR - 500ml	 - 3 - Flammable Liquid	\$59.95
SERNL017-500G	Napthalene Flakes - LR - 500g	 - 4.1 - Flammable Solid	\$49.95
SERNL006-500G	Nickel (II) Acetate Tetrahydrate - LR - 500g	 - 9 - Miscellaneous Dangerous Goods	\$94.95
SERNL007-500G	Nickel (II) Carbonate Tetrahydrate - LR - 500g	 - 9 - Miscellaneous Dangerous Goods	\$79.95
SERNL008-500G	Nickel (II) Chloride Hexahydrate - LR - 500g	 - 6.1 - Toxic Substance	\$76.95
SER1038387	Nickel (II) Nitrate Hexahydrate - LR - 250g	 - 5.1 - Oxidizer	\$111.95
SERNL016-500G	Nickel (II) Sulfate Hexahydrate - LR - 500g	 - 9 - Miscellaneous Dangerous Goods	\$80.95
SERNL011-25G	Nickel Foil - LR - 25g		\$81.95
SERNL013-500G	Nickel Metal Pieces (20-30mm)- LR - 500g		\$128.95
SERNA021-5G	Ninhydrin - AR - 5g		\$44.95
SERNL001-500M	Nitric Acid 70% - LR - 500ml	 - 8 - Corrosive	\$26.95
SERRP1137-G2.5L	Nitric Acid 70% RCI Premium - 2.5L	 - 8 - Corrosive	\$47.95
SERNA001-500M	Nitric Acid 70% w/w - AR - 500ml	 - 8 - Corrosive	\$31.95
SERNL023-500G	Nutrient Agar - LR - 500g		\$229.95
SERNL023-100G	Nutrient Agar - LR - 70g		\$96.95
SEROL001-500M	Octan 1 ol (n-Octanol) - LR - 500ml		\$63.95
SEROL003-100M	Octane (n-Octane) - LR - 100ml	 - 3 - Flammable Liquid	\$112.95

CODE	DESCRIPTION	DANGEROUS GOODS CLASSIFICATION	PRICE
SEROL004-500M	Oleic Acid - LR - 500ml		\$38.95
SEROT000-500M	Olive Oil - TG - 500ml		\$44.95
SEROL007-500G	Oxalic Acid Dihydrate - LR - 500g	 - 8 - Corrosive	\$49.95
SERPL043-2.5L-P	Paraffin Oil Heavy 68 - LR - 2.5L		\$72.95
SERPL043-500M	Paraffin Oil Heavy 68 - LR - 500ml		\$33.95
SERPL041-500M	Paraffin Oil Light 15 - LR - 500ml		\$39.95
SERPT200-500G	Paraffin Wax Pellets - TG - 500g		\$43.95
SERPL049-500M	Pentan 1 ol (n Amyl Alcohol) - LR - 500ml	 - 3 - Flammable Liquid	\$55.95
SERPA004-2.5L	Pentane (n Pentane) - LR - 2.5L	 - 3 - Flammable Liquid	\$174.95
SERPL004-500M	Pentane (n Pentane) - LR - 500ml	 - 3 - Flammable Liquid	\$64.95
SER1038799	Pentene (1 Pentene) 97% - LR - 100ml	 - 3 - Flammable Liquid	\$42.95
SERPL082-100G	Pepsin 1:2500 - LR - 100g		\$112.95
SERPL097-100G	Peptone - LR - 100g		\$89.95
SERPL097-250G	Peptone - LR - 250g		\$115.95
SERPA421-500M	Perchloric Acid 70% - AR - 500ml	 - 5.1 - Oxidizer	\$99.95
SERPT088-500M	Petroleum Crude (Crude Oil) - TG - 500ml	 - 3 - Flammable Liquid	\$79.95
SERPL045-500G	Petroleum Jelly White - LR - 500g		\$55.95
SERPA044-2.5L	Petroleum Spirit - 40-60° - AR - 2.5L	 - 3 - Flammable Liquid	\$85.95
SERPA210-2.5L	Petroleum Spirit - 60-80° - AR - 2.5L	 - 3 - Flammable Liquid	\$102.95
SERPL058-2.5L	Petroleum Spirit - 65-90° - LR - 2.5L	 - 3 - Flammable Liquid	\$69.95
SERPL058-500M	Petroleum Spirit - 65-90°C - LR - 500ml	 - 3 - Flammable Liquid	\$34.95
SERPA110-20L	Petroleum Spirit - 80-100°C - AR - 20L	 - 3 - Flammable Liquid	\$484.95
SERPA112-500G	Phenol Crystals - AR - 500g	 - 6.1 - Toxic Substance	\$95.95
SERPL079-5G	Phenol Red - LR - 5g		\$23.95
SERPA033-100G	Phenolphthalein - AR - 100g		\$39.95
SERPA033-25G	Phenolphthalein - AR - 25g		\$26.95
SERPL101-500M	Phenolphthalein Solution 0.5% - LR - 500ml	 - 3 - Flammable Liquid	\$51.95
SERPL195-500M	2 Phenoxyethanol - LR - 500ml		\$92.95
SER1038442	Phenyl Salicylate 99% - LR - 250g		\$149.95
SERPL016-25G	Phloroglucinol Dihydrate - LR - 25g		\$84.95
SERPL000-500M	Phosphoric Acid 85% - LR - 500ml	 - 8 - Corrosive	\$35.95

## Chemicals

















CODE	DESCRIPTION	DANGEROUS GOODS CLASSIFICATION	PRICE
SERPL121-250G	Phosphorus Pentoxide - LR - 250g	 - 8 - Corrosive	\$49.95
SERCT018-3KG	Plaster of Paris - TG - 3kg		\$45.95
SERCT018-500G	Plaster of Paris - TG - 500g		\$24.95
SERPL037-10CM	Platinum Wire - LR - 10cm		\$139.95
SERPL113-500G	Polyethylene Glycol 6000 - LR - 500g		\$91.95
SERPL032-100G	Polyvinyl Alcohol - LR - 100g		\$45.95
SERPL032-500G	Polyvinyl Alcohol - LR - 500g		\$99.95
SERPT076-500M	Polyvinyl Alcohol 10% - TG - 500ml	 - 3 - Flammable Liquid	\$52.95
SERPT076-5L	Polyvinyl Alcohol 10% - TG - 5L	 - 3 - Flammable Liquid	\$140.95
SERPA014-500G	Potassium Acetate - AR - 500g		\$115.95
SERPL007-500G	Potassium Bicarbonate - LR - 500g		\$49.95
SERPA006-500G	Potassium Bromide - AR - 500g		\$49.95
SERPA021-500G	Potassium Carbonate Anhydrous - AR - 500g		\$116.95
SERPL021-500G	Potassium Carbonate Anhydrous - LR - 500g		\$31.95
SERPL055-500G	Potassium Chlorate - LR - 500g	 - 5.1 - Oxidizer	\$69.95
SERPA054-500G	Potassium Chloride - AR - 500g		\$36.95
SERPL054-500G	Potassium Chloride - LR - 500g		\$26.95
SERPL019-500G	Potassium Chromate - LR - 500g	 - 6.1 - Toxic Substance	\$92.95
SERPA042-500G	Potassium Citrate Monohydrate - AR - 500g		\$41.95
SERPL018-500G	Potassium Dichromate - LR - 500g	 - 6.1 - Toxic Substance	\$99.95
SERPA018-500G	Potassium Dichromate - AR - 500g	 - 6.1 - Toxic Substance	\$181.95
SERPA025-500G	Potassium Ferricyanide - AR - 500g		\$295.95
SERPL025-500G	Potassium Ferricyanide - LR - 500g		\$52.95
SERPL039-500G	Potassium Ferrocyanide Trihydrate - LR - 500g		\$78.95
SERPA090-500G	Potassium Fluoride - AR - 500g	 - 6.1 - Toxic Substance	\$288.95
SERPA023-100G	Potassium Hydrogen Phthalate - AR - 100g		\$39.95
SERPA023-500G	Potassium Hydrogen Phthalate - AR - 500g		\$142.95
SERPA027-500G	Potassium Hydrogen Tartrate Cream of Tartar		\$72.95
SERPL012-500G	Potassium Hydroxide Flakes - LR - 500g	 - 8 - Corrosive	\$32.95
SERPA161-500G	Potassium Hydroxide Pellet - AR - 500g	 - 8 - Corrosive	\$41.95
SERPL161-500G	Potassium Hydroxide Pellet - LR - 500g	 - 8 - Corrosive	\$33.95

CODE	DESCRIPTION	DANGEROUS GOODS CLASSIFICATION	PRICE
SERPL078-100G	Potassium Iodate - LR - 100g	 - 5.1 - Oxidizer	\$49.95
SERPA001-100G	Potassium Iodide - AR - 100g		\$95.95
SERPA001-500G	Potassium Iodide - AR - 500g		\$136.95
SERPL001-100G	Potassium Iodide - LR - 100g		\$45.95
SERPL001-500G	Potassium Iodide - LR - 500g		\$122.95
SERPA034-500G	Potassium Metabisulfite - AR - 500g		\$79.95
SERPL092-100G	Potassium Metal Pieces - LR - 100g	 - 4.3 - Dangerous When Wet	\$238.95
SERPA011-500G	Potassium Nitrate - AR - 500g	 - 5.1 - Oxidizer	\$48.95
SERPL011-500G	Potassium Nitrate - LR - 500g	 - 5.1 - Oxidizer	\$38.95
SERPA141-500G	Potassium Oxalate Monohydrate - AR - 500g		\$62.95
SERPL061-500M	Potassium Permanganate - 0.02M Solution		\$104.95
SERPA003-500G	Potassium Permanganate - AR - 500g	 - 5.1 - Oxidizer	\$79.95
SERPL003-500G	Potassium Permanganate - LR - 500g	 - 5.1 - Oxidizer	\$57.95
SERPL131-500G	Potassium Persulfate - LR - 500g	 - 5.1 - Oxidizer	\$60.95
SERPA020-500G	Potassium Phosphate Di. - AR - 500g		\$49.95
SERPA009-500G	Potassium Phosphate Mono - AR - 500g		\$102.95
SERPL009-500G	Potassium Phosphate Mono - LR - 500g		\$40.95
SERPT040-100G	Potassium Polysulfide - TG - 100g	 - 8 - Corrosive	\$79.95
SERPT040-500G	Potassium Polysulfide - TG - 500g	 - 8 - Corrosive	\$169.95
SERPA086-500G	Potassium Sodium Tartrate Tetrahydrate		\$59.95
SERPL102-500G	Potassium Sorbate - LR - 500g		\$153.95
SERPA026-500G	Potassium Sulfate - AR - 500g		\$79.95
SERPL026-500G	Potassium Sulfate - LR - 500g		\$34.95
SERPA063-500G	Potassium Thiocyanate - AR - 500g		\$79.95
SERPL120-2.5L	Propan 1 ol - LR - 2.5L	 - 3 - Flammable Liquid	\$159.95
SERPL120-500M	Propan 1 ol - LR - 500ml	 - 3 - Flammable Liquid	\$29.95
SERPA013-2.5L-P	Propan 2 ol - AR - 2.5L	 - 3 - Flammable Liquid	\$100.95
SERPL013-2.5L-P	Propan 2 ol - LR - 2.5L	 - 3 - Flammable Liquid	\$88.95
SERPL013-20L	Propan 2 ol - LR - 20L	 - 3 - Flammable Liquid	\$449.95
SERPL013-500M	Propan 2 ol - LR - 500ml	 - 3 - Flammable Liquid	\$27.95
SERPL051-500M	Propionic Acid - LR - 500ml	 - 8 - Corrosive	\$27.95

## Chemicals

CODE	DESCRIPTION	DANGEROUS GOODS CLASSIFICATION	PRICE
SERPL010-2.5L-P	Propylene Glycol - LR - 2.5L		\$220.95
SERPL010-500M	Propylene Glycol - LR - 500ml		\$53.95
SERPT114-500G	Pumice Fine Powder - TG - 500g		\$95.95
SERQL000-25G	Quinine Sulfate Dihydrate - LR - 25g		\$95.95
SERRL003-100G	Resorcinol - LR - 100g	 - 6.1 - Toxic Substance	\$89.95
SERRL005-100M	Rosewater (Triple Distilled) - LR - 100ml		\$51.95
SERSL110-25G	Safranin O - LR - 25g		\$95.95
SERSA036-500G	Salicylic Acid - AR - 500g		\$79.95
SERST056-1KG	Sand Purified - TG - 1kg		\$32.95
SERST056-5kg	Sand Purified - TG - 5kg		\$90.95
SERSL048-100M	Sebacoyl Chloride - LR - 100ml	 - 8 - Corrosive	\$219.95
SERST048-100M	Sebacoyl Chloride - TG - 100ml	 - 8 - Corrosive	\$208.95
SERST048-25M	Sebacoyl Chloride - TG - 25ml	 - 8 - Corrosive	\$85.95
SERSL248-500G	Silica Gel Blue Self Indicating 3-8mm		\$38.95
SERSL421-500G	Silica Gel Orange Self Indicating 2.5-6mm		\$50.95
SERSL043-500G	Silica Gel Self Indicating 2-5mm 4-10 Mesh		\$30.95
SERSL072-100G	Silicon Grease - LR - 100g		\$49.95
SERST054-250G	Silicon Powder - TG - 250g	 - 4.1 - Flammable Solid	\$80.95
SERSL047-25G	Silver Acetate - LR - 25g	 - 9 - Miscellaneous Dangerous Goods	\$205.95
SERSL119-25G	Silver Chloride - LR - 25g		\$223.95
SERSL050-25G	Silver Foil (0.2mm) - LR - 25g		\$308.95
SERSA087-100G	Silver Nitrate - AR - 100g	 - 5.1 - Oxidizer	\$591.95
SERSA087-25G	Silver Nitrate - AR - 25g	 - 5.1 - Oxidizer	\$120.95
SERSL087-100G	Silver Nitrate - LR - 100g	 - 5.1 - Oxidizer	\$383.95
SERSL087-25G	Silver Nitrate - LR - 25g	 - 5.1 - Oxidizer	\$117.95
SERSL143-2.5L-P	Silver Nitrate Solution - 0.1M - LR - 2.5L	 - 9 - Miscellaneous Dangerous Goods	\$317.95
SERSL143-500M	Silver Nitrate Solution - 0.1M - LR - 500ml	 - 9 - Miscellaneous Dangerous Goods Each	\$102.95
SERSL020-500G	Soda Lime Self Indicating - LR - 500g		\$40.95
SERSL005-500G	Sodium Acetate Anhydrous - LR - 500g		\$33.95
SERSA105-500G	Sodium Acetate Trihydrate - AR - 500g		\$48.95
SERSL117-100G	Sodium Alginate - LR - 100g		\$62.95



CODE	DESCRIPTION	DANGEROUS GOODS CLASSIFICATION	PRICE
SERSA189-100G	Sodium Azide - AR - 100g	 - 6.1 - Toxic Substance	\$69.95
SERSL035-500G	Sodium Benzoate - LR - 500g		\$36.95
SERSL084-500G	Sodium Bromide - LR - 500g		\$35.95
SERSA099-500G	Sodium Carbonate Anhydrous - AR - 500g		\$38.95
SERSL099-500G	Sodium Carbonate Anhydrous - LR - 500g		\$36.95
SERSL042-500G	Sodium Carbonate Decahydrate - LR - 500g		\$62.95
SER1038534	Sodium Chlorate - Pure - 500g	 - 5.1 - Oxidizer	\$229.95
SERSA046-500G	Sodium Chloride - AR - 500g		\$22.95
SERSL046-2.5K	Sodium Chloride - LR - 2.5kg		\$41.95
SERSL088-500G	Sodium Chromate Anhydrous - LR - 500g	 - 6.1 - Toxic Substance	\$94.95
SERSA034-500G	Sodium Citrate Dihydrate Tri - AR - 500g		\$37.95
SERSL086-500G	Sodium Dichromate Dihydrate - LR - 500g	 - 6.1 - Toxic Substance	\$59.95
SERSL097-500G	Sodium Fluoride - LR - 500g	 - 6.1 - Toxic Substance	\$70.95
SERSL080-500G	Sodium Gluconate - LR - 500g		\$113.95
SERSL025-500G	Sodium Hexametaphosphate - LR - 500g		\$78.95
SERSA001-500G	Sodium Hydrogen Carbonate - AR - 500g		\$29.95
SERSL001-5kg	Sodium Hydrogen Carbonate - LR - 5kg		\$222.95
SERSL010-500G	Sodium Hydrogen Sulfate Anhydrous - LR - 500g	 - 8 - Corrosive	\$37.95
SERSL023-500G	Sodium Hydrosulfite - LR - 500g	 - 4.2 - Spontaneously Combustible	\$64.95
SERSA000-500G	Sodium Hydroxide Pearl - AR - 500g	 - 8 - Corrosive	\$28.95
SERSL000-500G	Sodium Hydroxide Pearl - LR - 500g	 - 8 - Corrosive	\$26.95
SERST000-500G	Sodium Hydroxide Pearl - TG - 500g	 - 8 - Corrosive	\$22.95
SERSA178-500G	Sodium Hydroxide Pellets - AR - 500g	 - 8 - Corrosive	\$34.95
SERSA178-5Kg	Sodium Hydroxide Pellets - AR - 5kg	 - 8 - Corrosive	\$254.95
SERSL178-500G	Sodium Hydroxide Pellets - LR - 500g	 - 8 - Corrosive	\$33.95
SERSL131-2.5L-P	Sodium Hydroxide Solution - 0.1M - 2.5L		\$59.95
SERSL131-1L	Sodium Hydroxide Solution - 0.1M - 1L		\$66.95
SERSL252-2.5L-P	Sodium Hydroxide Solution - 0.5M - 2.5L	 - 8 - Corrosive	\$69.95
SERST044-500M	Sodium Hypochlorite 10-15% - 500ml	 - 8 - Corrosive	\$23.95
SERST044-5L	Sodium Hypochlorite 8-12.5% - 5L	 - 8 - Corrosive	\$53.95
SERSL185-100G	Sodium Iodate - LR - 100g	 - 5.1 - Oxidizer	\$266.95

## Chemicals

CODE	DESCRIPTION	DANGEROUS GOODS CLASSIFICATION	PRICE
SERSA073-100G	Sodium Iodide - AR - 100g		\$69.95
SERSA073-500G	Sodium Iodide - AR - 500g		\$394.95
SERSL078-500G	Sodium Lauryl Sulfate - LR - 500g		\$126.95
SERSL013-500G	Sodium Metabisulfite - LR - 500g		\$22.95
SERSL074-500G	Sodium Metal Lumps - LR - 500g	 - 4.3 - Dangerous When Wet	\$514.95
SERSL074-100G	Sodium Metal Lumps - LR - 100g	 - 4.3 - Dangerous When Wet	\$105.95
SERST014-500G	Sodium Metasilicate Pentahydrate - TG - 500g	 - 8 - Corrosive	\$24.95
SERSL400-100G	Sodium Metavanadate - LR - 100g	 - 6.1 - Toxic Substance	\$199.95
SERSA095-100G	Sodium Molybdate Dihydrate - AR - 100g		\$79.95
SERSA098-500G	Sodium Nitrate - AR - 500g	 - 5.1 - Oxidizer	\$42.95
SERSL098-500G	Sodium Nitrate - LR - 500g	 - 5.1 - Oxidizer	\$31.95
SERSL002-500G	Sodium Nitrite - LR - 500g	 - 5.1 - Oxidizer	\$60.95
SERSA128-500G	Sodium Oxalate - AR - 500g		\$96.95
SERSA111-500G	Sodium Peroxide - AR - 500g	 - 5.1 - Oxidizer	\$193.95
SERSL096-500G	Sodium Persulfate - LR - 500g	 - 5.1 - Oxidizer	\$60.95
SERSA026-500G	Sodium Phosphate Dibasic - AR - 500g		\$52.95
SERSL061-500G	Sodium Phosphate Monobasic - LR - 500g		\$39.95
SERSA012-500G	Sodium Phosphate Tri - AR - 500g		\$33.95
SERSL205-500G	Sodium Salicylate - LR - 500g		\$144.95
SERST015-2.5L-P	Sodium Silicate Solution - TG - 2.5L		\$89.95
SERST015-500M	Sodium Silicate Solution - TG - 500ml		\$51.95
SERSA007-500G	Sodium Sulfate Anhydrous - AR - 500g		\$28.95
SERSA192-500G	Sodium Sulfate Anhydrous - AR - 500g		\$36.95
SERSL066-500G	Sodium Sulfate Decahydrate - LR - 500g		\$48.95
SERSA019-500G	Sodium Sulfide Hydrated - AR - 500g	 - 8 - Corrosive	\$298.95
SERSL019-500G	Sodium Sulfide Hydrated - LR - 500g	 - 8 - Corrosive	\$92.95
SERST019-500G	Sodium Sulfide Hydrated - TG - 500g	 - 8 - Corrosive	\$116.95
SERSL011-500G	Sodium Sulfite Anhydrous - LR - 500g		\$28.95
SERSA037-500G	Sodium Tetraborate Decahydrate - AR - 500g		\$99.95
SERSL037-500G	Sodium Tetraborate Decahydrate Granular		\$34.95
SERSL038-500G	Sodium Tetraborate Decahydrate Powder		\$40.95

CODE	DESCRIPTION	DANGEROUS GOODS CLASSIFICATION	PRICE
SERSA055-500G	Sodium Thiocyanate - AR - 500g		\$98.95
SERSA018-500G	Sodium Thiosulfate Pentahydrate - AR - 500g		\$32.95
SERSL018-500G	Sodium Thiosulfate Pentahydrate - LR - 500g		\$29.95
SERSL109-500G	Sorbic Acid - LR - 500g		\$164.95
SERSL127-250G	Starch Indicator - LR - 250g		\$143.95
SERSL126-500G	Starch Potato - LR - 500g		\$42.95
SERSL083-500G	Starch Soluble - LR - 500g		\$54.95
SERSA083-500G	Starch Soluble - AR - 500g		\$149.95
SERSL049-500G	Stearic Acid - LR - 500g		\$31.95
SERSL059-500G	Strontium Carbonate - LR - 500g		\$79.95
SERSL062-500G	Strontium Chloride Hexahydrate - LR - 500g		\$66.95
SERSL063-500G	Strontium Nitrate - AR - 500g	 - 5.1 - Oxidizer	\$254.95
SERSL068-500G	Succinic Acid - LR - 500g		\$142.95
SERSA030-500G	Sucrose - AR - 500g		\$24.95
SERSL090-25G	Sudan 3 - LR - 25g		\$57.95
SERSL089-25G	Sudan 4 - LR - 25g		\$71.95
SERSL091-500G	Sulphamic Acid - LR - 500g	 - 8 - Corrosive	\$98.95
SERSL006-500G	Sulphur - LR - 500g	 - 4.1 - Flammable Solid	\$29.95
SERST053-1KG	Sulphur Roll - TG - 1kg	 - 4.1 - Flammable Solid	\$118.95
SERRP1193-G2.5L	Sulphuric Acid 95-97% - AR - 2.5L	 - 8 - Corrosive	\$59.95
SERSA008-500M	Sulphuric Acid 98% - AR - 500ml	 - 8 - Corrosive	\$35.95
SERSL008-500M	Sulphuric Acid 98% - LR - 500ml	 - 8 - Corrosive	\$32.95
SERTT043-500G	Talc Purified - TG - 500g		\$25.95
SERTL037-500G	Tannic Acid White - LR - 500g		\$231.95
SERTA010-500G	Tartaric Acid - AR - 500g		\$40.95
SERBA060-2.5L	Tert Butyl Alcohol 2 Methylpropan - 2.5L	 - 3 - Flammable Liquid	\$215.95
SERBA060-500	Tert Butyl Alcohol 2 Methylpropan - 500ml	 - 3 - Flammable Liquid	\$52.95
SERTL060-5G	Thymol Blue (Indicator) - LR - 5g		\$64.95
SERTL022-100G	Thymol Crystals - LR - 100g	 - 8 - Corrosive	\$71.95
SERSA060-100G	Tin (II) Chloride Dihydrate - AR - 100g	 - 8 - Corrosive	\$52.95
SERSA060-500G	Tin (II) Chloride Dihydrate - AR - 500g	 - 8 - Corrosive	\$233.95

## Chemicals

CODE	DESCRIPTION	DANGEROUS GOODS CLASSIFICATION	PRICE
SERSL058-100G	Tin (IV) Chloride Pentahydrate - LR - 100g	 - 8 - Corrosive	\$115.95
SERTL017-100G	Tin Metal Foil - LR - 0.1mm - 100g		\$104.95
SERTL018-100G	Tin Metal Granules - LR - 100g		\$71.95
SERTA014-2.5L	Toluene - AR - 2.5L		\$89.95
SERTL014-500M	Toluene - LR - 500ml	 - 3 - Flammable Liquid	\$34.95
SERTL026-25G	Toluidine Blue Stain - LR - 25g		\$100.95
SERTL019-500M	Triethanolamine 85% - LR - 500ml		\$43.95
SERTA034-100G	Tris(Hydroxymethyl)Methylamine - AR - 100g		\$72.95
SERTL125-500M	Triton x 100 - LR - 500ml	 - 9 - Miscellaneous Dangerous Goods	\$48.95
SERTL031-25G	Tropaeolin OO (Orange IV) - LR - 25g		\$213.95
SERTL032-5g	Trypsin - LR - 5g		\$119.95
SERUT002-10	Universal Indicator Colour Cards - 130x50mm		\$37.95
SERUL000-100M	Universal Indicator Solution - pH3 to pH11	 - 3 - Flammable Liquid	\$24.95
SERUL000-500M	Universal Indicator Solution - pH3 to pH11	 - 3 - Flammable Liquid	\$53.95
SERUA001-500G	Urea - AR - 500g		\$37.95
SERVL002-100G	Vanadium Pentoxide - LR - 100g	 - 6.1 - Toxic Substance	\$269.95
SERXA003-500M	Xylene - AR - 500ml	 - 3 - Flammable Liquid	\$37.95
SERXL005-20L	Xylenes - LR - 20L	 - 3 - Flammable Liquid	\$328.95
SERXA003-2.5L	Xylenes - AR - 2.5L	 - 3 - Flammable Liquid	\$124.95
SERYL000-500G	Yeast Powder - LR - 500g		\$37.95
SERZA001-500G	Zinc Acetate Dihydrate - AR - 500g	 - 9 - Miscellaneous Dangerous Goods	\$67.95
SERZL004-500G	Zinc Carbonate - LR - 500g		\$64.95
SERZL005-500G	Zinc Chloride Anhydrous - LR - 500g	 - 8 - Corrosive	\$42.95
SERZL007-500G	Zinc Granules - LR - 500g		\$73.95
SERZL008-500G	Zinc Nitrate Hexahydrate - LR - 500g	 - 5.1 - Oxidizer	\$75.95
SERZA009-500G	Zinc Oxide - AR - 500g	 - 9 - Miscellaneous Dangerous Goods	\$36.95
SERZL010-500G	Zinc Powder - LR - 500g	 - 9 - Miscellaneous Dangerous Goods	\$59.95
SERZT006-40G	Zinc Sheet - Strips - 0.1mm - TG - 40g		\$27.95
SERZT006-500G	Zinc Sheet - TG - 0.1mm - 500g		\$97.95
SERZA012-500G	Zinc Sulfate Heptahydrate - AR - 500g	 - 9 - Miscellaneous Dangerous Goods	\$44.95
SERZT013-500G	Zinc Sulfide - TG - 500g		\$173.95



\$413.80  
**\$399.95**  
 Save \$13.85

**Forces and Motion Mechanism Value Pack**

This kit consists of 2 'Motion and Mechanisms' sets and 2 'Forces and Simple Machines' sets. Use this kit to teach children all about force, levers, inclined planes, axles, simple machines and mechanical machine design.

GG1234-VP Set of 4 \$399.95



**STEM Force & Motion Activity Set**

Discover the science of forces and motion through scientific exploration with colourful, engaging tools and hands-on activities.

LER2822 \$62.95



Save  
**\$8.90**

**STEM Activity Kit**

Introduce and explore magnets and simple machines. Also kids will have hours of fun exploring the concept of sinking and floating.

LER2827K Set of 3 \$188.85 \$179.95



**Gyro Robots**

This kit allows children to build 6 different experimental models which includes Gyro Robot, a Gyro Compass, a Gyrorector, a Segway, a Rope Walker, a Flight Simulator and also a Balance Game.

GG7396 \$44.95

**Learning Lab - Motion & Mechanism**

Using Gigo's Learning Lab construction blocks as a foundation, kids can learn the designs of complex transport machines, and understand the movement and the function of different types of mechanical structures, including: gear racks, cams, and worm gears. It helps kids to develop the foundations of mechanical machine design. The set includes 20 lesson plans, including 16 models and 4 creative works, a student workbook, and 3D Smart Manual to view the model on your tablet in 3D. Each lesson plan consists of an introduction with theory, building instructions, the experiment, improvements and evaluation.

GG1235 20 Modules - Each set \$104.95  
 GG1235K Set of 4 \$419.80 \$398.95

Set of 4  
**\$398.95**  
 Save \$20.85



328 pieces

Forces & Motion



Cube for Density Investigation – 2cm

Each cube measures 2cm and comes without hook. They can be purchased individually or as a set of 6. Supplied with instruction manual.

EIS0108H Set of 6 \$34.95



Economy Collision Balls

This economy model demonstrates elastic collision well. Teach your students about kinetic energy and elastic collision. Size: 13.5 x 11.5 x 14cm.

EIS0349ECB \$89.95

Track & Ramp & Hall's Cars Kit

This kit allows you to test multiple variables (i.e. angle of the ramp and weight applied to the Hall's Car) at once! The kit includes 2 track & ramps (EIS0355DYTR) and 2 sets of Hall's Cars – Set of 2 (EIS0351A)

EIS0351K \$305.95

\$321.80  
**\$305<sup>95</sup>**  
 —  
 Save \$15.85

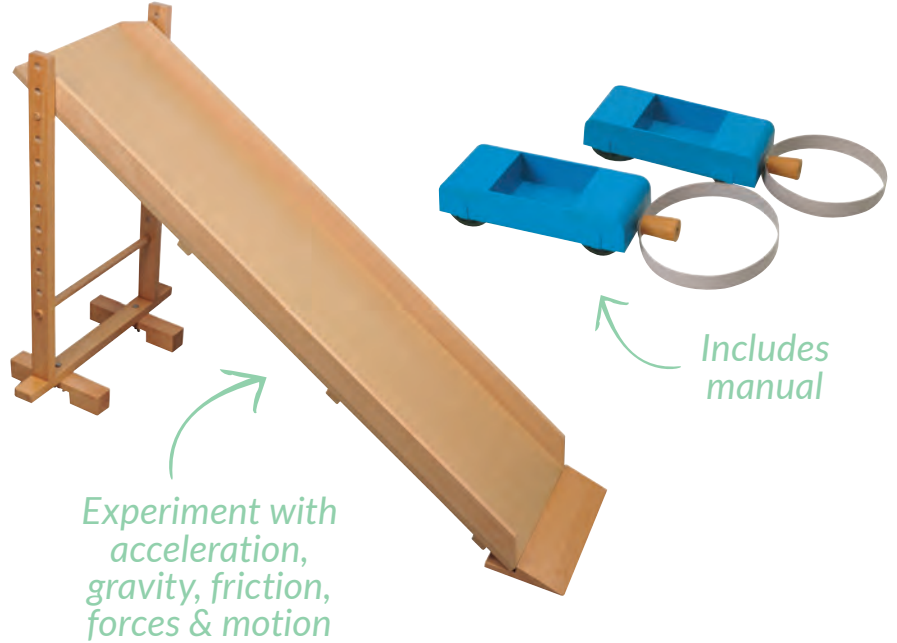

Dynamic Track, Stand & Ramp

Find out how fast an object rolls off the ramp and experiment with different weights of the objects and height of the ramp. The track is 1.2m long x 30cm wide. The stand measures 65cm high. With run-off ramp to bridge the gap between track and floor when required.

EIS0355DYTR \$119.95

Hall's Cars Experiment

This Hall's Car Pair is the most important lab essential for dynamics experiments. This car is used in conjunction with the inclined plane or ramp, pulley and weights to study the relationship between work and energy. The car has low friction wheels on oil free sleeve bearings which never need adjustment. The durable plastic moulded body has a deep well for weights and low profile.

EIS0351A Set of 2 \$40.95

TTS7018K  
**\$952<sup>95</sup>**  
 —  
 Save \$48.75

Slope Kit with Two Double-Sided Boards

This multiple surface ramp kit is a great classroom resource for science investigations on forces, motion and friction. The two double-sided ramps feature four different surfaces: plain wood, foam, carpet underlay and sandpaper. The stand enables the ramp to be adjusted to five different heights enabling pupils to change the angle of the slope. Robust and sturdy, the stand will not tip over and its compact design makes the ramp kit easy to store. Ramp sizes approx 70 x 18cm. Accessories not included.

TTS7018-K Slope, Hall's Cars & Weights Kit ~~\$221.85~~ \$210.95  
 TTS7018K Slope & Ramp Kit 4 surfaces –Set of 6 \$952.95





**Small Springs**

Springs 2.2 x 1.5cm, for demonstrating Hooke's Law, resolution of forces, kinetic energy measurement, etc. Will recover from stretch to approximately 40cm.

DC51006 Set of 100 \$61.95



**Springs**

Diameter: Between 1 and 3cm approx. Flexible length between 10-20cm. With hooks on both side.

EIS0115A Set of 6 Assorted sizes \$13.95

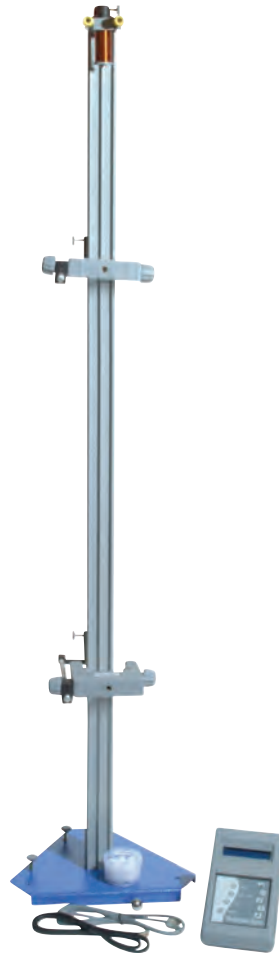

**Free Fall Model  
Advanced Gravity Experiments**

This apparatus is designed for studying acceleration by gravity. It allows the small drag from air resistance on the steel to be measured.

EIS001FF \$164.95



**Dynamic Trolley Pair - Plastic**

These carts have a single piece body. Mounted on a set of 3 low-friction nylon wheels providing a straight distance over long distances. Enables placing of additional masses. Lockable spring-loaded plunger.

EIS0351PL-N8 Pair \$89.95



**Magdeburg Hemisphere - Plastic**

Magdeburg Hemisphere features a convenient valve for easy operation and release.

EIS0171A \$21.95



**Projectile Launcher with Operating Instructions**

This projectile launcher provides accurate and repeatable trajectories and distances due to fine tune launch mechanism and minimal ball spin.

EIS0343 \$99.95



**Force Table - Economy 3-legged - No Weights**

This lightweight and accurate table is complete with four pulleys and four weight hangers.

EIS0347F \$199.95

## Simple Machines

Includes 20 lesson plans



### Forces & Simple Machines

Using Gigo's construction blocks, kids can build models of cranes and scales within the courses while they learn about the principles behind the movement of force, levers, inclined planes, axles and some other simple machines. The set includes 20 lesson plans, including 16 models and 4 creative works, a student workbook, and 3D Smart Manual to view the model on your tablet in 3D. Each lesson plan consists of an introduction with theory, building instructions, the experiment, improvements and evaluation.

GG1234 Each set \$101.95  
GG1234K Set of 4 \$407.80 \$387.95



250 pieces



Set of 4  
**\$387.95**  
Save \$19.85

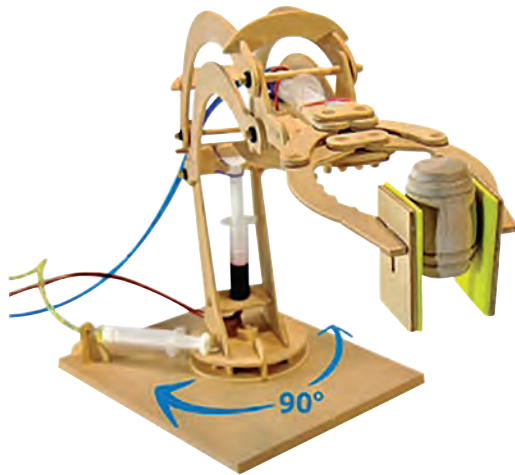

### Hydraulic Robotic Arm

This model uses a battery of independent hydraulic circuits to provide absolute control over the arm pincers: grip, lift, twist, lower and release. This set teaches the basics of hydraulics and robotics.

SN6710

\$49.95



### Hydraulic 4-in-1 Mini Machines

This set includes the four main hydraulic mini machines: the cherry picker, and excavator as well as the platform lifter and scissor lift. The cherry picker teaches the principles of linkages and includes a small platform for figurines that remains flat at any height. The excavator teaches the principles of levers and hydraulic power. The mechanism includes two hydraulic cylinders and can be adjusted to provide either digging or scooping actions.

SN6706

\$59.95

Build over 15 machines at the same time

### Hydraulic Classroom Pack

This large hydraulic classroom pack ensures that you only need scissors, glue and cardboard to get the class inventing with parts for 30 students in pairs to build over 15 machines with an average of 4 pistons per machine.

SN6717

\$299.95





## Wooden Simple Machines Class Set

These wooden simple machines are a great resource to show your students how simple machines can provide mechanical advantage and change the magnitude and direction of a force. Each model has a sturdy construction, perfect for classroom use. The models come with detailed instructions and activities.

EIS0019K

Set of 12 \$374.95

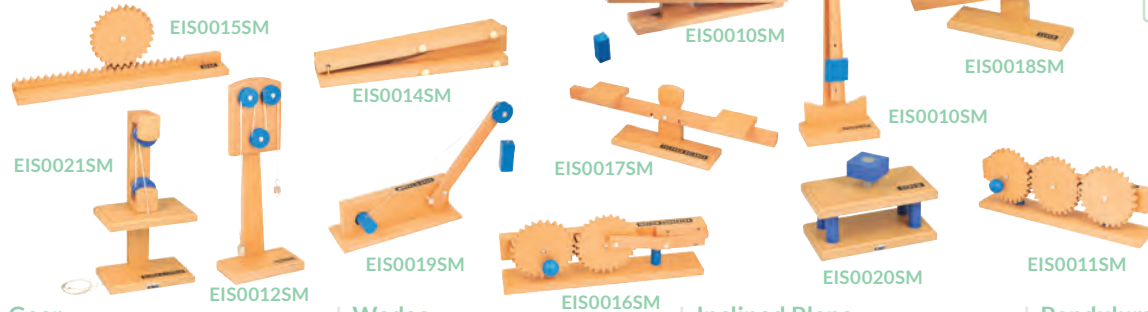

~~\$394.40~~  
**\$374<sup>95</sup>**  
 Save \$19.45



### Gear

This model can demonstrate how gears can turn rotational motion into translational motion. The base is 40 x 6cm and the model is 15.2cm tall.

EIS0015SM

\$40.95

### Wedge

This model can be used to demonstrate how a wedge can increase mechanical advantage. Size: 35 x 9.5cm base with adjustable height.

EIS0014SM

\$27.95

### Inclined Plane

With a shallow indent for adding additional mass if needed. With rubber wheels and grooves in the track of the inclined plane. Size: 42 x 8.2cm with an adjustable height.

EIS0010SM

\$28.95

### Pendulum

Study the relation between length of the pendulum and period of the bob. Size: base 8.9 x 16.5cm, 39.5cm with 30cm adjustable pendulum.

EIS0013SM

\$27.95

### Lever

Study levers and mechanical advantage both qualitatively and quantitatively. Size: base 22 x 7cm, the lever arm is 19cm.

EIS0018SM

\$19.95

### Block & Tackle

This model shows how the use of multiple pulleys can increase the mechanical advantage. Size: 17 x 12 x 22cm.

EIS0021SM

\$34.95

### Pulley

This model shows mechanical advantage created by pulleys. Size: base 16.5 x 8.9cm and 41cm tall.

EIS0012S

\$27.95

### Wheel & Axle

This model can show how a crane works, as well as several other uses for a wheel and axle. Size: base 24 x 9.5cm. Stands 11.5cm high.

EIS0019SM

\$26.95

### Fulcrum Balance

Study how changing the distance from the fulcrum changes the mechanical advantage. Students can intuitively figure out the balance point for a given set of masses. Size: 22 x 5.5cm with a height of 13.3cm. The lever arm is 45cm long.

EIS0017SM

\$27.95

### Motion Converter

Show your students how rotational motion can be converted into linear motion with this motion converter. The gears are 12cm in diameter and are mounted on a 38.5 x 6.8cm base. The model is 14.5cm tall.

EIS0016SM

\$40.95

### Screw

With large block on the head of the screw to give additional leverage. Size: 20 x 10 x 11cm.

EIS0020SM

\$34.95

### Gear Train

This apparatus can model how gears work at a basic level to make work easier. The base is 16.5 x 8.9cm, 41cm tall.

EIS0011SM

\$54.95

## Block Play Simple Machines Kit

Students get hands-on experience with cause & effect as they raise and lower objects on an elevator, move blocks on a conveyor belt & more. Plus, they'll gain insight into how full-sized machines make big jobs easier. This kit includes one of each of the Conveyor Belt (LS0202), the Elevator (LS0203) and the Sky Crane (LS0204).

LS0200K

Set of 3 \$278.95



~~\$299.85~~  
**\$278<sup>95</sup>**  
 Save \$20.90



### Block Play Simple Machines – Sky Crane

Students turn the crank to activate the pulley system and watch the platform move up and down. The sky crane measures 33cm tall. Accessories not included.

LS0204

\$89.95



### Block Play Simple Machines – Elevator

Students see how simple machines make work easier with our real-working wooden replicas! The wooden platform moves up and down with a spin of the knob. The elevator measures 23cm tall. Accessories not included.

LS0203

\$99.95



### Block Play Simple Machines – Conveyor Belt

Students move a wedge around to see if a change in angle makes work easier or more challenging! The conveyor belt measures 32cm long. Blocks not included.

LS0202

\$109.95

## Simple Machines



### Simple Machines Discovery Set

Students can construct, examine and explain simple machines to develop a deeper understanding of how they make work easier. Contains enough pieces to build a lever, pulley, inclined plane, wheel and axle, and wedge—all at the same time. Modify machines with 4 included weights (two 5g and two 10 g) and 8 included rubber bands to explore effort, force, load, motion and distance. Set of 63 pieces includes Activity Guide.

LER2442

63 pieces \$85.95



### STEM Simple Machines Activity Set

The STEM Simple Machines Activity Set includes a lever board, wedge, pulley with rope and hook, cart with 4 removable wheels, Archimedes screw, 4 barrel weights, as well as 10 double-sided activity cards to build early engineering and problem solving skills. The largest piece (the cart) measures 2.7cm in length x 8.9cm in width. Suitable for ages 3+ years.

LER2824

\$62.95

### K'NEX Introduction to Simple Machines



STEM Education focuses on science, technology, engineering and mathematics concepts taught through problem-solving, discovery, exploratory learning and critical thinking. These K'NEX models offer hands-on learning opportunities that supports these learning outcomes. The inquiry-based lessons challenge students as they build, investigate, problem solve, discuss, and evaluate scientific and design principles in action. Each set comes with teacher's guide. Find more information about each individual set on our website.

KN78610

Levers & Pulleys – 178pc \$79.95

KN78630

Gears – 198pc \$79.95

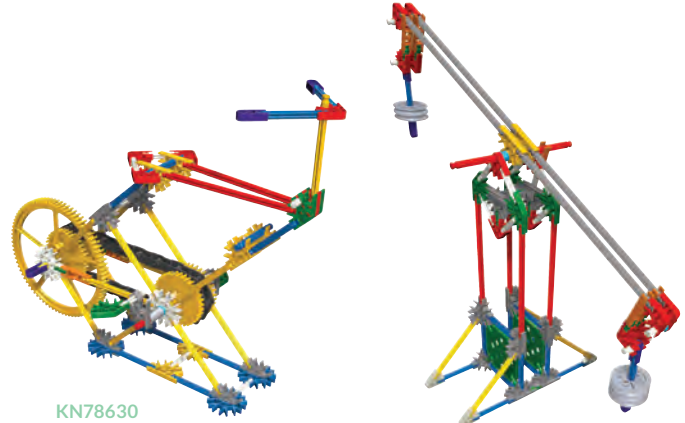

KN78630

KN78610



### Gears! Gears! Gears! Build & Bloom Flower

Set of 116 includes: colourful gears, flowers, butterflies, bees, ladybugs, wiggly stems and more! Endless combinations and designs are possible! Ages 4+ years

LER9214D

116 pieces \$89.95



### Gears! Gears! Gears! Robot Factory

Build and rebuild your own robot factory with this colourful set! Robots spin and bounce around. Robots measure 5.7cm high.

LER9225

\$85.95



### Gears! Gears! Gears! Space Explorers Building Set

Design your own universe with this building set—there are so many possibilities! Place the handle into any gear to make all the pieces move.

LER9217

\$85.95

### Pulleys in Motion Class Set

This versatile classroom pulley set is designed to teach the mechanical principles of pulleys to a whole class. The set contains 18 single sheave pulleys, 12 double sheave pulleys, 12 triple sheave pulleys, 6 spring scales (500g, 50N), a roll of twine, 20 pulley chain links, and the 'Pulleys in Motion' teacher's guide. This 32-page resource introduces students to fundamental pulley concepts and has reproducible student activity sheets and assessment ideas. The focus of the Pulleys in Motion Class Set is to provide hands-on activities that are easily understood, and provide practical experience for the students.



QE37480

\$219.95



### Pulleys Bulk Pack

25 each of 2, 3 and 4cm diameter pulleys with 32mm bores and 25 x 1cm diameter pulley with a 2mm bore for motor shafts.

QE50030

100 pieces \$71.95



### Pulleys

Plastic 50mm diameter, mounted in metal frame with two hooks.

EIS0280K

Single, Double & Triple Sets \$13.95



### Push Fit Motor Pulley

This push fit motor pulley fits directly onto the motor shaft providing a direct drive pulley.

CT23045

50 pieces \$22.95



### Pulleys Tandem

Tandem pulleys are ideal for giving students a clear picture of mechanical advantage and velocity ratio in a pulley system. These pulleys feature free-running plastic sheaves, aluminium frames, and suspension hooks at both ends.

NK50943

Double \$5.50



### Pulleys Coloured

Brightly coloured pulleys that will add fun and excitement to any mechanics experiment. Suitable for young children. Sold individually.

NK50936

Single \$4.50

NK50937

Double \$5.50

NK50938

Triple \$6.50



### Pulleys Metal

Tough, hard-wearing metal pulleys. Sold individually.

NK50930

Single \$3.95

NK50931

Double \$4.95

NK50932

Triple \$5.95

### Pulley Bench Clamp Fitting

Bench clamp 50mm diameter pulley with metal ball bearing carried on a two part aluminium frame. Overall length of the frame (pulley bar) is 110mm. Maximum clamp opening is 25mm.



EIS0296A

\$20.95

### Large Pulley with Universal Clamp

Comprises a 70mm diameter light alloy, with 2 clamping screws for bench and rod support. Clamped to bench up to 38mm thick, screwed to a flat surface or held on 13mm diameter support rod.



EIS0293

\$32.95

## Weights

\$49.75  
**\$47.95**  
Save \$1.80



A total of 1850g

### Iron Weight – Hexagonal with Lifting Ring

Hexagonal iron masses with lifting ring. A set of 5 weights, including 50g, 100g, 200g, 500g and 1kg. Within international tolerance. The weights are also available individually.

EIS0268K	Set of 5	\$47.95
EIS0268A	50g	\$3.95
EIS0268B	100g	\$4.95
EIS0268CM	200g	\$6.95
EIS0268D	500g	\$11.95
EIS0268E	1kg	\$21.95

### Hexagonal Iron Weight with Ring

SER1010001	100g	\$4.95
SER1010002	200g	\$6.95



### Hexagonal Iron Weight with Hook

Ideal for classroom science experiments including the exploration of relationships between objects and weight.

SER1010132	300g	\$16.95
SER1010003	500g	\$12.25
SER1010004	1000g	\$19.95
SER1010180	2000g	\$39.95



### Slotted Weights Set

Use this set to create the desired amount of mass. The slotted weights can be used in experiments involving force, mass and acceleration.

SER1010006	9 x 50 – 500g	\$29.95
SER1010007	9 x 100 – 1000g	\$34.95

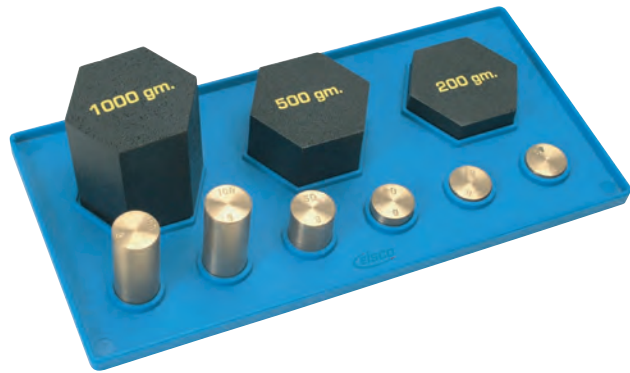

### Weighing Set on Tray

A combined set of accurate steel and brass weights that are housed in a sturdy blue mounted tray. Provides for weighing objects from 10g to 1990g in 10g increments. Contents: 1 of ETC: 1kg, 500g, 200g and 50g plus 2 of each: 100g and 10g.

EIS0039A-N8	Set of 9	\$69.95
-------------	----------	---------

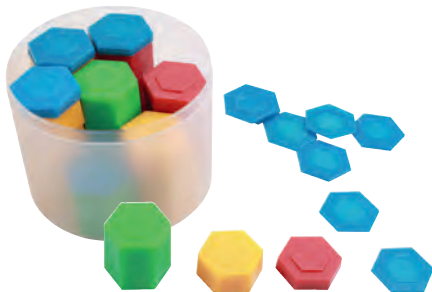

### Plastic Weights

This set of 54 plastic weights consists of 20 x 1g, 20 x 5g, 10 x 10g and 4 x 20g. A total of 300g.

NK1109	Set of 54	\$13.95
--------	-----------	---------



### Slotted Weights

A set of iron, nickel-plated weights for use in forces investigations. Contains 10 slotted weights, each 10g.

NK1118		\$14.95
--------	--	---------

## Light, Colour, Refraction & Reflection Kit

Learn everything about colour mixing, rays of light, reflection and refraction! This kit is a great collection of resources to learn about focal points, angles of light rays and much more. Contents may vary.

ESC007P

\$643.95

### Kit includes

- Optical bench
- Glow in the dark LED torches
  - Set of 12
- Newton colour mixing model
- LED ray box
- Acrylic blocks - Set of 7
- Glass lenses - Set of 6
- Refraction tank - Set of 4
- Wooden lens holder
  - Set of 4
- Refraction & reflection demonstration model
- Mounted mirrors - Set of 10
- Colour paddles - Set of 15



~~\$677.35~~  
**\$643.95**  
 Save \$33.40

## LED Ray Box & Acrylic Blocks Kit

Kit of 1x Acrylic Blocks Set (EIS0571) and 1x LED Ray Box (EIS006RB).

EIS0571K

\$107.95

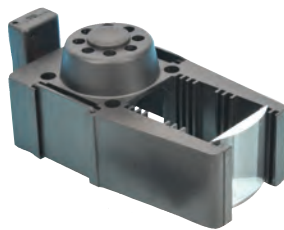

~~\$112.90~~  
**\$107.95**  
 Save \$4.95

### LED Ray Box

This ray box uses LED light and is battery operated, therefore the body of the box will not heat up with high power bulbs. A front opening provides 7 grooves for accessories and lenses. Perfect for experiments with divergent and convergent light rays. Supplied with 2 metres of flex and two 4mm plugs, 12V, 24W B15 bulb, bulb holder, slit plate, aluminium blanking plates and working instructions.

EIS006RB

\$52.95

### Set of 7 Acrylic Blocks

A great set of 7 clear acrylic blocks, all 25mm thick in a wooden storage box. Contents: rectangle (75 x 50mm), semi circular (75mm dia.), triangle 60° x 60° (58mm side), triangle 90° x 45° x 45° (75mm hypotenuse), triangle 90° x 60° x 30° (75mm, hypotenuse), bi-convex (75mm long, curved faces 100mm radius), bi-concave (75mm, curved faces 100mm radius).

EIS0571

Set of 7 \$59.95

## Optical Bench Kit

This enhanced optical set of accessories will allow students to perform a wide range of optical experiments.

EIS0649

\$153.95



## Light & Colour

### Optical Bench & Kit

Optical Bench system is designed to be used with the 'Hodson' Light Box. The kit contains components required for basic optical experiments.

SERHL2240-001 With Light Box \$239.95  
 SERHL2241-001 Without Light Box \$179.95

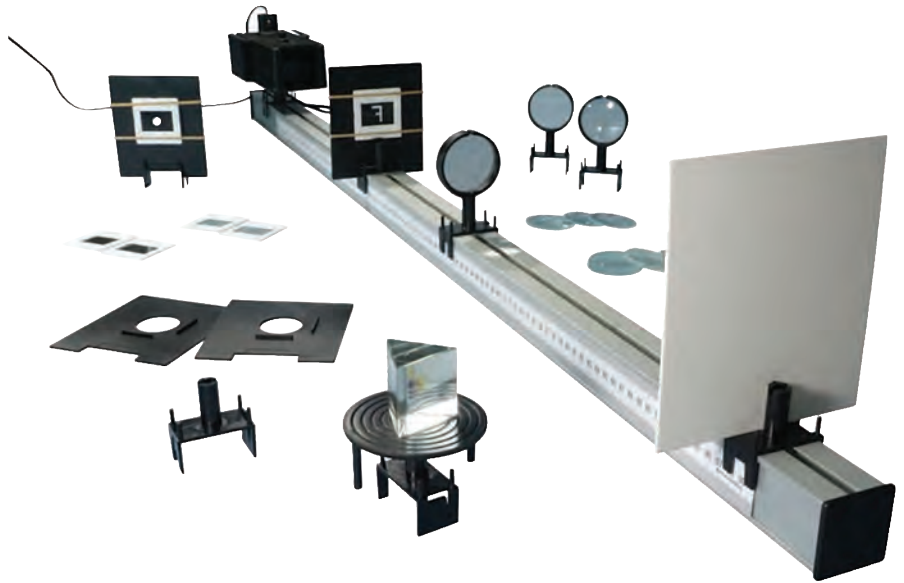

### Colour Mixing Glasses

3+ yrs

Slide coloured lenses in and out of the top of the frame so children can mix colours. For instance, use a red lens and a yellow lens to 'see' in orange. Comes with 6 coloured lenses (2 red, 2 blue, 2 yellow) and 2 'bug eye' lenses.

LER2446 \$22.95



~~\$53.85~~  
**\$42<sup>95</sup>**  
 Save \$10.90

### Colour Paddles

Teach colour combining and the principles of colour mixing with this set of clear plastic colour viewers in 6 colours.

CT8157K Set of 18 \$42.95



~~\$49.90~~  
**\$46<sup>95</sup>**  
 Save \$2.95

### Colour Mixing Paddles Class Pack

This is a useful resource to teach about colours, light, optics, and colour mixing. Enough for colour mixing experiments with the whole class!

IP0353K 18 pieces \$46.95



Set of 10  
**\$85<sup>95</sup>**  
 Save \$3.55



**Prisms - Acrylic**

These prisms can be used to demonstrate the refraction of light, ideal for optics experiments. The equilateral prism is 7.5cm in length x 2.5cm in height. The right angle prism is 7.5cm in length x 2.5cm right angle side x 3.5cm hypotenuse. The kit (EIS0555K) consists of 5 equilateral and 5 right angle prisms.

- EIS0555K 5 x Equilateral + 5 x Right Angle \$85.95
- EIS0554C Equilateral \$8.95
- EIS0555C Right Angle \$8.95



**Light Source - High Power 12V 21W**

This is high quality 12V light source.

- SERHL2013-050 Equilateral \$40.95

**Newtons Colour Disc**

Teach movement and colour in science. This colour disc is useful for demonstrating that white light may be composed from all the spectral colours by rotation of multi-coloured disc. The disc is 17cm diameter, with easy spinning belt drive system. Total height is 32.5cm.



- EIS0583 \$42.95

**Pair of Narrow Prisms**

Designed to provide a progression of ideas from the principles of refraction in prisms to the properties of lenses. Each acrylic prism is in the form of a narrow isosceles triangle 1.5 x 6 x 2cm base, height, thickness. When placed base to base, a convex lens may be simulated. When placed vertex to vertex, a convex lens may be simulated.

- EIS0564 Set of 2 \$12.95



**Glass Block - Rectangular**

Glass block used to demonstrate refraction of light. Made of optical glass with high refractive index.

- EIS0566C 10 x 6 x 1.8cm \$7.95



**Acrylic Prisms**

Break white light into a spectrum of colours with these acrylic prisms. They are an exciting way for children to investigate light.

- NK51234 Set of 7 \$39.95

**Glass Prisms**

- NK11702 Rectangle - 9 x 6 x 3cm - 90° x 60° x 30° \$8.95
- NK11701 Rectangle - 9 x 4.5 x 4.5cm - 90° x 45° x 45° \$8.95
- NK11700 Square - 6 x 6 x 6cm - 60° x 60° x 60° \$8.95

Light & Colour

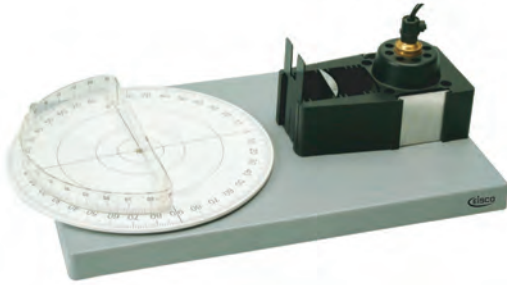

\$156.75  
**\$148<sup>95</sup>**  
 —  
 Save \$7.80



**Refraction & Reflection Kit**

This kit consists of the refraction & reflection model and 4 additional refraction tanks which will allow students to quickly compare the refraction and reflection of light through different liquids.

EIS0614K \$148.95

**Refraction Tank - 200mm Diameter**

This refraction tank is an ideal resource to show refraction and reflection of light in a liquid.

EIS0585B \$12.95

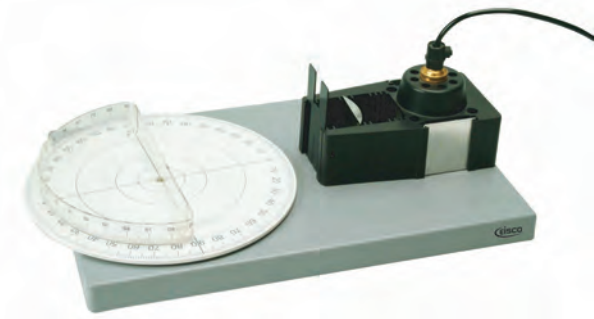

**Refraction & Reflection Demonstration Model**

This model helps students to study the refraction and reflection of light when it travels from one medium into another.

EIS0614A \$104.95

**Splats**

This set of 10 splats includes the 3 primary colours. The 3 secondary colours as well as black, white, clear and double sided mirror.

CT72397 \$43.95



Set of 12  
 Save  
**\$245**



**Torches**

Standard hand torch with a 6cm(diameter) lens. Each torch is 18cm long and requires 2 x D batteries (not included).

DC50228 Each \$4.95  
 CT48012 Set of 12 \$56.95

**Torch Set**

Set includes: 1 x Torches 12p and 12 x Batteries D 2p, provided in a convenient storage container.

TFC51740 Set of 36 \$124.95



**Light Box & Optical Set 12V**

This is the perfect set for reflection, refraction and colour mixing. The light box consists of a light source 12 V, 24W lamp, producing convergent, divergent or parallel beam. On one end, there is an adjustable convex lens, on the other side of the light box is a triple aperture system for colour mixing experiments. The set includes acrylic blocks, 3 mirrors, 2 slit black plates, one with three narrow slits at one end and one narrow slit at the other end. Another black plate with four narrow slits at one end and one wide slit at the other end, 7 mounted colour filters. Supplied with working instructions. Power supply required (not included).



EIS0615

\$146.95



Light Box



Optical Sets

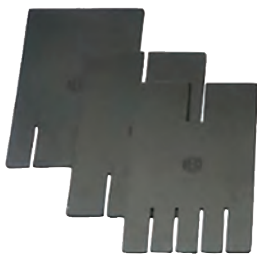

Slit Formers



**Hodson Light Box with Optical Set**

This quality Light Box & Optical Set allows you to perform refraction, reflection, colour, and colour mixing experiments with ease.

The comprehensive set features an easy-to-use virtually unbreakable light box with an adjustable collimating lens, plus a full set of lenses, acrylic blocks, half-round and parabolic mirrors, slit plates, colour cards, and colour filters.

SERHL2060-001

No Power Supply \$149.95

SERHL2061-001

Includes Power Supply \$279.95

SERHL2060-020

Collimating Lens & Slit Formers Only \$79.95

Light, Sound & Spectroscopy



**Spectrometer  
- Student Model**

An economically priced, high-quality, precision manufactured instrument capable of quantitative work.

EIS0619                      \$349.95



**Spectroscope Student with Scale IEC**

This is a very useful device for measuring the wavelength of light.

SERHL3791-001                      \$42.95



**Projection Ripple Tank  
with Strobe & Frequency Meter**

This unit contains state of the art technology. It has full digital control for superior synchronization! Size: 400 x 300 x 600 mm

SER1214007                      \$755.95



**Electric Bell in Vacuum with Plate**

This product demonstrates that the propagation of sound is mediated by the air. In the absence of this medium, the sound waves cannot travel.

SER1052591                      \$136.95



SER1010105



SER1010106



SER1010107

**Spring - Slinky**

Ideal for demonstrating different types of wave motion.

SER1010107	20mm x 1800mm L	\$46.95
SER1010105	75mm x 50mm L	\$9.95
SER1010106	75mm x 100mm L	\$10.95



Save  
**\$155**

**Bi-concave Lenses**

EIS0536-K One of each lens - Set of 8 \$37.95



Save  
**\$140**

**Bi-convex Lenses**

EIS0534-K One of each lens - Set of 8 \$37.95

**Wooden Lens Holder**

Wooden lens holder to take lenses or mirrors up to 76mm diameter. The holder measures 10cm high, with V shape slot to hold a convex or concave lens. The base measures 10 x 5cm. An index mark is engraved on each end of the base. Illustrated lens is not included.



EIS0550A 10cm \$6.50

**Glass Lenses in Box**

Each lens has a diameter of 5cm. With ground and polished faces and ground edges. One each of double convex, plano convex, converging concave-convex, diverging concave-concave, double concave, plano-concave. Supplied in box.

EIS0538A Set of 6 \$30.95



Save  
**\$405**

**Convex & Concave Mirror Set**

This set consists of 5 concave and 5 convex mirrors, to experiment with the reflection of light and to find out how light bends in different ways.

EIS0526K Set of 10 \$76.95

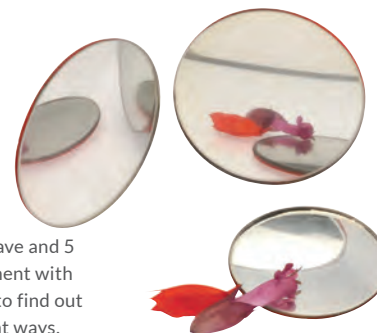

**Concave/Convex Mirror**

These plastic mirrors are safe to use and ideal for simple experiments with light. 10 x 10cm unbreakable.

NK51225 10 pieces \$39.95



**Mirrors**

Quality glass mirrors that demonstrate image distortions. Each measures 5cm (dia). Set of 2 (NK51227K) includes: 1 x Mirror Concave (NK51227) and 1 x Mirror Convex (NK51228).

NK51227K Set of 2 \$8.95



**Concave Mirror - 7.5cm Diameter**

The mirror has a diameter of 7.5cm and a focal length of 75mm. These mirrors are a perfect resource for optical experiments and activities with light rays.

EIS0520H \$7.95



**Convex Mirror - 7.5cm Diameter**

The Convex mirror has a diameter of 7.5cm and a focal length of 75mm.

EIS0526H \$8.25

EIS0515CK  
Save  
**\$255**

**Mounted Plane Glass Mirrors**

These plane glass mirrors are mounted on a wooden block (approx. 20mm thick), which makes them an ideal resource for light reflection and refraction. Silvered back with protective coating.

EIS0515C 10 x 7.5cm - Each \$6.15  
EIS0515CK 10 x 7.5cm - Set of 10 \$58.95  
EIS0515EK 15 x 5cm - Set of 10 \$65.95

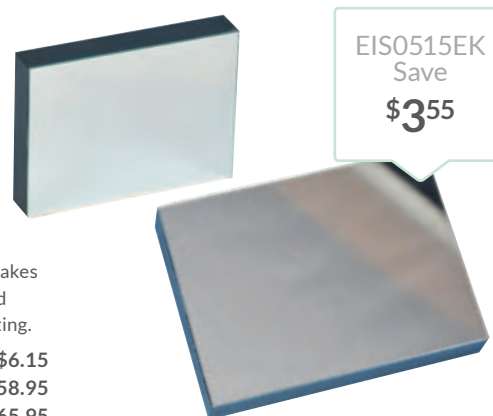

EIS0515EK  
Save  
**\$355**

## Renewable Energy

Set of 4  
**\$580<sup>95</sup>**  
 Save \$30.85



Includes 20 lesson plans



### Learning Lab - Light & Solar Energy Kit

The included Gigo's solar panel not only can generate power, but also can store energy for future use too! Kids can see how convenient solar energy is through building models of a solar vehicle, a solar cable car, a solar recharging station, and more. The set includes 20 lesson plans, including 16 models and 4 creative works, a student workbook, and 3D Smart Manual to view the model on your tablet in 3D.

GG1240 20 Modules \$152.95  
 GG1240K Set of 4 \$580.95



240 pieces

### Solar Educational Kit

Explore solar energy. The kit provides practical ways of exploring solar energy. Comes with a solar cell, fan, wheels and a motor. Simple to use, with instructions included. Year 2 to 6.

EL6690 \$26.95



### 6 in 1 Solar Educational Robot Kit

This kit includes all the parts needed to construct up to six different projects. Choose between a robot, helicopter, plane, windmill, airboat or even a three wheeler! Don't worry about screws, everything snaps together for easy assembly and it's all solar powered so no batteries are required. For the best results, use it in direct sunlight. For cloudy days use a 50W halogen light. Ages 10+ years

EL8936 \$18.95



### Solar Energy Kit

Use knowledge of solar energy in a practical experiment with this kit. A solar panel housed in a plastic box, a low consumption motor with fan, a buzzer and an LED are all included for conducting a series of solar powered activities.

EIS1321 \$78.95



### Solar Generator Small - 0.45 - 200mA

This instrument is a small solar panel. When held to face into bright direct sunlight, the cell will produce about 0.45 volts at a current of 200mA.

SEREM3731-001 \$46.95



### Solar Hobby Cell

This cell has a tough weatherproof coating for premium protection. 1.5V output. Measures 12 x 6.2cm.

EL9012 \$20.95



### Solar Hobby Cell

The apparatus comprises a selenium photo-voltic solar cell. Use with motor to demonstrate the production of electrical energy directly from light energy.

EIS0467L \$44.95

Magnetism Classroom Kits



Super Magnet Classroom Lab Kit

Get magnetised! Everyone can explore hands-on with this complete 224-piece magnetic classroom set for 25 students. Includes: 100 magnetic chips, 100 magnetic paper clips, 10 marbles, 7 magnetic wands, 2 metal bar magnets, 2 metal ring magnets, 2 mini metal horseshoe magnets, 1 large plastic horseshoe magnet, teacher's guide and storage box.

LER2064 224 pieces \$79.95



Magnet Essentials Kit

A great starter set to teach the basic principles of magnetism. The set includes 14 magnetic wands in 7 colours, each measuring 20cm, 14 colourful rectangles (6 x 2.8 x 1.3cm), 20 jumbo magnetic marbles (3.4cm in diameter) and a set of 100 steel ringed chips.

LEL001K 148 pieces \$123.95

\$129.65  
**\$123.95**  
 Save \$5.70



teachables



Mega Classroom Magnet Kit

This mega classroom magnet kit has everything you need to teach the wonders of magnetism. This kit consists of 5 bumper cars, 40 magnetic rings, 10 magnetic characters, 10 magnetic wands, 50 magnetic balls, 5 iron filling caps, 5 giant horseshoe magnets, 10 bar magnets and 200 steel chips, all packed in a handy storage box. The intended use of this kit is for educational purposes. Total of 335 pieces.

FD1001K 335 pieces \$204.95



Lakeshore LEARNING MATERIALS

Magnet Kit

This kit has all your classroom needs, including horseshoe magnets, powerful bar magnets, magnetic wands, compasses and more. Plus, you get handy activity cards filled with 10 fun experiments and a non-fiction book to introduce concepts and reinforce key ideas! Total of over 100 pieces, in a tub.

LS512-1 Over 100 pieces \$174.95



The intended use of the products featured on this page are for educational purposes only. Adult supervision is required. Seek immediate medical attention if magnets are swallowed or inhaled.

# Magnetism



## Tuzzles Magnetic Investigation Box

Students can experiment with magnetism and find out which objects are magnetic and which ones are not with this magnetic investigation box.

BS833

\$57.95



## Magnetic Materials Testing Kit

20 magnetic and non-magnetic objects; some familiar, some not, neatly sealed in clear plastic pots with 2 magnetic wands to test for magnetism. Good for individual and group work, supplied in a strong storage case.

CT50241

\$66.95



## Magnetic Attraction Kit

Among the items in this set are the Bumper Cars and Floating rings to illustrate attraction and repulsion, plus Magnetic Wands and Iron Filing cases to demonstrate magnetic fields.

CT50217

\$129.95



## Large Magnetic Field Wonder Window

Let magnets glide over the top to get an incredible view of magnetism in action! Size 25(L) x 20(H)cm. Illustrated magnets not included.

LS501

\$109.95



## Magnetic Wand Fun Pack

2 x wands, 20 x balls and 100 x chips all in a container.

DC51028

\$24.95

~~\$351.70~~  
**\$316<sup>95</sup>**  
 Save \$34.75



## Magnetic Wand Set

Great value. 30 x wands, 1000 x chips and 300 x balls all in a tub!

TFC51009

\$316.95

The intended use of the products featured on this page are for educational purposes only. Adult supervision is required. Seek immediate medical attention if magnets are swallowed or inhaled.



### Classroom Attraction Kit Level 1

Supplement your science curriculum with comprehensive magnet kits. Investigate motion and stability, matter and its interactions and more.

DC50003

Set of 10 \$239.95



### Jumbo Magnetic Marbles

The jumbo sized magnetic marbles measure approximately 3.4cm in diameter. Watch as they spin, attract and repel each other on a table ... a fun way to learn about magnetism! A set of 10 marbles. Ages 8+ years

LEL160

Set of 10 \$13.95



### Compass Magnet & Bowl Set

This set comprises of colour coded plastic floating compass which contains a powerful magnet and a clear bowl marked with cardinal points of a compass.

CT50295

\$19.95



### STEM Magnets Activity Set

STEM lessons are irresistible when you add the excitement of magnets! Learn all about the properties of magnetism in a fun, colourful way. Pieces include a horseshoe magnet, magnetic post, maze, 4 colour-coded ring magnets, 2 colour-coded bar magnets, 2 magnetic bugs and 2 snap-on cars to bring investigations to life. Also includes 10 double-sided activity cards (20 activities!) about attraction, repulsion and more. Comes with extensive teacher notes. Maze measures 28 x 21.5cm.

LER2833

20 activities \$62.95

5+ yrs



### Bumper Cars and Ring Magnets Set

Set comprises of two bumper cars and four ring magnets. The cars feature slots to accommodate the ring magnets. Students will learn all about the power of magnets as well as the force of magnetic attraction and repulsion. These cars will run away from or towards each other depending on how the magnets are arranged. Magnets are colour-coded and marked with North/South Poles for clarity. Car size: 10 x 5 x 6cm. Rings size: 3.6cm (dia) x 0.8cm. Spare rings available (CT50186).

CT50183

\$19.95

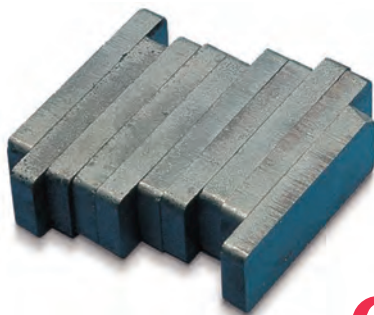

### Ferrite Magnets Set

Ferrite magnets exhibit a high degree of coercive strength, making them more resistant to demagnetisation. Large surface area that is magnetic in dependable ferrite material. Each magnet measures 5 x 1.9 x 0.6cm.

SHW51021

Set of 10 \$16.95



### Ferrite Ring Magnets

Quality ferrite magnets with holes, allowing them to be threaded on string or dowel for further investigation.

SHW51027

2.4cm dia. - Set of 10 \$12.95



### Floating Ring Magnet Set

Students can master the amazing floating magnet trick. They can achieve this by simply stacking the rings with like poles facing each other so they repel.

NK51054

\$10.95

The intended use of the products featured on this page are for educational purposes only. Adult supervision is required. Seek immediate medical attention if magnets are swallowed or inhaled.

# Magnetism

Learn about the repelling or attracting force of magnets



## Magnetic Match Rings

A fun way to learn about magnetism, develop visual matching skills and improve hand/eye co-ordination. Each ring is magnetic. When the rings are stacked they either attract the next ring (snap together), or repel the next ring (push apart or cause it to float). The set consists of 40 challenge cards, 10 Magnetic Rings (3 Blue, 3 Red, 2 Yellow, and 2 green). Each ring is 3.4cm in diameter. Ages 5+ years

LEL0351

\$27.95

## Giant Horseshoe Magnet

High quality, durable monster magnet measures 23cm in height and lifts up to 1.8kgs. Convenient handle allows little hands to grip the magnet comfortably.

FD00001

\$13.95

## Iron Filing Tube

Giant magnetic tube containing a double wall with iron filings between the two layers. Shows a three dimensional view of the magnetic field around the magnet supplied. Magnet is removable, filings are safely encased. 13 x 9cm.

CT50066

\$42.95



## Giant Pole Marbles

A set of 4 ultra powerful colour-coded giant pole marbles which are also clearly marked N and S for easy identification (3cm in diameter). Useful for all kinds of magnetic fun and being colour-coded means that children will see them only attracted to opposing poles. Being large, makes for easy handling. 3cm (diameter).

TFC51084

Set of 4 \$17.95

## Magnetic Marbles in Tub

These plastic cased Magnetic Marbles come in 10 different colours and resemble regular plastic balls. Each Magnetic Marble is 15mm in diameter.

CT50291  
NK1001

Set of 100 \$50.95  
Set of 20 \$11.95



## Horseshoe Magnets Set

High quality and durable chrome steel horseshoe magnets with keepers. Includes plastic wallet. One of each size; 7.5, 10 and 12.5cm.

CT50102

Set of 3 \$59.95



## Iron Filings in Case

An affordable way to demonstrate magnetic attraction! This durable plastic case is firmly sealed to prevent mess or loss of the iron filings. Measures 9.5 x 6.7 x 1.2cm.

LEL0220  
LEL0220K

\$4.95  
Set of 10 \$47.95



Set of 10  
Save  
\$155

The intended use of the products featured on this page are for educational purposes only. Adult supervision is required. Seek immediate medical attention if magnets are swallowed or inhaled.





### Iron Filings Shaker

Handy solution for magnetic flux experiments. Loose iron filings encased in a plastic shaker. 225g approx.

CT0611

\$13.95



### Large Ferrite Block Magnet

Painted bar magnet with red and blue poles, stamped with 'N' & 'S'. DC51008 bar magnets measure 15 x 10 x 50mm. TFC50086 measures 1.4 x 1 x 5cm

DC51008

Each \$1.95

TFC50086

Set of 30 \$53.95



### Steel Ringed Chips

These may look like your regular chips but they actually contain a metallic ring on the inside of each one making it easy for magnets to pick them up. Chips are sonically welded for extra durability. Supplied in assorted colours. Ages 6+ years

LEL0222

Set of 100 \$5.95

TFC51076

Set of 500 \$30.95

TFC51073

Set of 1000 \$63.95

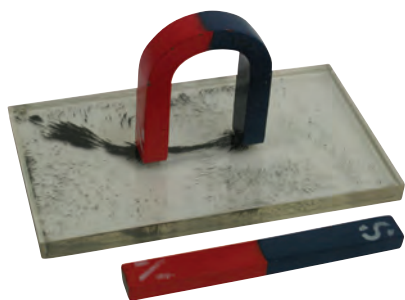

### Magnetic Field Demonstrator - 2D Acrylic

Magnetic Field Demonstration 2D liquid with magnets. Acrylic block (flat) filled with light oil & filings.

SER1052589

\$28.95



### Magnetic Field Demonstrator - 3D Acrylic

The demonstrator is filled with oil and filings with centre hole. Insert magnet into centre hole & a dimensional magnetic field develops for easy viewing. Acrylic block 75x75x75mm.

SER1052593

\$49.95



### Magnetic Rectangles

These magnetic rectangles measure 6 x 2.8 x 1.3cm approximately and are supplied in a set of 7. The set comes in 7 vibrant colours.

LEL336

Set of 7 \$17.95



### Regular Magnets Rect 100p

Pack of 100 rectangular magnets. Ideal for magnetism and STEM activities.

DC51017

\$39.95



### Regular Magnets Rnd 15mm 100p

Pack of 100 ensures there's plenty to go around the classroom for a long time to come. Ideal for magnetism and STEM activities.

DC51013

\$19.95



### Magnetic Wands

Great for scientific discovery and exploration. Magnetic wands are powerful, colourful and durable. 6 brilliant colours.

NK51070

Each \$3.50

NK51071

Set of 6 \$19.95



The intended use of the products featured on this page are for educational purposes only. Adult supervision is required. Seek immediate medical attention if magnets are swallowed or inhaled.

## Magnetism



### Magnetic Wands

These magnetic wands are perfect for the study of magnets and their effects on different materials.

LEL333

Set of 7 \$29.95



### Metal Disc Set

Ideal for experiments to demonstrate magnetic properties and classifications of metals. Includes discs of brass, copper, bronze, nickel silver, mild steel, stainless steel, zinc and aluminium. Discs are stamped for identification. 2.5cm(dia). Set of 16 (EIS0798B) contains 8 stamped and 8 blank discs.

SHW51034

Set of 8 \$16.95

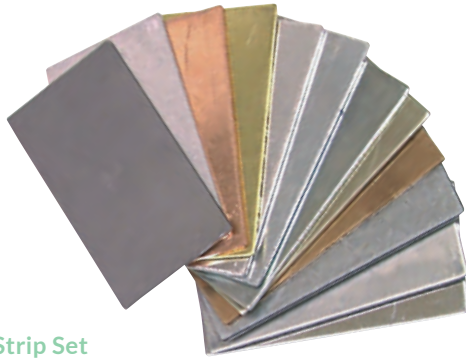

### Metal Strip Set

Set includes strips of soft aluminium, hard aluminium, magnetic stainless steel, non-magnetic stainless steel, zinc, zinc plate, nickel silver, bronze, galvanised steel, mild steel, copper and brass, stamped with letter to identify metal. Ideal for experiments to demonstrate magnetic properties and classifications of metals. Strips measure 50 x 25mm.

CT50147

Set of 12 \$39.95

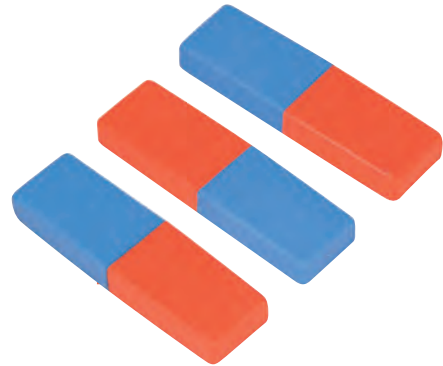

### Plastic Cased Bar Magnets

Red and blue plastic covered bar magnets. These magnets are attractive as well as an easy way to teach magnetic attraction and repulsion. Ages 8+ years

EIS7850

Set of 10 \$40.95



### Plastic Ring Magnets

These plastic Ring Magnets come with a central hole and crossbar, for use in experimentation. Inside, they house powerful ceramic magnets and are marked with North/South Poles. Rings size: 3.6cm (dia) x 0.8cm. Can be used with Bumper Cars (CT50183).

CT50186

Pack of 4 \$10.95



### Round Iron Filing Discs

Filings encased in a plastic bubble, used to observe the effects of invisible magnetic fields. Supplied in a set of 10 discs. Each disc measures 8.5cm in diameter.

CT50351

Set of 10 \$39.95



### Super Magnets

Design allows students to safely experience first hand the force of neodymium which is currently the world's strongest permanent magnet.

CT50209

2 pieces \$39.95

The intended use of the products featured on this page are for educational purposes only. Adult supervision is required. Seek immediate medical attention if magnets are swallowed or inhaled.



**Electromagnet Kit – Basic**

Basic Electromagnet Kit for primary educational use with 6V torch battery, two lead wires with alligator clips, one electromagnet and a storage container.

DC51092



\$48.95



**Induction Kit – Student Build Kit**

This kit has everything that is required to study electrical induction, electromagnets, motors, ac/dc motors, basic transformers, series and more.

SER1035735

\$149.95

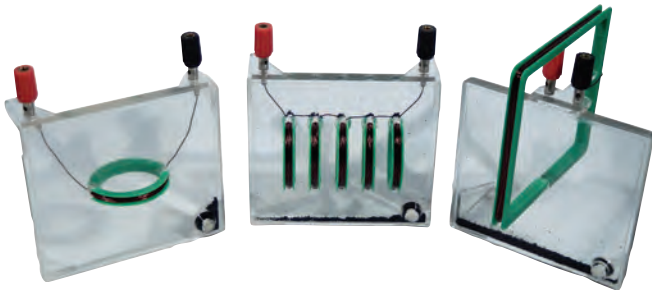

**Electromagnetic Field Demonstrator**

Visualize magnetic fields with this electromagnetic field demonstrator.

SER1052336

\$69.95



**Ampere's Rule Apparatus**

Investigate how electricity running through a conductor or wire creates a magnetic field.

SER1055006

\$42.95



**Electromagnet Science Kit**

Experiment with the power of magnets while building chimes, buzzers, a motor and your own private telegraph system!

SER1055998

\$59.95



**Electromagnet**

Soft iron U bend 10cm high with coils, connectors and keeper, for use with 4.5 to 9 volt DC supply. Demonstrates that soft iron becomes a magnet in the presence of an electric field. Comes supplied with full supporting teacher's notes.

NK51091

\$28.95



**Electromagnet Demonstration**

This shows the magnetic force when electricity flows through metals and how it stops when the current is disconnected. It has an 80kg lift, and is 1.5V.

SER1055011

\$57.95

The intended use of the products featured on this page are for educational purposes only. Adult supervision is required. Seek immediate medical attention if magnets are swallowed or inhaled.

## Electricity Kits



### Economy Electricity Kit

A basic assortment of circuit components. Contents: 10x MES lamp holders, 10x MES bulbs, 1x 6V buzzer with connecting leads, 1x electric motor 3-6V, 5x DPDT slide switches, 1x 1.5V cell holder and 10x crocodile leads. Ages 6+ years

EIS1057

\$48.95



### Electricity Large Group Pack

Caters for 12-16 children.

DC51100

\$251.95

#### Includes:

- 4 x Motor Medium Torque 4.5V
- 4 x D Batteries - Heavy Duty 2 pack
- 8 x Battery Holder 1D Leads
- 4 x LED Light 0.5cm Red
- 4 x LED Light 0.5cm Green
- 4 x LED Light 0.5cm Yellow
- 2 x Bulbs Screw-In 2.5V 10 piece
- 8 x Bulb Holder Fahnstock
- 4 x Electric Buzzer
- 2 x Lead Wires with Alligator Clips 10 piece
- 2 piece
- 4 x Slide Switch
- 4 x Contact Switch
- 4 x Propeller Twin Blade
- 4 x Wooden Bases

- 1 x Wire Cable White
- 1 x Wire Stripper Automatic
- 1 x Screwdriver Flathead
- 1 x Screwdriver Phillips Head
- 1 x Paper Clips Medium 100 piece
- 1 x Split Pins 100 piece
- 1 x Thumb Tacks 100 piece
- 1 x Know How Switched on Exploring Electricity Book
- 2 x Storage Containers

~~\$276.81~~  
**\$251.95**

Save \$24.86

## Electricity Classroom Kits

These electricity kits are designed as an alternative to the 'circuit-board' to teach introductory electricity. The kits include well structured instructional material and robust components mounted on tough, plastic bases, each with two 4mm sockets. Each of the sets is packed in polystyrene trays for protection. For full specifications per set, please refer to our website.

## Electricity Class Kit

This kit includes Basic Electricity Kits A, B, C and D.

EIS2010K

\$674.95



~~\$869.80~~  
**\$674.95**

Save \$194.85

### Components

- 12x D-Sided battery holders (without batteries)
- 4x Electrode holders
- 12x 4mm leads black 10cm
- 4x 4mm leads black 25cm
- 12x 4mm leads red 10cm
- 4x 4mm leads red 25cm
- 8x Crocodile clips
- 4x Universal clips
- 4x Change-over switches
- 8x Push switches
- 40x Bulbs (4.5V, 0.3A)
- 20x Bulb Holders
- 12x Carbon rods
- 8x Soft iron rods
- 4x Silicon diodes
- 50g 'Eureka' wire bare
  - 34swg
  - 50m Copper wire bare - 20swg
  - 50m Insulated copper wire
- 1x Pack of steel wool
- 4x Fixed resistors
- 4x Rheostat units
- 1x Copper foil sheet - 1 x 15cm
- 1x Teacher's book
- 2x Student books
- 2x Polystyrene storage trays

### Basic Electricity Kit A

This kit is suitable for a group of up to 6 students. The manual included introduces each of the equipment and a range of tasks and investigations.

EIS2011

37 pieces \$131.95

#### Components

- 6x D-sized battery holders (without batteries)
- 6x Bulbs in holders
- 3x Press switches
- 3x Two-way switches
- 18x Connecting leads
- Teacher Booklet

### Basic Electricity Kit B

Each class needs only one of this Basic Electricity Kit B.

EIS2012

56 pieces \$133.95

#### Components

- 20 Replacement bulbs
- 4x Variable resistors
- 3x Motors
- 3x Buzzers
- 2x Electrodes holders
- 3x Diodes
- 3x Fixed resistors
- 4x Universal clips with 8 crocodile clips
- 6x Steel rods
- 6x Carbon rods
- Reel of plastic coated wire
- Manual

### Basic Electricity Kit C

The work cards included cover the following subjects: lighting a lamp, using a switch, lamps in series and parallel, conductors and insulators, heat from electricity, using motors, a model house, and making an electromagnet.

EIS2014

56 pieces \$133.95

#### Components

- 6 D-battery holders (batteries not included)
- 6 Bulb holders
- 6 Bulbs
- 3 On/Off switches
- 2 Two-way switches
- Buzzer
- Motor
- Reel of nichrome wire
- 10 Crocodile leads

### Basic Electricity Kit D

The Basic Electricity Kit has been designed as a low-cost, attractive and flexible alternative to the 'circuit-board' approach to investigate simple circuits. Each component such as the switch, light bulb holder, rheostat, etc., is mounted on its own individual plastic panel with 4mm sockets. The panels are then formed into circuits by connecting them together using 4mm stackable leads.

EIS2010

172 pieces \$469.95



Save  
**\$1138**

**Electricity Starter Pack**

This Electricity Starter Pack is an ideal set for introductory electronics! Electricity sets are a must-have for your science classroom.

DC51101 ~~\$166.33~~ \$154.95



Save  
**\$4660**

**Electricity Class Pack**

This pack is designed to ensure that a varied set of electricity resources is on hand to perform hands-on electricity and circuit experiments with your students.

SCK001 Set of 271 ~~\$945.55~~ \$898.95

Includes 20 lesson plans

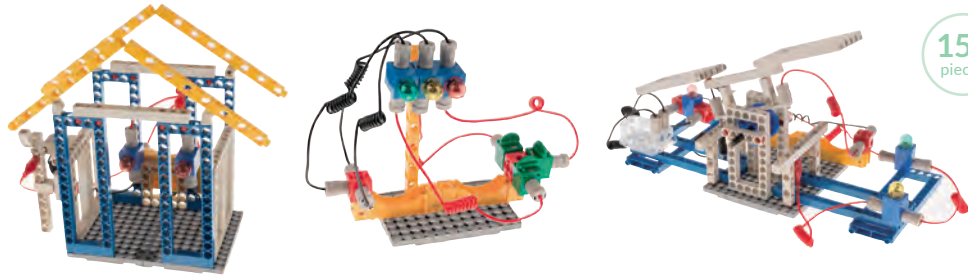

156 pieces

**Learning Lab – Electricity & Circuit Kit**

Using Gigo's Learning Lab electrical building blocks, kids will learn about series and parallel connection, as well as simple circuit designs by assembling common devices from our daily lives, such as a traffic light, an alarm and a torch, developing knowledge of electricity in the process. The set includes 20 lesson plans, including 16 models and 4 creative works, a student workbook, and 3D Smart Manual to view the model on your tablet in 3D.

GG1236 20 Modules \$154.95  
GG1236K Set of 4 \$588.95



Set of 4  
**\$588<sup>95</sup>**  
Save \$30.85

Over 180 experiments



**Click Electronics Explorers Kit**

Over 180 exciting experiments! This explorer's kit is designed to teach children about motors, switches, sound and light. Students learn about resistance, voltage, current and the relation between them, while doing exciting experiments. Simply snap the components together! Comes with an extensive guide full of experiments and step-by-step instructions.

Ages 7+ years

NK1005 \$81.95

Over 1200 experiments



**Click Electronics Extreme Kit**

Over 1200 exciting experiments! The extreme kit is specially designed to further challenge the students and build upon the skills already learnt and to increase knowledge of the principles of electronics in a fun way. Students can experiment by designing their own circuits and using real-life situations as inspiration. Find out about motors, switches, light, sound modules, MW radio, sensors, FM radio, resistance, capacitance, sound recording and more. Simply snap the components together! Comes with an extensive instruction guide.

Ages 11+ years

NK1006 \$167.95

Circuits

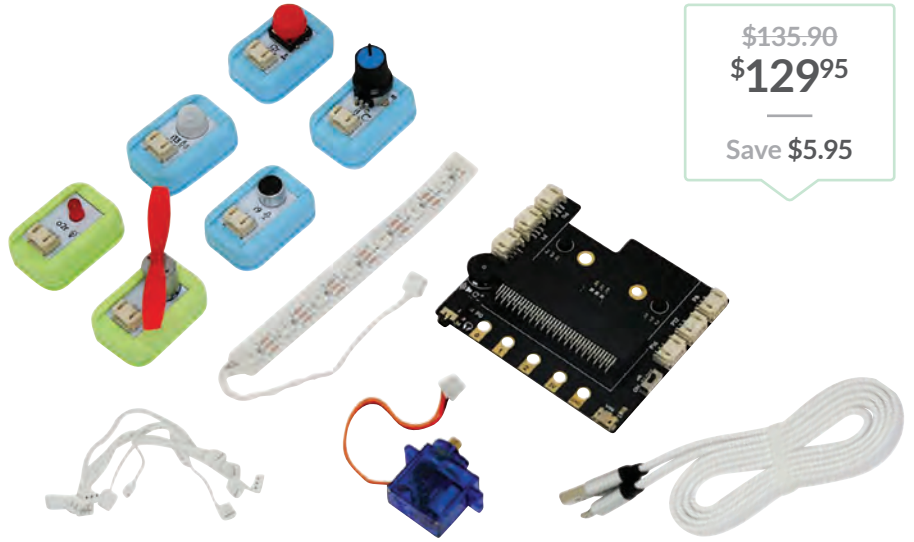

\$135.90  
**\$129.95**  
 —  
 Save \$5.95

**Boson Starter Kit for micro:bit**

This kit includes 8 modules, covering most popular digital and analog sensors and actuators, supporting sound, light and motion interaction.

DFR086 Starter Kit \$129.95  
 DFR086K Starter Kit & micro:bit \$109.95



**Boson - LED Module - Output**

Light up the room with the Boson LED module. Create your own automatic lamp using the sound sensor and other blocks, the possibilities are endless.

DFR017-R Red \$10.95  
 DFR017-G Green \$10.95  
 DFR017-B Blue \$10.95



**Boson - Bright Light LED - Output**

Light up the room with the Boson Bright Light LED module. Create your own automatic lamp using the sound sensor and other blocks, the possibilities are endless.

DFR016 \$10.95



**Boson - Buzzer Module - Output**

The Buzzer module can be easily manipulated by other sensors to create sound. Program the Buzzer to interact with other blocks.

DFR020 \$10.95



**Boson - OLED Module - Output**

The OLED Screen Module is a small screen that can display instant data.

DFR044 \$55.95



**Boson - Fan Module - Output**

The Fan module is a small block a part of the Boson range. Use in combination with other modules to create a circuit.

DFR021 \$16.50



**Boson - Expansion Board for micro:bit**

The Boson expansion Board for micro:bit allows you to combine the Boson modules with micro:bit.

DFR521 \$19.95



**Boson - Motion Sensor - Input**

This Motion Sensor module can be used to sense movement in a room. Program this module to set off an alarm when someone has entered your room!

DFR013 \$24.95

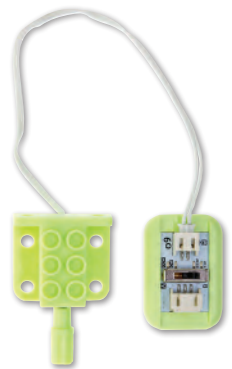

**Boson - Module - Output**

Create your own car, fan or even robot with the motor module.

DFR024 \$19.95



### Boson – Multicolour String Light – Output

The light can emit diverse colours of light. Change the colour or brightness of the lights via signals from other modules.

DFR019

\$26.95



### Boson – Self Locking Switch – Input

The set is much like the button module, but instead of bouncing back up the switch it will stay locked in until pushed again.

DFR003

\$10.95

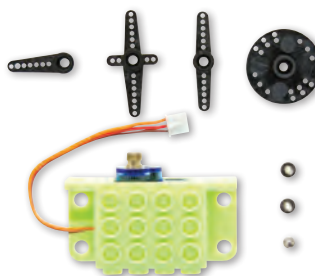

### Boson – Servo Module – Output

Create a robot and use this block to make your robot walk or move its arms.

DFR025

\$21.95



### Boson – Push Button – Input

The Yellow Push Button Module can be used for a range of different activities, turn on a light, play a tune, the possibilities are endless.

DFR002-Y

Yellow \$10.95

### Makey Makey Classic

It is a simple circuit board that lets you reprogram the world around you by connecting. Turn everyday objects into touch pads and combine them with the internet.

MKK001

\$69.95

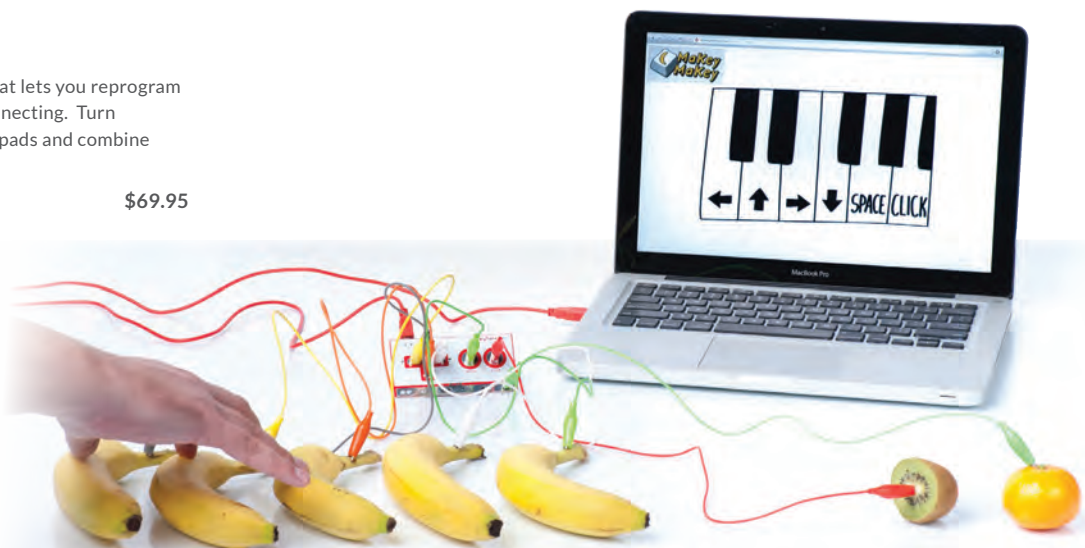

### Makey Makey STEM Pack – Classroom Invent Kit

This kit consists of Makey Makey Classics, alligator clips, connector wires and Makey Makey-Optimised Conductive 6B pencils.

MKK003

\$1,199.95

Circuits

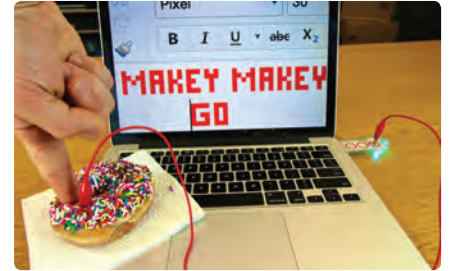
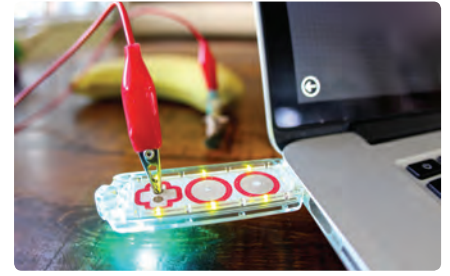

Makey Makey GO

This kit consists of Makey Makey Classics, alligator clips, connector wires and Makey Makey-Optimised Conductive 6B pencils.

MKK002

\$44.95

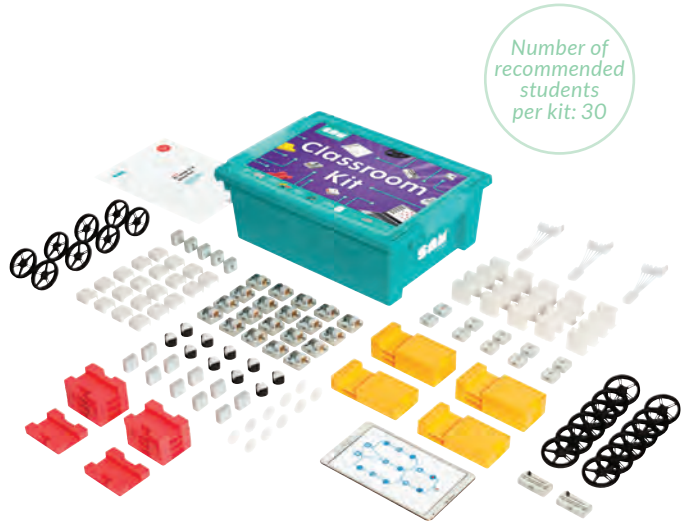

Number of recommended students per kit: 30

SAM Labs – SAM Classroom Kit

This kit is extremely versatile allowing for diverse and engaging lesson plans of various difficulties and curriculum objectives to be completed with just the one kit.

SL006

\$1,899.95



littleBits 9V Battery & Cable

This package contains a 9V alkaline battery and a cable to connect it to the power Bits module.

LIB512

\$10.95

littleBits CloudBit

The littleBits cloudBit is the easiest way to create internet-connected devices. You can now snap the internet to anything!

LIB684

\$129.95

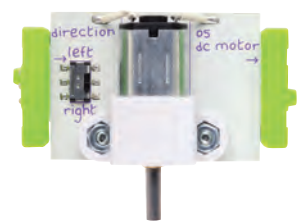

littleBits DC Motor Module

It rotates a shaft when you send it an ON signal. It even has a switch to set the direction of rotation!

LB205

\$59.95

littleBits CodeBit

The codeBit levels up your littleBits circuits by allowing you to program how your Bits work.

LIB153

\$129.95





### littleBits Code Education Kit

An intro to coding in the classroom that engages students through an activity they love: making and playing games. The littleBits Code Kit combines electronic building blocks with approachable drag-and-drop block-based programming, providing a foundation of coding as a creative tool that can power real-world inventions. The kit includes 16 Bits, 30+ accessories, tons of resources and a computer-based Code Kit app, 100+ activities and 10 lessons.

LIB010

\$549.95



### littleBits Intro Kit

With a range of Bits that move, light up, and make noise, students gain skills by learning how technology is built.

LIB823

\$199.95



### littleBits Mini Kit - 5 Modules

LittleBits is an open source library of electronic modules that snap together with tiny magnets for prototyping, learning, and fun.

LIB600K

\$159.95

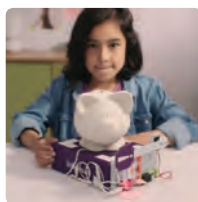
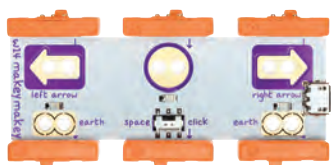

### littleBits Makey Makey Module

Now you can use everyday objects to trigger your Bits and control cursors on your computer's keyboard, or even control your computer.

LIB846

\$99.95

### littleBits LED Matrix

Set it to SIGNAL mode to play with the preset programs, or switch it to SERIAL mode to program your own graphics with the codeBit.

LIB028

\$109.95



### littleBits Long LED Module

This is one of the many littleBits modules. It is a great lighting option.

LIB202

\$26.95



### littleBits Power Module

This power Bit lets you use a 9 volt battery to supply electricity to your littleBits.

LIB101

\$15.95



## Electricity



### Junior Electronic Blocks Kit

This kit contains all the necessary components to investigate core concepts in introductory electronics.

SER1052597

\$42.95



### Electroflash Electronics Kit

This kit is excellent for teaching junior or senior electricity in science and electronics at all levels.

SER1015001

\$202.95

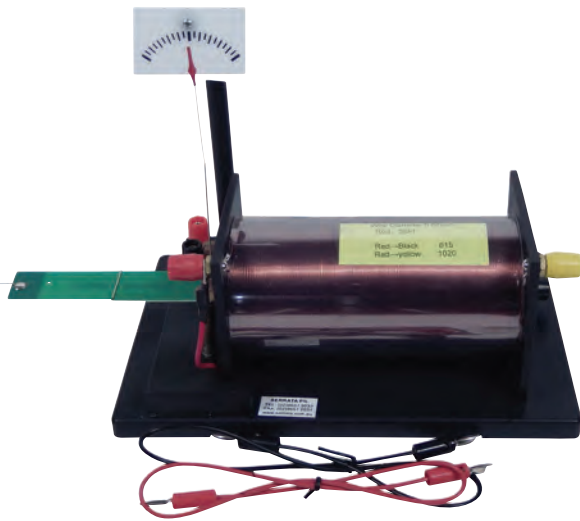

### Complete Current Balance Kit with Pointer

This kit can be used to determine how the magnitude of the magnetic field near the centre of a long solenoid varies with the current in the solenoid.

SER1052036

\$134.95



### Air Core Solenoid - 710 Turn, 3 to 5A

This Air Core Solenoid provides a useful magnetic field for many experiments in magnetism and electricity.

SER1011095

\$42.95



### Crocodile Clip Pack

Used in school laboratories to quickly and cheaply assemble circuits. Connect various components to wires. Made from nickel plated steel. Each clip is 3.5cm and will accept a 4mm plug.

NK20510

Pack of 50 \$13.95

### Alligator Clips

These clips allow quick temporary electrical connection.

SER1017001

\$4.95



### Connecting Leads with Crocodile Clip - Black

These connecting leads are insulated with a crocodile clip on both ends, for 4mm plug. Available in 3 lengths.

EIS1053A

30cm long \$3.05

EIS1053C

50cm long \$3.40

EIS1053G

75cm long \$4.05



### Lead Wires with Alligator Clips

Ready made leads approximately 50cm long in assorted colours. Plastic coated to guard against shocks. The sharp pointed teeth attached to each clip ensures a good connection.

NK51171

Set of 10 \$7.95

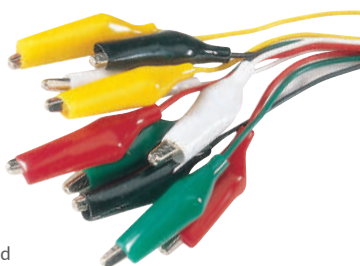

### Cell Holders Stackable D-Size

Designed to link together in parallel or series to extend capacity or voltage. Supplied individually. Multiples shown. Illustrated battery not included.

EIS0957A

\$3.95





### Demonstration Meter Scales - Volts & Amps

This meter is supplied with scales to allow a large and varied amount of electrical measurement in both DC volts and DC amps.

SER1052037B \$299.95

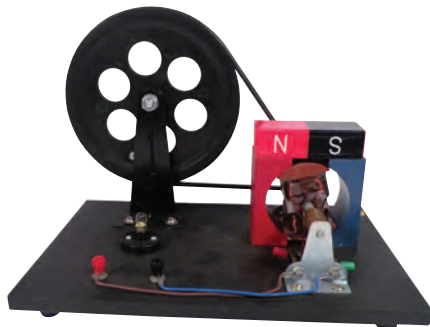

### Hand Crank AC/DC Generator

This is a hand driven generator mounted on base.

SER1052034 \$88.95



### Buzzer

Mounted on base. A low current buzzer of 2mA approximate capacity.

EIS1056H \$14.95



### Digital Ammeter

Portable digital ammeter with large LCD display of 3½ digits. Powered by 9 Volt battery, with an accuracy of +1 digit.

EIS1102B \$41.95



### Digital Volt Meter

Portable digital voltmeter with large LCD display of 3½ digits. Powered by 9 Volt battery, with an accuracy of +1 digit. DC voltage ranges: 0 - 199.9 mV - 200 mV, 0 - 1.99 V - 2V, 0 - 19.9 V - 20 V, 0 - 199.9 V - 200 V. DC current ranges: 0 - 199.9 iA - 200 iA, 0 - 1.99 mA - 2mA, 0 - 19.9 mA - 20 mA, 0 - 199.9 mA - 200 mA, 0 - 10 Amp.

EIS1102A \$41.95



### Hand Crank Dynamo

The efficient design produces enough electricity to light a small incandescent light bulb; the faster the crank is turned, the brighter the bulb becomes.

SER1052333 \$19.95

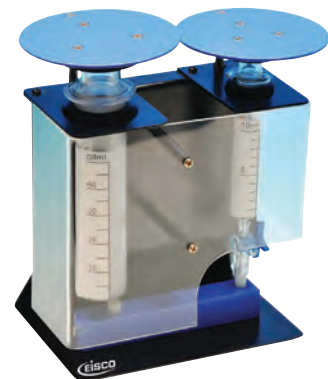

### Hydraulic Press

For demonstrating the transmissibility of fluid pressure and to show how mechanical advantage may be obtained.

EIS0215 \$319.95



### Electric Bell

This electric bell is a mechanical bell that functions by means of an electromagnet. When an electric current is applied, it produces a repetitive bell sound.

NK51731 \$24.95



### Electric Buzzer

Loud noise buzzer comes complete with positive and negative wires attached. Input: 4-15VDC at 15mH. Output: 70dB. Unit measures 1.4cm(H), Base 3.3 x 1.5cm.

NK51165 Each \$3.95  
NK51165-10 Set of 10 \$37.95

## Electricity



### Fountain Connection

Explore the principals of gravity and air vacuums. With the help of two soft drink bottles, use the fountain connection to create a spectacular bubbling water fountain inside the bottle. Includes instructions.

NK50905

\$6.95

### Induced Current Apparatus (Mutual)

Kit is supplied with a pure iron rod and when dropped through the centre of the coils it will induce an electric current.

SER1010135

\$51.95

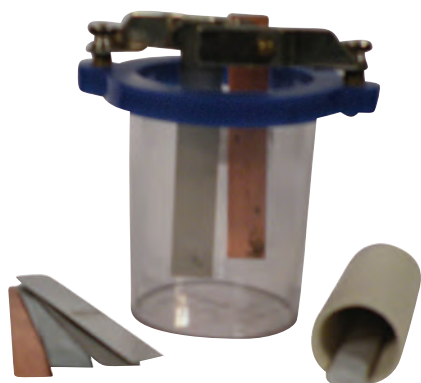

### Galvanic Cell Kit

With this kit you can build a voltaic, coulometer, dry or Daniel cell. It consists of two different metals connected by a salt bridge or individual half-cells.

SER1055015

\$47.95

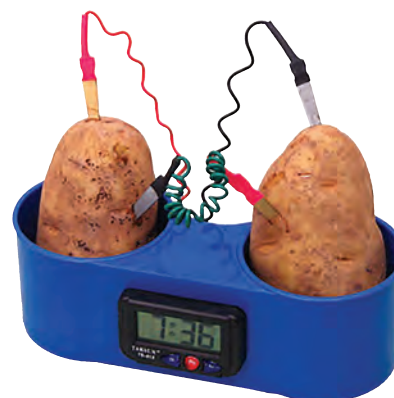

### Fruit Clock

Use the potato electrochemical battery to convert chemical energy to electric energy by a spontaneous electron transfer. Work with any acidic fruit or vegetable.

SER1014190

\$20.70



### Powerful Induction Coil (Ruhmkorf) - 80mm Spark

This very high voltage power source can be used in a variety of physics experiments.

SER1052383

\$499.95



### Millikan's Apparatus with Built-in Power Supply

This apparatus with inbuilt power supplies permits the atomising of a latex solution into small spheres and the rubber hose induces a static charge upon them.

SERAP2131-001

\$699.95

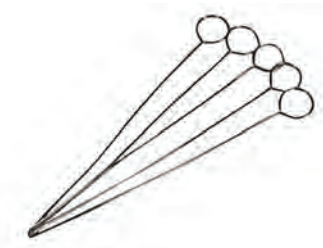

### Nichrome Wire Inoculating Loop

This is made of nichrome wire with 4mm diameter loop.

SER1099004

\$7.95



### Resistance Coil in Clear Case - 10 Ohm

This is a classic item designed for use in resistance measuring bridges.

SEREM2706-001

\$24.95



### Resistance Coils

Resistance coils for studying flow of electricity.

EIS1143A

1 ohm resistance \$7.95

EIS1143C

5 ohm resistance \$7.95



### Fixed Resistor Set - 10 to 100ohms

This set can be used to construct simple circuits.

SER1011025

\$44.95



### Power Supply - 2-12V 5.5A AC DC

This is a compact general purpose power supply to provide switched AC and DC voltages at 2, 4, 6, 8, 10 and 12V. AC and DC at about 5 to 6A.

SERLB2633-001

\$179.95



### Power Supply - 2-12V 10A AC - DC

This is a compact, general purpose power supply to provide switched AC and DC voltages at 2, 4, 6, 8, 10 and 12V. AC and DC at about 8 to 10A.

SERLB2631-001

\$259.95



### Peltier Effect Thermocouple

Thermo-Generator, 2x 4mm sockets permit application of DC to run the cell and the heating and the cooling is very obvious. Ice can form on the cold side.

SERHL4052-001

\$99.95



### Power Supply - 1 Ampere

A compact regulated power supply offering 1.5, 3, 4.5, 6, 9, 12 volts at currents up to 1 Amp.

EIS1323A

\$114.95



### Resistance Coil in Clear Case

This plastic spring clip is ideal for holding components between 1.9 to 2.5cm of diameter in position.

SER1011016

1 ohm \$16.95

SER1011019

10 ohm \$16.95

SER1011017

2 ohm \$16.95

SER1011018

5 ohm \$16.95

## Electricity & Globes



### Lamp Holder Set

Suitable for use with small globes (both 1.5 and 2.5V).

NK20505

Set of 10 \$12.95

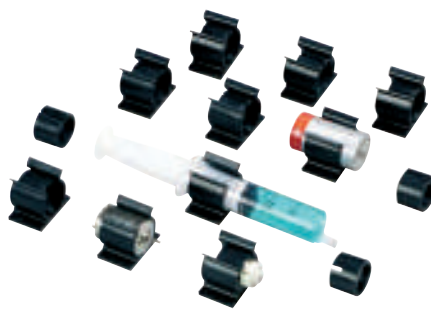

### Universal Mount Clips

This plastic spring clip is ideal for holding components between 1.9 to 2.5cm of diameter in position.

DC51166

\$0.95



### Bulb Holders Economy

Economical basic bulb holder holds one bulb. Supplied as each. Great for all circuitry, light and also electricity experiments.

DC51157

Each \$0.25

DC51157-10K

Set of 10 \$2.50

DC51157-100K

Set of 100 \$28.95



### Metal Brush Rheostat

These rheostats provide resistance in electrical circuits.

SER1052907

11 ohm, 5A \$49.95

SER1052908

50 ohm, 2.3A \$49.95



### Small Globe

These screw-base bulbs will light up any science experiment. Each is 2cm long and 1.2cm in diameter. Pack contains 50 globes. Ages 6+ years

NK20506-02

1.5V - Set of 50 \$14.95

NK20506-04

2.5V - Set of 50 \$17.95



### Bulbs Screw-In

Screw base bulbs are perfect for all of your electricity experiments.

TFC51142-10K

1.5V - Set of 10 \$3.95

TFC51142-100K

1.5V - Set of 100 \$42.95

TFC51142

1.5V - 1 piece \$0.45

DC50143

2.5V - Set of 10 \$4.10

DC50163

2.5V - Set of 100 \$44.95

TFC51140-10K

6V - Set of 10 \$4.95

TFC51140-100K

6V - Set of 100 \$52.95

TFC51140

6V - 1 piece \$0.55

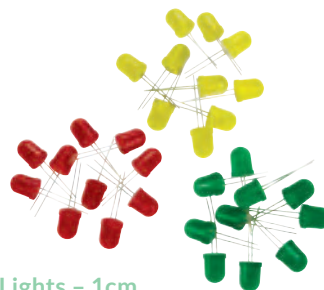

### LED Lights - 1cm

EL0200

Red - 1 piece \$1.10

EL0200-10

Red - Set of 10 \$10.50

EL0210

Yellow - 1 piece \$1.10

EL0210-10

Yellow - Set of 10 \$10.50

EL0205

Green - 1 piece \$1.10

EL0205-10

Green - Set of 10 \$10.50

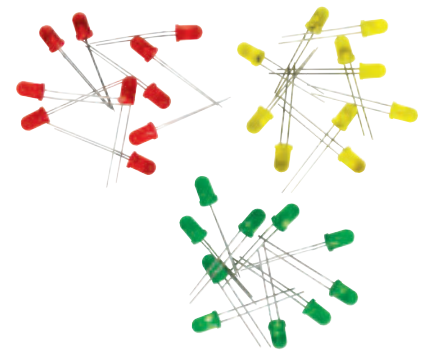

### LED Lights - 0.5cm

EL0150

Red - 1 piece \$0.50

EL0150-10

Red - Set of 10 \$4.80

EL0160

Yellow - 1 piece \$0.50

EL0160-10

Yellow - Set of 10 \$4.80

EL0170

Green - 1 piece \$0.50

EL0170-10

Green - Set of 10 \$4.80



**Lamp on Stand  
MES Type with Terminals**

These can be used to show variation in currents visually.

SER1092015      2.5V Lamp \$7.95



**Lamp on Stand  
SBC Type, with Terminals**

These can be used to show variation in currents visually. 12V x 5Watt Globe bayonet, mounted on base with 2 x 4 mm terminals, Very Popular. An old standard!

SER1099029      12V/5A \$7.95



**Shielded Piggyback  
Banana Leads - 42cm**

These are very strong shielded banana leads which are almost impossible to pull apart.

SER1017012      Pack of 10 - Black \$15.95  
SER1017011      Pack of 10 - Red \$15.95



**Banana Plug - Red/Yellow/Black**

The connectors can be used to join wires.

SER1017002      Pack of 30 \$19.95

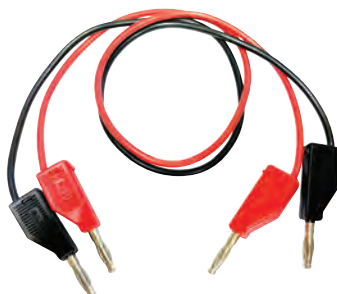

**Piggyback Banana Leads - Black & Red**

The flexible banana leads can be used in laboratories for physics experiments. This pack includes 1 red lead and 1 black lead.

SER1017013      42cm - Pack of 2 \$7.95



**Motor Box**

Reliable electrical motors packaged with plastic spring clips in a box, perfect for all science experiments. Includes 20 x Medium Torque Motor 3V and 10 x Universal Mount Clips. Unbeatable value.

DC51167      \$60.95

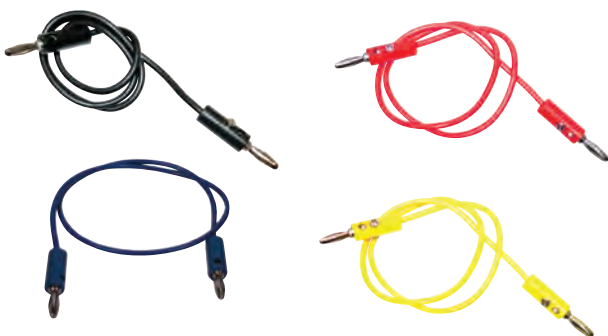

**Standard Banana Leads**

The flexible banana leads can be used in laboratories for physics experiments.

SER1017007      42cm - Black - Pack of 10 \$19.95  
SER1017019      42cm - Blue - Pack of 10 \$19.95  
SER1017008      42cm - Red - Pack of 10 \$19.95  
SER1017009      42cm - Yellow - Pack of 10 \$19.95



**Motor Medium Torque**

Reliable electrical motors. Ideal for all science experiments. Low voltage economy DC motor 3V and medium voltage torque DC motor 4.5V.

NK51160      Low Voltage - Each \$2.40  
NK51160-5K      Low Voltage - Set of 5 ~~\$12.00~~ \$10.95  
NK51160-10      Low Voltage - Set of 10 ~~\$24.00~~ \$22.95  
EIS1004MM      Medium Voltage - Each \$3.05  
EIS1004-5K      Medium Voltage - Set of 5 ~~\$15.25~~ \$13.95  
EIS1004-10K      Medium Voltage - Set of 10 ~~\$30.50~~ \$28.95

## Switches & Wire

Pack of 10  
Save  
**\$1.05**



### Contact Switch

This switch will make contact for as long as you push down on it.

EL0711 Each \$2.50  
EL0711K Set of 10 \$23.95

Pack of 10  
Save  
**\$50c**



### Miniature Slide Switch

A reliable switch with on/off positions. Switch base measures 1.5 x 0.8 x 0.8cm.

EL51196 Each \$1.50  
EL51196K Set of 10 \$14.50

Pack of 10  
Save  
**\$1.55**



### Toggle Switch

A sturdy switch with on/off indicator label. Can be used unmounted or in simple circuits.

EL0572 Each \$2.95  
EL0572K Set of 10 \$27.95

Pack of 10  
Save  
**\$1.55**



### Switch for Electric Circuit Experiment

Used for the study of electrical circuits.

EIS1003 Each \$4.05  
EIS1003K Pack of 10 \$38.95



### Knife Switch

Used for the study of electrical circuits.

EIS1000A

\$6.10



### Contact Key Switch

Excellent for demonstrating morse code. This key switch is used to open and close an electrical circuit momentarily.

NK51194

\$9.95



### Switch - Contact Press Type - Silver Plated P

This is the classical switch used in basic experiments to make or break circuits.

SEREM1010-001

\$19.95



### Switch Contact - Tapping - Key

Close an electrical circuit with a light touch of the key. The circuit remains closed only as long as the key is depressed.

SER1010139

\$9.95



### Wire Cable

The 25cm wire cable black is thin and easy to cut and use. Ideal for use in the science classroom while experimenting with circuits and lighting activities.

NK51173

Black \$7.95

NK51172

Red \$7.95

NK51174

White \$7.95



### Enameled Copper Wire

Use the copper wire to create transformers, inductors, electromagnets and other applications that require tight coils of insulated wire.

EL51712

\$12.95





**Van De Graaff Generator with Accessories Kit - 400Kv**

This unit has been tested to work effectively in high humidity climates without hesitation, which is a rarity amongst these types of generators.

SER1052222 \$499.95



**Gold Leaf Electroscope**

This shows how two similarly charged objects repel.

SER1052028 \$49.95



SER1010141



SER1141001



SER1010498



SER1010142

**Electrostatic Cloth**

Use the different materials to observe how each cloth creates charge carriers.

- SER1010141 Cotton - 30 x 30cm \$1.50
- SER1141001 Rabbit Fur - 10x6cm \$5.95
- SER1010498 Silk - 25x25cm \$2.95
- SER1010142 Wool 30 x 30cm \$2.95

**Electrostatic Rod**

These can be used to create static charges of desired polarity.

- SER1140001 Acrylic - 12 x 300mm \$5.95
- SER1010130 Glass - 10 x 300mm \$2.95
- SEREM3535-001 Nylon - 300 x 10mm \$8.95
- SEREM3522-001 Polystyrene - 10 x 300mm \$5.95
- SER1010131 PVC - 6 x 300mm \$2.95
- SEREM3550-001 Metal Acrylic - 10 x 300mm \$24.95



SER1140001



SER1010130



SEREM3535-001



SEREM3522-001



SER1010131



SEREM3550-001

## Electrochemistry



### Planck's Constant 12V

This contains 2 separate meters. One displays the current and the other displays the backing volts that brings the current to exactly zero.

SERAP2342-001

\$699.95



### Nebula Plasma Globe

This is a plasma globe filled with a mixture of various noble gases with a high-voltage electrode in the centre of the sphere.

SER1127005

\$86.95

### Crooke's Tube

This tube shows the behaviour of electric currents in an electric motor.

SER1052042

\$99.95



SER1010552



SEREM1791-001



SER1010551



SER1010553



SER1010554



SER1010555



SER1010556

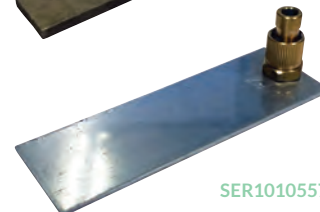

SER1010557

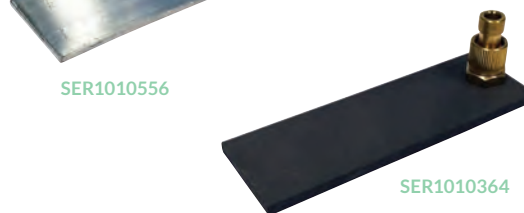

SER1010364

### Electrode

These are high quality electrodes used for electrochemical experiments.

SER1010552	Aluminium - 75 x 25 x 3mm	\$4.20
SER1010551	Copper - Terminal - 75 x 25 x 1.5mm	\$8.95
SER1010553	Iron - Terminal - 75 x 25 x 1.5mm	\$5.20
SEREM1791-001	Lamp Stainless Conductivity	\$35.95
SER1010554	Lead - 75 x 25 x 3mm	\$7.95
SER1010555	Nickel - 75 x 10 x 3mm	\$18.95
SER1010556	Tin - 75 x 25 x 3mm	\$12.95
SER1010557	Zinc - 75 x 25 x 3mm	\$5.95
SER1010364	Carbon 75 x 25 x 3mm	\$8.95

~~\$2,762.70~~  
**\$2,549<sup>95</sup>**  
 Save \$212.75

Bonus Book



**Physical Kit - Foundation to Year 6**

Help students develop an understanding of the concept of motion and energy. These kits assist in understanding that forces affect the behaviour of objects and that energy can be transferred to and from a particular object.

TFC57000PK 6 Kits \$2,549.95

**Physical Science Kit Year 1**

Have fun exploring Light and Sound with this Year 1 Physics kit. Contents may vary.

- Balloons
- Blu Tack
- Candles
- Cellophane - Packet
- Coat Hanger Wire
- Cotton Twine
- Cups
- Gratnells Clip-on Lid
- Gratnells Extra DeepTray
- Mirrors
- Play Money - 20 Cent Coins
- Percussion Set
- Torch

TFC57004 \$330.95

~~\$371.55~~  
**\$330<sup>95</sup>**  
 Save \$40.60

Bonus Book



Light and sound are produced by a range of sources and can be sensed (ACSSU020)



- Recognising senses are used to learn about the world around us: our eyes to detect light, our ears to detect sound, and touch to feel vibrations
- Recognising that objects can be seen when light from sources is available to illuminate them
- Comparing sounds made by musical instruments using characteristics such as loudness, pitch and actions used to make the sound

## Kits, Books & Charts

### Physical Science Kit Year 2

Push and Pull! Have fun investigating these forces with our Year 2 kit. Contents may vary.

- Bags - Plastic Reseal
- Ball - Table Tennis
- Ball - Tennis
- Balloons
- Beakers
- Cellophane
- Corks
- Grattells Clip-on Lid
- Grattells Extra Deep Tray
- Inflatable Globe
- Marbles
- Modelling Clay
- Paper Clips
- Paper Towels - Roll
- Popsticks
- Rubber Bands
- Self-Adhesive Notes
- Spray Bottle

TFC57008

\$184.95

A push or a pull affects how an object moves or changes shape (ACSSU033)



- Exploring ways that objects move on land, through water and in the air
- Exploring how different strengths of pushes and pulls affect the movement of objects
- Identifying toys from different cultures that use the forces of push or pull
- Considering the effects of objects being pulled towards the Earth



Bonus Book

\$223.20  
**\$184.95**

Save \$38.25

### Physical Science Kit Year 4

This kit can be used to support Year 4 students as they extend their knowledge of forces. Contents may vary.

- Balloons
- Card A4 270gsm
- Gloves Disposable
- Grattells Clip-on Lid
- Grattells Jumbo Tray
- Inflatable Globe
- Marbles
- Masking Tape
- Cotton Reels
- Detergent Liquid
- Modelling Clay
- Paper Clips
- Polystyrene Ball
- Self-Adhesive Notes
- Streamers
- Tubing - Clear PVC
- Dominoes

TFC57016

\$264.95

Forces can be exerted by one object on another through direct contact or from a distance (ACSSU076)



- Observing qualitatively how speed is affected by the size of a force
- Exploring how non-contact forces are similar to contact forces in terms of objects pushing and pulling another object
- Comparing and contrasting the effect of friction on different surfaces, such as tyres and shoes on a range of surfaces
- Investigating the effect of forces on the behaviour of an object through actions such as throwing, dropping, bouncing and rolling



Bonus Book

\$296.20  
**\$264.95**

Save \$31.25

### Physical Science Kit Year 5

Teachers can use this kit with their Year 5 students as they investigate how light can be absorbed, reflected and refracted. Contents may vary.

- Bags - Plastic Reseal
- Battery
- Blu Tack
- Card A4 270gsm
- Cellophane
- Counters Mini Motors
- Cups
- Dessert Spoon Metal
- Foil (Aluminium) - Roll
- Glue Stick
- Gratnells Clip-on Lid
- Gratnells Jumbo Tray
- Masking Tape
- Mirrors
- Paper Towels - Roll
- Popsticks
- Self-Adhesive Notes
- Split Pins
- Straws
- Tissue Paper
- Torch

TFC57020 \$318.95

\$347.55  
**\$318.95**  
 Save \$28.60

Bonus Book

Light from a source forms shadows and can be absorbed, reflected and refracted (ACSSU080)

- Drawing simple labelled ray diagrams to show the paths of light from a source to our eyes
- Comparing shadows from point and extended light sources such as torches and fluorescent tubes
- Classifying materials as transparent, opaque or translucent based on whether light passes through them or is absorbed
- Recognising that the colour of an object depends on the properties of the object and the colour of the light source
- Exploring the use of mirrors to demonstrate the reflection of light
- Recognising the refraction of light at the surfaces of different transparent materials, such as when light travels from air to water or air to glass



### Physical Science Year 6

All about Electricity! This exciting kit is suitable for use with Year 6 students as they study electrical circuits and how electricity can be generated.

- Adhesive Tape
- Alligator Clips with Leads
- Alnico Bar Magnets
- Balloons
- Battery - AA
- Battery - D
- Battery - Watch
- Battery Holder 2 x AA
- Blu Tack
- Bulb Holders
- Bulbs - 1.5v
- Buzzer Electric
- Card A4 270gsm
- Cellophane
- Ceramic Magnets Round
- Clothes Pegs
- Corrugated Plastic Sheets
- Cotton Twine
- Cups
- Cutting Knife
- Dessert Spoon
- Digital Multimeter
- Copper Wire
- Ferrite Magnets Set
- Foil (Aluminium) - Roll
- Foil Tray
- Gratnells Clip-on Lid
- Gratnells Jumbo Trays
- Hessian
- Light Bulbs Collection
- Magnifying Glass
- Manilla Folders
- Marker Permanent
- Masking Tape
- Measuring Cup 250ml
- Nails - Galvanised
- Paper Clips
- Rubber Bands
- Self-Adhesive Notes
- Skewers
- Split Pins
- Stopwatch
- Switch
- Thermometer Immersion
- Toothpicks
- Torch
- Wire Cable - Black
- Wire Cable - Red
- Wire Cable - White
- Wire Copper
- Wire Stripper

TFC57024 \$939.95

\$968.05  
**\$939.95**  
 Save \$28.10

Bonus Book

Electrical circuits provide a means of transferring and transforming electricity (ACSSU097)

- Recognising the need for a complete circuit to allow the flow of electricity
- Investigating different electrical conductors and insulators
- Exploring the features of electrical devices such as switches and light globes

Energy from a variety of sources can be used to generate electricity (ACSSU219)

- Investigating how moving air and water can turn turbines to generate electricity
- Investigating the use of solar panels
- Considering whether an energy source is sustainable



## Kits, Books & Charts

Set of 6  
**\$113<sup>95</sup>**  
 —  
 Save \$5.75

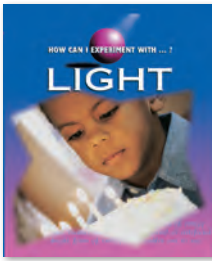
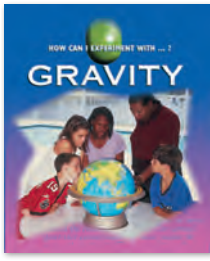
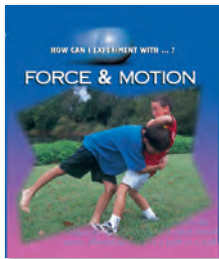
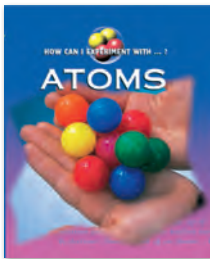

### How can I experiment with?

These hands-on books gives students many opportunities to experiment with atoms, electricity, forces & motion, gravity, light or sound.

RP0080K	Set of 6 books	\$113.95
RP0080	Atoms Book	\$19.95
RP0165	Electricity Book	\$19.95
RP0172	Force & Motion Book	\$19.95
RP0325	Gravity Book	\$19.95
RP0349	Light Book	\$19.95
RP0424	Sound Book	\$19.95

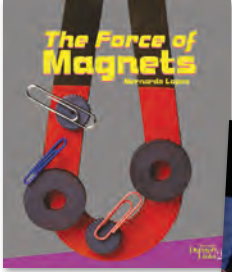
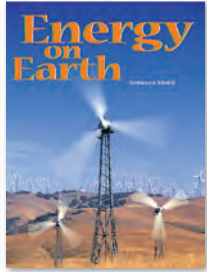
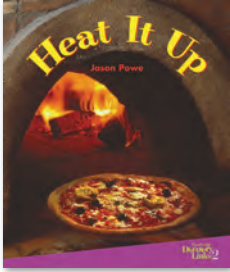

Set of 5  
**\$285<sup>95</sup>**  
 —  
 Save \$13.80

### Physics Big Books

These science big books are a perfect way to introduce science subjects to young ones. Each book has beautifully illustrated images and photographs.

NW5820K	Set of 5 Big Books	\$285.95
NW4919	Heat It Up Big Book	\$59.95
NW1326	Energy on Earth Big Book & TG	\$59.95
NW4913	Force of Magnets Big Book	\$59.95
NW5820	Simple Machines Big Book & TG	\$59.95
NW5813	Energy Big Book & TG	\$59.95

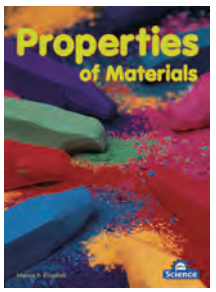

### Properties of Materials Big Book & TG

Students think and learn about what materials things are made of and why.

NW5816 Sound Book \$59.95

### World of Matter Big Book & TG

Teach your students about the properties and states of matter, show them how solids, liquids and gases can transform due to different circumstances.

NW7910 Sound Book \$59.95



Save  
**\$285**

### How Can I Experiment w Simple Machines Books

Find out how simple machines work by exploring their functions and by experimenting with them! Each book measures 20 x 20cm and has 24 pages.

RP5210K \$79.80 \$76.95

### Checker Plus pH Tester

The Checker Plus now offers automatic calibration to one or two points, automatic buffer recognition, calibrated buffer tags, stability indicator, low battery indicator, and selectable automatic shut off. The Checker Plus still maintains the iconic pentagon design with a probe that measures 103 mm in length and tapers to a 8 mm diameter making it ideal for test tubes and vials.

SER1164073

\$119.95



### Digital Light Meter

A handy digital light meter for photography, lab work, architectural, engineering and construction applications. It includes an integrated stand and will measure incident light in 3 ranges: 0.01 to 200, 200 to 2,000, 2,000 to 20,000 And 20,000 to 50,000 lux. The photo detector is wired on A curly cord which extends to 1 meter, Allowing the user to take light measurements at the optimum position.

SER1024007

\$69.95



### Basic Conductivity Meter

Visually compare conductivity between different solutions using this conductivity meter. The green LED is numbered from 1-10 and will light up as the probes are dipped into solutions of salts or acids.

SER1055024

\$44.95



### Salinity Refractometer with ATC - 28%

This salinity refractometer has the ability to measure the concentration of NaCl (salt) in water and food preparations up to 28%. Designed for testing the concentration of water and brine. Featuring a triple scale, measuring in parts per thousand. Equipped with automatic compensation for field use.

SER1148003

\$120.95

### Anemometer with Tripod

Provides wind speed, wind chill, temperature, barometric, and altitude information for any outdoor activity. The main display can be toggled between wind speed or altitude, with the sub-display showing either temperature/wind chill, or barometric pressure and temperature. The feature-packed device is small enough to fit in your pocket and can be used hands-free with the included mini tripod.

SER1068001

\$99.95



### Anemometer

This Anemometer has the ability to measure wind speed and chill. Measurements are provided in Km/h, mph, ft/min, m/s and knots. Featuring the Beaufort wind scale bar graph, wind chill, Temperature, an LCD backlight, Auto power off, Neck band and instructions.

SER1052522

\$66.95

## Soil Testing

### Backpack Lab Soil Quality Testing Kit

A complete, portable learning experience. We introduced a kit specifically assembled for the educator and Environmental Science student. Using the popular Agricultural Combination Test Kit as its foundation, the Soil Quality Education Test Kit is designed to provide a complete lesson plan for teachers.

SER1164053 \$1,199.95



### Ganong Potometer

This Ganong Potometer demonstrates transpiration rates of water absorption by a plant shoot under various external conditions.

SER1010326 \$49.95



### Agricultural Soil Test Kit

With this soil test kit you have the ability to test the soil for pH, nitrogen, phosphorus and potassium. Kit includes, 2 x 120mL extraction solution, 70mL pH indicator, 75 powder packets (25 each for N, P and K), 3 x 1mL pipettes, 5 x test tubes, test tube stand, spoon, brush, 4 x colour cards, graduated card and handbook. Measures 235 x 176 x 117 mm.

SER1164037 25 test \$169.95



### Soil pH & NPK Tablet Test Kit

This simple kit provides testing for pH, Nitrogen, Phosphorus & Potassium. Each container contains tablets to carry out 8 tests. (32 Total).

SER1009117 32 test \$39.95



### Soil Moisture Meter - 300mm Stem

This soil tester measures soil conductivity and temperature.

SER1028025 300mm Stem \$13.95



### Soil Moisture, Light & pH Meter - 300mm Stem

With this soil meter you have the ability to test pH and moisture to ensure suitable growing conditions.

SER1009113 300mm Stem \$21.95



### Soil, Fertility, pH & NPK Meter

This soil meter gives an accurate indication of whether the soil being measured is fertile or not without the need for batteries. The pH portion of the tester utilises the chemical reaction known as Oxidation-Reduction to measure pH within the range of 1 through 9. Fertility is in the range of "Too Little", "Ideal" and "Too Much".

SER1052954 \$17.95



### Student Microprocessor Controlled Colorimeter

Microprocessor controlled colorimeter, designed for student use. Colorimeters are used to measure the transmittance and absorbance of light passing through a liquid sample.

SERCH1003-001 \$499.95

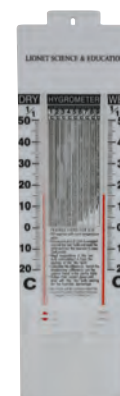

### Hanging Wet & Dry Bulb Hygrometer

Measure the amount of water vapour and humidity in the air with this hygrometer.

SER1028010 \$9.95



Pen Meters

High quality meters, from a reliable brand, at an affordable price. These Pen Meters are perfect for any lab or classroom. Including salinity meters, conductivity meters, pH meters and more!

SERST10	pH 0-14 Resolution 0.1	\$99.95
SERST20	pH/Temperature - 0-14 - 0°-99°C 0.01	\$149.95
SERST10C-A	Conductivity - 0.0 - 199.9uS/cm	\$109.95
SERST10C-B	Conductivity - 0 - 1999 x 1uS/cm	\$129.95
SERST10C-C	Conductivity - 0.00 to 19.99mS/cm	\$129.95
SERST10T-A	TDS - 0.0 - 100.0mg/L	\$109.95
SERST20S	Salinity/Temp Pen Meter - 0.0 80.0ppt 0-99c	\$169.95
SERST20R	ORP/Temperature Pen Meter - 1000mV 1000mV	\$249.95



SER1164045B	pH & Temperature Pen Meter (pH Accuracy 0.01)	\$299.95
SER1164045A	pH & Temperature Pen Meter (pH Accuracy 0.01)	\$249.95
SER5009702	pH, Conductivity, TDS, Salt & Temperature Pen Meter	\$199.95
SER1164101B	Low Range pH, Conductivity, TDS & Temperature Pen Meter	\$399.95
SER1164101A	High Range pH, Conductivity, TDS & Temperature Pen Meter	\$399.95
SER5009601	Waterproof TDS Pen Meter	\$81.95
SER5009602	Conductivity Pen Meter 0-1999 x 1uS/cm	\$73.95
SER5009900	Portable Digital Turbidity Meter	\$529.95
SER5009600	pH Pen Meter - 0-14 x 0.01	\$79.95



High Quality Bench Meter - pH 0.001

SERST5000-B \$1,499.95



Bench Meter - pH / ORP -2 16 1999mV-1999mV

SERST3100-B \$899.95



## Voltmeters & Multimeters

### Voltmeters

A Voltmeter is an instrument used for measuring the electrical potential difference between two points in an electrical circuit. Our wide range of Voltmeters includes both analogue and digital devices. In our range you will find single, double and triple range Voltmeters. MTA has all the essential Voltmeters for your classroom.

SER1040035	Digital Voltmeter 0-19.99V Range	\$69.95
SER1040007	Single Range Voltmeter AC 0-20V	\$34.95
SER1040016	Centre Read Voltmeter DC 10-0-10V	\$34.95
SER1020085	Meter Volts Triple Range DC 0-3-15-300V	\$27.95
SER1040006	Double Range Voltmeter DC 0-2-20V	\$29.95
SER1040014	Double Range Voltmeter DC 0-1-10V	\$29.95
SER1040020	Student Double Range Voltmeter AC 0-12-36V	\$29.95
SER1040013	Double Range Voltmeter DC 0-50-500Mv	\$29.95
EIS1080A	Voltmeter	\$19.95



SER1040035



SER1040007



SER1040006



EIS1080A



SER1040013



SER1040020



SER1040014

### Multimeters

Multimeters are a must have in every lab! These cool tools are able to work as a voltmeter, ammeter and as an ohmmeter, allowing you to measure voltage, current and resistance in any electrical circuit. In our range you will find both analogue and digital Multimeters. Let your students learn the basics of electricity with these easy to use Multimeters.

SER1052337A	Multimeter - Digital - Spare Probes - 930mm	\$6.95
NK0411	Digital Multimeter	\$25.95
EL1500	Digital Multimeter	\$16.95
SER1171001	Analogue Multimeter - 0.1-1000V - 19 Range	\$39.95



SER1052337A



SER1171001



EL1500



NK0411

**Ammeters**

An Ammeter is a measuring instrument used to measure the current of a circuit. Find all the high quality ammeters that MTA has to offer right here.

EIS1102B	Digital Ammeter	\$41.95
SER1040034	Digital Ammeter AC/DC, 0-19.99A	\$69.95
EIS1074	Ammeter	\$19.95
SER1040001	Single Range Ammeter DC 0/5A	\$34.95
SER1040002	Single Range Ammeter AC 0/5A	\$34.95
SER1040010	Centre Read Ammeter DC 1/0/1A	\$34.95
SER1040012	Centre Read Ammeter DC 100/0/100mA	\$34.95
SER1040029	Centre Read Ammeter DC 20/0/100uA	\$34.95
SER1020183	Centre Read Ammeter DC 500/0/500uA	\$34.95
SER1040003	Centre Read Ammeter DC 60/0/60uA	\$34.95
SER1040005	Double Range Ammeter DC 0/50/500mA	\$34.95
SER1040008	Double Range Ammeter DC 0/1/10A	\$34.95
SER1040011	Double Range Ammeter AC 0/50/500mA	\$34.95
SER1040017	Double Range Ammeter DC 0/1/5A	\$34.95
SER1020012	Digital Ammeter DC 0-199.9mA	\$34.95
SER1040004	Digital Ammeter AC/DC 0-19.99A	\$34.95



EIS1102B



EIS1074



SER1040002



SER1040029



SER1040004



SER1040011



SER1040008



SER1040003

**Dual Range Volt & Amp Meter**

A versatile, dual range Volt & Amp meter, that measures both Volts and Amps. Simply slide the selector from A to V to change between Amps and Volts. Amps: 5A / 1A / 100mA / 100uA, Volts: 50V / 10V / 1V / 100mV.

SER1052023 \$29.95



## Clinometers & Test Strips



### Clinometer with Sighter

Easily calculate the height of any tall object. Simply aim, squeeze the trigger, and view the angle of inclination. Use some simple maths and you can find the height of an object in the distance.

SER1050001

\$29.95

### Clinometer

A clinometer is an instrument used to measure the height of an object by determining the angle of the slope. This compact clinometer has been designed with no external moving parts and a combined 'sighting' - angle reading eyepiece. A window on the side of the Clinometer allows a second person to confirm or check a reading.



NK16469

14cm \$32.95

### Inclinometer

Easily calculate the height of any tall object. Simply aim, squeeze the trigger, and view the angle of inclination. Use some simple maths and you can find the height of an object in the distance.

SER1052959

\$7.95



### Invicta Clinometer

This compact clinometer has been designed with no external moving parts and a combined 'sighting' - angle reading eyepiece. A window on the side of the clinometer allows a second person to confirm or check a reading. Instruction leaflet included. It measures 14cm in diameter.

IP0506

14cm \$46.95



### Test Strips

Test strips are a super easy way of identifying if a solution contains a certain product like nitrate, glucose or even if a solution is acidic or basic using litmus paper or pH paper. Test strips are an essential for any laboratory.

SER1307003	pH Universal Test Strips 1-14	\$6.95
EIS0626B	pH Paper Cardboard Box - 100 strips	\$4.35
NK50851	pH Paper Test Strips	\$4.50
SER1038695	Test Strips - pH - 3 - 6 x 0.5 - Pack of 50	\$21.95
EIS0236K	Litmus Paper Strips	\$7.95
SER1052384	Blue Litmus Test Strips	\$3.50
EIS0623B	Blue Litmus Paper Strips - Box of 100	\$4.35
SER1052385	Red Litmus Test Strips	\$3.50
EIS0623A	Red Litmus Paper Strips - Box of 100	\$4.35
SER1014455	Cobalt Chloride Test Strips	\$16.95
SER1038912	Nitrate/Nitrite Combined Test Strips	\$42.95
SER1038962	Nitrate Test Strips - 10-25-5 -10 -250-500ppm	\$35.95
SER1166002	Glucose Urine Test Strips	\$44.95
SER1014321	Sodium Benzoate Taste Test Strips	\$5.95
SERLW3857-01	PTC Taste Test Strips	\$6.95



NK50851



EIS0623B

EIS0623A



SER1307003

SERLW3857-01



TeacherGeek is dedicated to inspiring and empowering the innovators of tomorrow. The TeacherGeek build system allows you to create almost anything mechanical. Make it your way incorporating found/recycling bin materials. Experiment and play, then revise and re-engineer. The TeacherGeek system allows for true engineering and innovation. The range consists of a combination of ready-to-go activity packs, or combine a wide variety of loose components to create your own STEAM model. TeacherGeek engages the hands and minds of students and teachers alike with a broad range of exciting and inspiring STEAM education activities and concepts. Students create unique solutions through scientific and engineering methods that are process, performance, and goal-driven. The components allow for designs which test accurately and consistently, so engineering can be driven by scientific research and method.



Includes over 15,000 components, complete with a pallet of replacement supplies!



### Makerspace Trolley – STEAM Activity Cart incl Resources

Roll it into your classroom, lab, or library for the ultimate Maker/STEM/STEAM solution. With over 40+ STEM projects and almost every TeacherGeek component ever manufactured, this cart can easily support hundreds of kids. Each cart includes a pallet of replacement supplies (way more supplies than you see in the cart, over 15,000 components in total!) and sturdy tools to create almost any project. The sign is dry erase. Suitable for grades K-12. Students will learn science and engineering concepts through experimentation, grow their understanding and evolve projects through the design & engineering process. The TeacherGeek Maker Cart provides ample opportunities for amazing true STEM projects.

TGK6682

\$9,999.99



### Easy Engineering Tool Set

The single set Includes one of each: multi cutters, reamer, pliers, tapping block, mini hammer and screwdriver. The class set includes 6 each of the multi cutters, reamer, pliers and screwdriver, and 3 each of the mini hammer and tapping blocks.

SER1823-84  
SER1823-85

Single Set – Set of 6 \$82.95  
Class Set – Set of 30 \$399.95



### Multi Cutter & Reamer

This set gives you the two most commonly used tools for assembly of TeacherGeek systems. The Multi Cutter provides a safe and simple way to cut plastic connector strips, dowels, and wood strips. The reamer changes the holes in TeacherGeek components from a press fit (where the dowel stays stuck) to a loose fit (where the dowels spin and slide).



SER1823-92  
SER1823-81  
SER1823-87

Multi Cutter & Reamer \$43.95  
Multi Cutter \$36.95  
Reamer \$12.95

Replenish your TeacherGeek Trolley with these Accessory packs.



**Screws – Pack of 100** NEW

SER1823-22 10x25mm \$13.95  
 SER1823-23 10x38mm \$17.95  
 SER1823-27 10x50mm \$19.95



**Motor Mounts – Pack of 20** NEW

SER1823-38 Large \$15.95  
 SER1823-69 Small \$9.95



**Motors – Pack of 20** NEW

The large motors are 3-6V, the small motors are 1.5-3V.  
 SER1823-70 Large \$55.95  
 SER1823-75 Small \$49.95



**Dowels – Pack of 50** NEW

SER1823-35 5x600mm \$39.95  
 SER1824-20 5x300mm \$18.95



**Mixed Gear Set – Pack of 40** NEW

SER1823-28 \$34.95



**Mixed Pulley Set – Pack of 40.** NEW

SER1823-29 \$34.95



**Connector Strips – Pack of 50** NEW

SER1823-31 300mm \$34.95



**Hole Plates – Pack of 20** NEW

SER1823-32 \$26.95

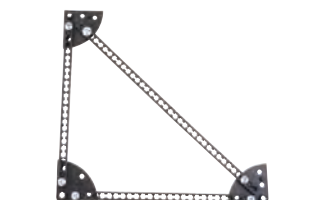

**Angle Brackets – Pack of 60** NEW

SER1823-33 \$26.95



**Perpendicular Blocks – Pack of 100** NEW

SER1823-34 \$26.95



**Birchwood – Pack of 100** NEW

SER1823-36 5 x 300mm \$47.95



**Motor Adapter Pins – Pack of 90** NEW

SER1823-37 \$15.95



**Chip Board Sheets – Pack of 50** NEW

SER1823-48 21.5 x 28cm \$19.95



**Slide Stops – Pack of 5** NEW

SER1823-49 300mm \$7.95



**Hydraulic or Pneumatic Cylinders – Pack of 40** NEW

SER1823-52 4.5ml \$72.95  
 SER1823-53 14ml \$75.95



**Barbed T-Connectors – Pack of 20** NEW

SER1823-56 3.175mm \$19.95



**Check Valves – Pack of 10** NEW

SER1823-57 3.175mm \$29.95



**1way Pinch Valves – Pack of 10** NEW

SER1823-59 3.175mm \$9.95



**Stop Clips – Pack of 100** NEW

SER1823-60 \$19.95



**Tyres Rubber Bands – Pack of 40** NEW

SER1823-64 \$26.95



### TeacherGeek - Rubber Band Racer - Advanced

Design and engineer a vehicle that is propelled by the energy stored in rubber bands. Make it go for distance, or stop with precision. Design it to go fast, or cross a difficult terrain. Rubber band racers can be easily redesigned/reconfigured, so every day you can have a different challenge. Learn by experiencing potential and kinetic energy, simple machines, friction, elasticity and ratios. Learn how friction can help, and hurt your racer.

SER1822-96 Pack of 10 \$219.95  
SER1822-95 Each \$26.95



### TeacherGeek - Wind Lift Activity

Experience the power of wind. Design and build a wind lift that can capture it. Wind lifts use energy from the wind to raise a bucket. Engineer it to lift a heavy load or raise the bucket with speed. Wind lifts make learning about wind power, energy, mechanical advantage, torque, work, and other scientific concepts fun and understandable.

SER1823-15 Pack of 10 \$89.95  
SER1823-14 Each \$13.95

### TeacherGeek - Wiggle Bot

Wiggle-Bots are motorized contraptions that are designed and built entirely by students. Watch eyes widen as wires are connected and Wiggle-Bots start to move. See how understanding and design evolves through experimentation and tinkering. Appreciate the challenge of going beyond step by step instructions and creating something completely new and innovative.

The Wiggle Bot includes a battery holder, motor with leads, gears, dowels, and motor mount. The Wiggle Bot Super includes the same resources, plus an additional hole plate, steal wire, connector strips, and screws and nuts.



SER1824-56 Super - Pack of 10 \$199.95  
SER1823-16 Super - Each \$26.95  
SER1824-57 Standard - Pack of 10 \$159.95  
SER1823-17 Standard - Each \$23.95



### TeacherGeek - Hydraulic Claw

Design and build a hydraulic claw that works like the ones in the arcade. Move the upper cylinder and watch your claw open and close below. We have documents to get you started, but the final claw design is up to you. Can you design a claw to pick up specific objects (worms, marshmallows, balls)?

SER1824-60 Pack of 10 \$139.95  
SER1824-59 Each \$17.95

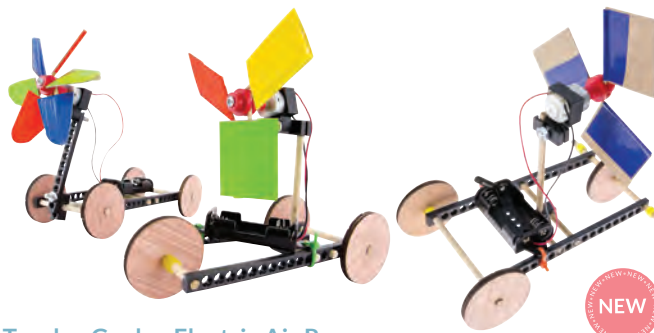
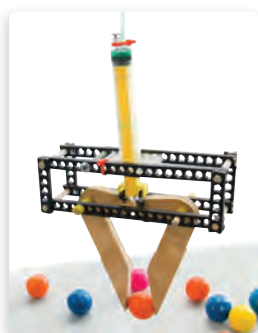

### TeacherGeek - Electric Air Racer

Send this racer flying with an electric motor and propeller. Design it for speed by designing the frame and propeller blades. This activity requires materials from the recycling bin to create the propeller blades. Learn about electricity, blade angle, and propeller design, apply the scientific method and innovate (design, build and evolve your own unique design).

SER1824-66 Pack of 10 \$129.95  
SER1824-76 Each \$17.95



### TeacherGeek – Land Sail Car

Design and engineer a vehicle that is propelled by the wind. This activity is perfect for early elementary groups. It allows students to quickly and easily experiment with sail shape, angle, and placement. Engineer a Sail Car that can go the greatest distance, travel the fastest, or carry the most weight. Learn about forces and motion by completing the optional Sail Car labs.

SER1824-67  
SER1824-77

Pack of 10 \$99.95  
Each \$16.95

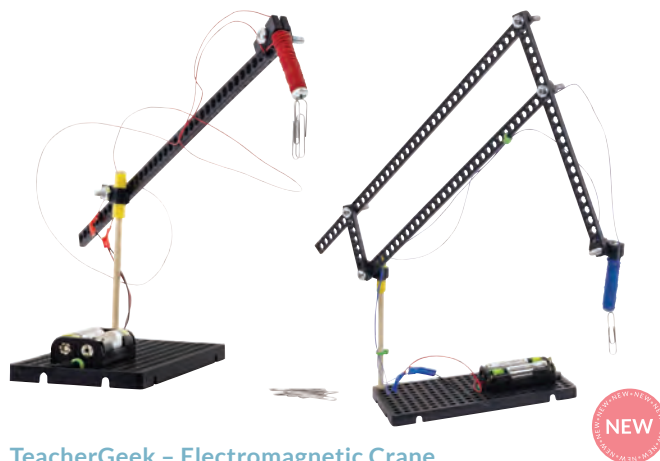

### TeacherGeek – Electromagnetic Crane

Design and build a crane that can best sort magnetic materials for recycling. Start by making and experimenting with an electromagnet, then create a crane to move it. Test the crane using the scientific method. Evolve the crane through the engineering design process.

SER1824-61  
SER1824-71

Pack of 10 \$119.95  
Each \$17.95



### TeacherGeek – Advanced Ping Pong Projectile Launcher

Build your own Projectile Launcher with TeacherGeek – send ping pong balls flying, marking the trajectory and distance of your shots and targets. Redesign your launcher with greater accuracy and precision through the optional labs and graphing sheets, then compete in exciting design challenges.

SER1823-05  
SER1823-04

Pack of 10 \$169.95  
Each \$21.95



### TeacherGeek – “Catch The Bug” The Ultimate Electronics Activity

The bug is a truly fantastic and meaningful electronics learning activity. Finished bugs run around the floor with their own personality. Bugs teach basic electronics through a physical interactive experience; an experience that yields deep and long lasting understanding.

SER1822-87  
SER1822-86

Pack of 10 \$199.95  
Each \$29.95



### TeacherGeek – Build A Boat Activity

Use common materials to explore buoyancy and power! Design a working electric motor boat with this activity. Find your hull in the recycling bin (milk jug, foam tray, pool noodles, etc.). Add the motor, propeller and other components. Set it in the water and watch it go.

SER1822-99  
SER1822-98

Pack of 10 \$149.95  
Each \$19.95



### TeacherGeek – Wind Pump Activity

The Wind Pump harnesses the energy created from wind to pump water. The wind-driven turbine powers a geared transmission that operates a hydraulic pump. This will move water from one level up to another. You will apply many scientific concepts such as calculating work, fluid mechanics, simple machines and aerodynamics. A stand is necessary and not included.

SER1823-19  
SER1823-18

Pack of 10 \$399.95  
Each \$53.95





At 3DuxDesign, we realise innovation is not only about maths and science but also art, design, the environment and people. We encourage students to imaginatively and practically think through solutions to real world problems by building structures and environments. A combination of connectors and geometric cardboard forms let students build anything they can imagine. The connectors are engineered to fit most cardboard so almost any shipping box can be transformed into building material. Suitable for students from the age of 4 and up.

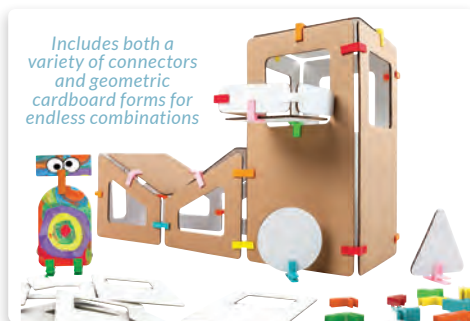

### Why 3DuxDesign?

- Promoting STEAM education and real-world problem solving by offering an engaging product that blends science, maths, technology, engineering, art and creativity
- By incorporating sustainable and repurposed materials, 3DuxDesigns is an environmentally friendly construction set
- Perfect for schools, makerspaces, after-school STEM/STEAM programs and inventor clubs
- Includes a wide variety of freely accessible lesson plans and open-ended design challenges
- Use the high-quality 3DuxDesign geometric cardboard pieces, or use any of your spare cardboard boxes

### 3Dux – The Educational GOBOX including Cardboard

This specialty kit for educators comes with 400 assorted connectors, over 500 geometric cardboard forms, a full set of architectural rulers and the perfect storage case. Give your students' creativity a jumpstart and introduce your them to geometry and 3D spatial thinking. Add your own recycled cardboard for endless options.

DX002

\$299.95

Environmentally friendly construction sets



### 3Dux – The GOBOX PRO – LED Lights

The Gobox Pro is the perfect product to engage students ages 6+ in learning about architecture, engineering and electricity. The lesson plan walks students through building and electrifying their very own models. Then reuse materials to light up all of your cardboard creations.

This kit includes:

- 400 assorted connectors
- Over 500 geometric cardboard shapes
- A full set of architectural rulers
- 10 LED lighting sets (each with 4 coloured LED bulbs, 2 alligator clips, 1 foot conductive tape, 1 battery holder, 1 toy dog)
- The perfect storage case

DX003

\$369.95

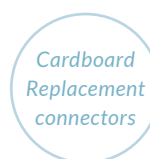

### 3Dux – Connector Kits

DX001

Set of 60 \$44.95

### 3Dux – Cardboard Refill for Classroom

DX004



Over 500 pieces \$79.95

## The Cool Tool

### Wood Working

### The Cool Tool Education

The Cool Tool offers a range of modular, innovative machines for model making, design and engineering, and prototyping. The woodworking machines are an ideal resource for STEAM projects and are great for makerspaces. From the fully operating workshop 'Playmat' suitable for students aged 4 and up, all the way to perfectly aligned 'Metal Line' for precision artworks, the Cool Tool offers machinery for early primary to end of high schools.

### Playmat – 4in1 Woodworking Workshop

The Playmat – 4in1 Woodworking Workshop encourage creativity and technical understanding. The Playmat kit contains all the necessary parts for building up to 4 different, real working machines which can easily be assembled due to the well-designed component pieces and easy connection system. A special child-proof adaptor is included, to make this set suitable for ages 4 and up.

TCT9012

\$199.95

*The child-friendly design makes Playmat suitable for students from the age of 4 and up!*

#### Includes

- Machine bed (280mm)
- Tailstock
- Drive Unit
- Drill, Drilling & Sanding Table
- Sanding Disk
- Tool Res
- 12V Safety adaptor
- Screw Driver
- Gouge
- Detailed instructions plans & suggestion
- Wood for turning and sawing to start instantly.

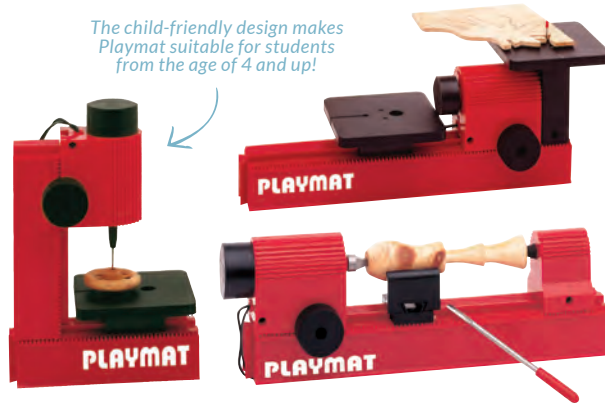

#### Build 4 real working woodworking machines:

- Drill-press
- Wood lathe
- Jigsaw
- Sanding machine

### Unimat 1 Elementary Kit – Woodworking

Unimat 1 is ideal to introduce students into the world of machine tools and woodworking. The machines have the same features as big industrial machines, the only differences are their size and the 12V drive. The Unimat 1 is fully modular and easy to set up. Included in the kit are the components for a jigsaw, variations of woodturning machines, a handheld and stationary sander and a handheld drilling machine.

This kit includes all the parts needed to build these machines:

- Wood turning lathe
- Jig saw
- Sanding machine
- Hand drill or sander

TCT1601

\$599.95



#### Assorted Wooden Dowels incl Centerhole

A set of 24 wooden dowels to use with you're the Cool Tool machinery. The pieces are made of Lime wood and include 17 pieces of 2cm in diameter and 7 pieces of 3cm in diameter. With centre hole.

TCT3120

\$29.95

### Unimat ML – Design & Technology Kit

The Metal Line design is ideal for intensive usage in the classroom, and adds precision and perfect alignment. Included in the kit are the components for a jigsaw, for variations of wood turning machines (incl 3-jaw chuck), for a hand-held sander or a stationary sander and for a hand-held drilling machine. STEM activities support and strengthen the learning dispositions.

This kit includes all the parts needed to build these machines:

- Wood turning lathe
- Jig saw
- Sanding machine
- Hand drill or sander

TCT6015

\$999.95

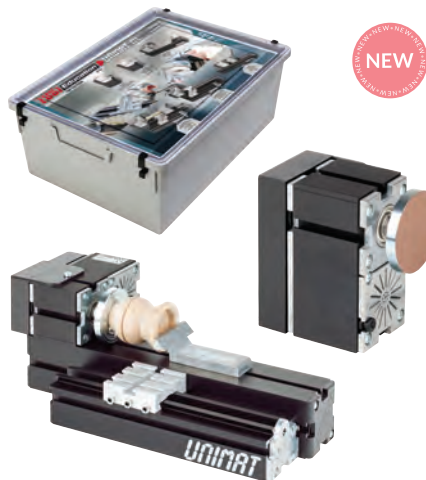

#### Balsa Wood – Assorted Pieces

"A collection of varied sizes of balsa wood. This kit includes glue so students get started with their projects right away! Students can use these for construction in the classroom or art projects.

Pack Includes:

- 3 of 1.5 x 100 x 450mm
- 3 of 3.0 x 75 x 450mm
- 2 of 5.0 x 75 x 450mm
- 4 of 9.5 x 450mm Squares
- 1 Tube of Glue"

DC51629

\$20.95



## Grove

Grove is a modulated, ready-to-use tool set. It takes a building block approach to assembling electronics. Compared with the traditional, complicated learning method of using breadboards and various electronic components to assemble a project, Grove simplifies this learning process significantly. The Grove System consists of a base shield and a wide variety of input and output modules. Simply connect the grove modules via the base shield to a microprocessors such as micro:bit or Arduino for endless coding and science projects.

Powered	Programming Language/Software	Operating Systems	Age Group Years 7+
	(GRV6024 & GRV6130)  (GRV0762)		

### Why Grove?

- Uniform Interface, plug-and-play, no soldering required
- Perfect for prototyping, without the need for soldering or complex wiring
- Detailed documentation, electronics background is not required
- Various function modules including display, motion detect, communication, environment, and robot
- Grove is now compatible with most development platforms including Arduino, Raspberry Pi, micro:bit and more!

\$1,414.45  
**\$1,159<sup>95</sup>**  
Save \$254.50

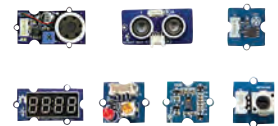

### Kit includes

- Grove Shield for Micro:bit
- Grove Rotary Angle Sensor
- Grove Speaker
- Grove Ultrasonic Ranger
- Grove Light Sensor v1.2
- Grove WS2812 Waterproof LED Strip - 30 LEDs 1 meter
- Grove Gesture
- Grove 4-Digit Display
- Grove Red LED
- Micro USB Cable - 48cm
- 12 Projects Manual
- Alligator Cable
- Grove Cable

### Grove Inventor Kit for micro:bit

The Grove Inventor kit for micro:bit brings endless possibilities to your micro:bit. The Grove shield for micro:bit makes it easy to connect your micro:bit to all of the grove components, including sensors, displays and actuators. Please note: micro: bit is not included in GRV0762, but is included in GRV0762K and GRV0762-10K.

GRV0762	Inventor Kit	\$109.95
GRV0762K	Inventor Kit & micro:bit	\$116.95
GRV0762-10K	10 Inventor Kits & 10 micro:bit	\$1,159.95



### Grove - Starter Kit for Arduino

This Grove - Starter Kit for Arduino is a perfect starter kit for Arduino beginners. It includes a Base Shield which has many Grove connectors on board, twelve Grove modules that covers most functions needed by a beginner and a very helpful user manual that can help you get started quickly. Please note: this kit does not include Arduino, which is required to use the kit.

GRV6024 \$79.90

- Kit includes**
- Buzzer
  - Base Shield
  - LCD RGB Backlight
  - Smart Relay
  - Temperature Sensor
  - LED
  - Light Sensor
  - Button
  - DIP LED Blue-Blue
  - DIP LED Green-Green
  - DIP LED Red-Red
  - Mini Servo



### Grove Smart Plant Care Kit For Arduino

To keep the indoor plants alive and robust is not an easy task. Plants are like people, they need nutritious soil, right temperature, adequate sunshine and water. Many electronics beginners who are getting started with Arduino and love planting would start their first project of making a plant growing system. Here we provide one-stop solution to build up your own plant care system. Please note: this kit does not include Arduino, which is required to use the kit.

GRV6130 \$119.95

- Kit includes**
- Base shield
  - Temperature & Humidity Sensor
  - Moisture Sensor
  - Sunlight Sensor
  - OLED Display 0.96"
  - Encoder
  - Button
  - Relay
  - Water Flow Sensor
  - 12V Water Pump

## Grove

**Grove – Essential Modules Add-On Kit**

NEW

The Grove Essential Modules Add-On kit includes the most commonly input and output sensors and modules to add to any project. Also included is a base shield for micro:bit and cables in two lengths. The kit requires a micro:bit. Available with or without micro:bit. For more information about the individual modules, please refer to our website.

GRV1123K Kit without micro:bit \$69.95  
 GRV1123K-M Kit with micro:bit \$104.95

**Kit includes**

GRV1132 Grove Light Sensor v1.2 \$5.95  
 GRV1123 Grove Button \$3.95  
 GRV1435 Grove Red LED \$3.95  
 GRV1720 Grove Buzzer \$3.95  
 GRV1439 Grove White LED \$3.95  
 GRV1223 Grove Sound Sensor \$9.95  
 GRV1237 Grove Touch Sensor \$7.95  
 GRV1363 Grove Shield for micro:bit v2.0 \$21.95  
 GRV4310 Grove Blue LED \$3.95  
 GRV9938 Grove Universal 4 Pin Buckled 50cm Cable (5 PCs Pack) \$7.95  
 GRV9927 Grove Universal 4 Pin Buckled 20cm Cable (5 PCs pack) \$5.95



NEW

**Grove – Environmental Science Modules Kit**

The Grove Environmental Science Modules Kit is the perfect combination of modules to combine environmental science topics with coding with micro:bit. Analyse temperature, humidity, moisture levels, sound, water and more, and display the values on the 4-digit display included. The kit requires a micro:bit. Available with or without micro:bit. For more information about the individual modules, please refer to our website.

GRV1211K Kit without micro:bit \$162.95  
 GRV1211K-M Kit with micro:bit \$189.95

**Kit includes**

GRV1211 Grove Temp & Humi Sensor \$11.95  
 GRV1128 Grove Moisture Sensor \$6.95  
 GRV1215 Grove Temperature Sensor \$5.95  
 GRV1223 Grove Sound Sensor \$9.95  
 GRV1433 Grove 4-Digit Display \$11.95  
 GRV1218 Grove Water Sensor \$5.95  
 GRV1363 Grove Shield for micro:bit v2.0 \$21.95  
 GRV1278 Grove Air quality sensor v1.3 \$19.95  
 GRV2012 Grove Dust Sensor \$21.95  
 GRV2193 Grove Barometer Sensor \$39.95  
 GRV9938 Grove Universal 4 Pin Buckled 50cm Cable (5 PCs Pack) \$7.95  
 GRV9927 Grove Universal 4 Pin Buckled 20cm Cable (5 PCs pack) \$5.95



NEW

**Grove – Physics Modules Kit**

The Grove Physics Modules Kit allows you to perform physics activities and experiment with topics like forces and motion, light and sounds, vibration and much more. The kit requires the use of micro:bit. Kit is available with or without micro:bit included. For more information about the individual modules, please refer to our website.

GRV1121K Kit without micro:bit \$179.95  
 GRV1121K-M Kit with micro:bit \$219.95

**Kit includes**

GRV1223 Grove Sound Sensor \$9.95  
 GRV1523 Grove – Vibration Motor \$5.95  
 GRV1132 Grove – Light Sensor v1.2 \$5.95  
 GRV1122 Grove – PIR Motion Sensor \$15.95  
 GRV1121 Grove Ultrasonic Distance Sensor \$7.95  
 GRV0553 Grove – Round Force Sensor \$24.95  
 GRV0054 Grove 3-Axis Digital Accelerometer \$18.95  
 GRV0005 Grove – Servo Motor \$11.95  
 GRV0111 Grove 16x2 LCD – White on Blue \$11.95  
 GRV2005 Grove – Relay \$5.95  
 GRV1720 Grove – Buzzer \$3.95  
 GRV0587 Grove – Optical Rotary Encoder \$17.95  
 GRV1237 Grove – Touch Sensor \$7.95  
 GRV1363 Grove Shield for micro:bit v2.0 \$21.95  
 GRV0103 Grove – I2C Motor Driver \$12.95  
 GRV9938 Grove Universal 4 Pin Buckled 50cm Cable (5 PCs Pack) \$7.95  
 GRV9927 Grove Universal 4 Pin Buckled 20cm Cable (5 PCs pack) \$5.95



## Boson

Boson is a set of modular electronic building blocks designed for young inventors and STEAM teachers, to provide a visual way to make math and science subjects fun in the classroom. The colour-coded modules make it easy to identify input and output modules. Boson can be used completely coding-free, or use it with the Expansion board for micro:bit to program the modules. With sensors, actuators, logic gates and more, there are infinite possibilities for endless learning.

<p>Powered</p>	<p>Programming Language/Software</p> <p>code-free or with</p>	<p>Operating Systems</p>	<p>Age Group Years 4+</p>
----------------	---	--------------------------	-----------------------------------

### Why Boson?

- Plug and play – Boson modules are connected through flexible cables, requiring no soldering
- Hook up to everything: Boson modules are magnetic. Stick them on a whiteboard or other magnetic objects, or screw them onto something with the mounting plates. LEGO compatible.
- Tutorials and lesson plans are available.
- Start with Boson free of coding, or upgrade to platforms such as micro:bit to make Boson programmable
- Digitalised scientific exploration – the Boson platform includes a series of industrial standard sensors, for entry level scientific experiments, unattended environmental monitoring or upload data to an IoT server

### Boson Starter Kit for micro:bit

Build your own programmable project with micro:bit! The Starter Kit for micro:bit comes with 8 modules and 4 quick start project cards, plus a 12-project tutorial from beginner to advanced. The micro:bit expansion board is used to hook up the Boson modules to micro:bit.

**DFR086** Starter Kit \$109.95  
**DFR086K** Starter Kit & micro:bit \$129.95

#### Kit includes

- 1x micro:bit expansion board for Boson kit
- 1x Red Push Button
- 1x Red LED Light
- 1x Rotation sensor
- 1x Sound Sensor
- 1x Motion sensor
- 1x Mini Fan Module
- 1x Mini Servo
- 1x RGB LED strip
- 1x Micro USB Cable
- 1x 3-Pin Cable (Long)
- 1x 3-Pin Cable (Medium)
- 1x 3-Pin Cable (Short)
- 1x Quick Start Guide



\$135.90  
**\$129.95**  
 Save \$5.95

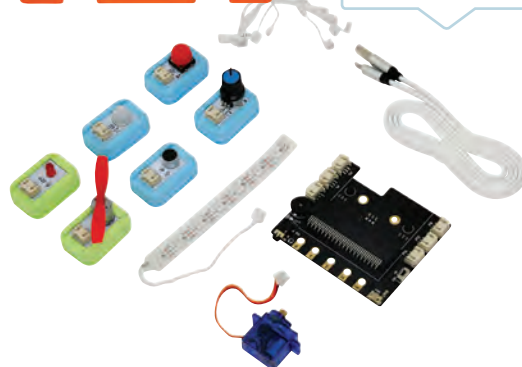

### Boson – Expansion Board for micro:bit

The expansion board for micro:bit allows you to hook up all your Boson modules to micro:bit. This makes your Boson modules programmable! micro:bit is not included and sold separately.

**DFR521** \$19.95



Use Boson with micro:bit



50+ colour coded electronic modules for infinite possibilities

Tutorials & course materials for both learners & educators

Attachable to Lego blocks, Velcro pads, screws & whiteboards

Digitized scientific exploration

Start with coding free; upgradable to micro:bit & Arduino.

Plug & play design with unifying safe & secure connection



### Boson Science Kit

The Boson Science Kit includes 8 scientific sensors that are most widely used in modern IoT applications, for physics, chemistry and biology. It includes activity cards to start your scientific exploration on 8 different topics. The plug and play monitor shows instant results and measurements.

**DFR034** Set of 8 \$229.95

## Boson

### Boson – Environmental Science Kit

This kit includes a range of Boson modules to experiment with science activities. Included in the kit (DFR011K) is one of each: expansion board for micro:bit, temperature sensor, pH sensor, light sensor, soil moisture sensor, humidity sensor, waterproof sensor, OLED module, red, green and blue LED module, cable pack (pack of 30) and a battery holder. The kit is also available with a micro:bit included (DFR011K-M).

**DFR011K** Kit without micro:bit \$299.95  
**DFR011K-M** Kit with micro:bit \$309.95

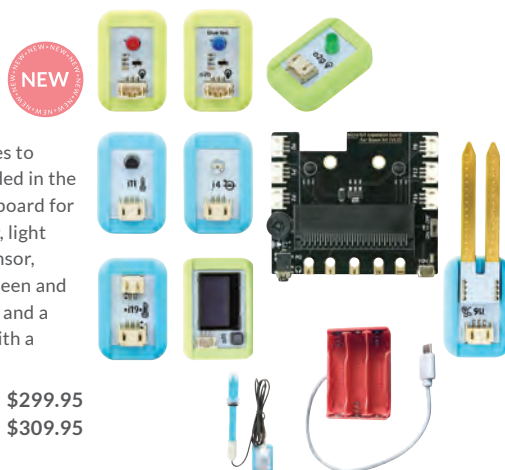

#### Kit includes one of each:

DFR011	Temperature Sensor – Input	\$19.95
DFR039	pH Sensor – Input	\$99.95
DFR004	Light Sensor – Input	\$10.95
DFR038	Soil Moisture Sensor – Input	\$10.95
DFR041	Humidity Sensor – Input	\$26.95
DFR042	Waterproof Sensor – Input	\$16.50
DFR044	OLED Module – Output	\$55.95
DFR017-R	Red LED Module – Output	\$10.95
DFR017-G	Green LED Module – Output	\$10.95
DFR017-B	Blue LED Module – Output	\$10.95
DFR521	Expansion Board for Microbit	\$19.95
DFR525	Cable Pack	\$16.95
DFR529	3x AA Battery Holder	\$9.95

### Boson – Essential Input & Output Modules Kit

This kit includes the most popular Boson modules, which can be used on their own or as an add-on set to your existing Boson range. The kit (DFR002K) includes one of each: expansion board for micro:bit, blue, red and yellow push buttons, self locking switch, buzzer, fan, voice recorder, motor, servo motor, multicolour string light, cable pack of 30 and a battery holder. Also available with a micro:bit included (DFR002K-M).

**DFR002K** Kit without micro:bit \$189.95  
**DFR002K-M** Kit with micro:bit \$219.95



#### Kit includes one of each:

DFR002-B	Blue Push Button – Input	\$10.95
DFR002-R	Red Push Button – Input	\$10.95
DFR002-Y	Yellow Push Button – Input	\$10.95
DFR003	Self Locking Switch – Input	\$10.95
DFR020	Buzzer Module – Output	\$10.95
DFR021	Fan Module – Output	\$16.50
DFR022	Voice Recorder Module – Output	\$19.95
DFR024	Motor Module – Output	\$19.95
DFR025	Servo Module – Output	\$21.95
DFR019	Multicolour String Light – Output	\$26.95
DFR521	Expansion Board for Microbit	\$19.95
DFR525	Cable Pack	\$16.95
DFR529	3x AA Battery Holder	\$9.95

### Boson – Science Modules Kit

Perform science and physics activities with this Boson kit. The kit (DFR001K) includes one of each: expansion board for micro:bit, rotation sensor, tilt sensor, touch sensor, sound sensor, infrared proximity sensor, conductivity sensor, motion sensor, heart rate monitor, ultrasonic sensor, bright LED light, cable pack of 30 and a battery holder. Also available with a micro:bit included (DFR001K-M).

**DFR001K** Kit without micro:bit \$239.95  
**DFR001K-M** Kit with micro:bit \$249.95



#### Kit includes one of each:

DFR001	Rotation Sensor – Input	\$10.95
DFR005	Tilt Sensor – Input	\$10.95
DFR008	Touch Sensor – Input	\$10.95
DFR009	Sound Sensor – Input	\$10.95
DFR010	Infrared Proximity Sensor – Input	\$19.95
DFR012	Conductivity Sensor – Input	\$10.95
DFR013	Motion Sensor – Input	\$24.95
DFR043	Heart Rate Monitor Sensor – Input	\$43.95
DFR045	Ultrasonic Sensor – Input	\$59.95
DFR016	Bright Light LED – Output	\$10.95
DFR521	Expansion Board for Microbit	\$19.95
DFR525	Cable Pack	\$16.95
DFR529	3x AA Battery Holder	\$9.95



## Makey Makey

Makey Makey is the ultimate STEAM invention kit that works through opening and closing circuits.

Turn everyday objects into touchpads and combine them with the Internet.

Connect the circuit board via alligator clips to anything and everything that conducts electricity to create a circuit. Connect the circuit board to your laptop or PC and let the connected conductive materials take over your computer!

Connection



Age Group  
**Years 3-8**

### Why Makey Makey?

- No software or prior programming knowledge required. Just plug, clip, play, invent. Works with Mac and Windows
- Connect the world around you to your computer! Setup takes just seconds.
- 1000s of possibilities! Find endless lesson plan ideas, project ideas and inspiration online
- Works with any material that can conduct at least a tiny bit of electricity

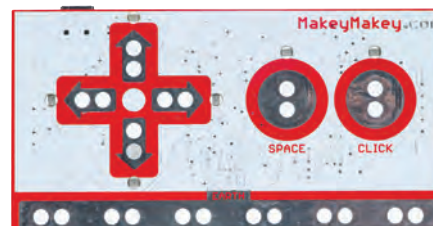

### Makey Makey Classic

Each kit includes the Makey Makey Board, USB Cable, 7 Alligator Clips, 6 Connector Wires, Instructions with Visual Project Start Guide, Online Documentation, and 20 Colour Stickers. Connects via USB (Not compatible with iPads or tablets).

MKK001	Each	\$69.95
MKK001-5	Set of 5	\$339.95
MKK001-10	Set of 10	\$679.95

Turn bananas into piano keys with Makey Makey!

Set of 10  
**\$679<sup>95</sup>**  
—  
Save **\$19.55**

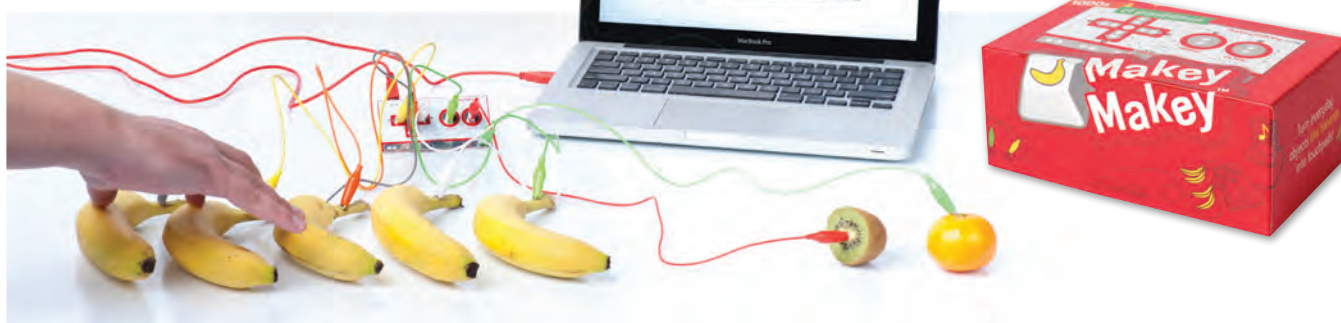

### Makey Makey STEM Pack

#### - Classroom Invent Kit

Perfect for classrooms, schools, districts, workshop teachers, and anyone else that wants all their Makey Makes in a really nicely organised briefcase. The Makey Makey STEM Kit is a distillation of 12 Makey Makes, 12 booster packs and some extra parts for when you want to invent something even bigger. Contents:

- 12 Makey Makey Classics
- 12 Alligator Clips
- 12 Connector Wires
- 72 Extra Alligator Clips
- 144 Connector Wires (for the back)
- 12 Makey Makey-Optimised Conductive 6B Pencils

MKK003		<b>\$1,199.95</b>
--------	--	-------------------



Perfect for classrooms, workshops and Makerspaces!

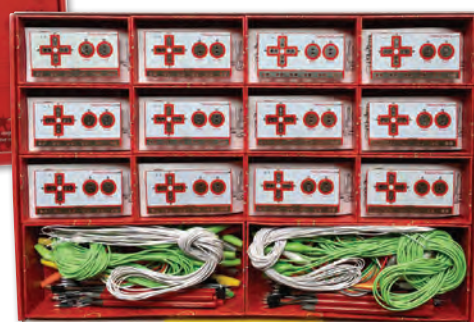











## Arduino Education



### Arduino Education

Arduino Education is focused on developing the next generation of STEAM systems and supporting the needs of educators and students throughout the educational journey. Arduino Edu has developed classroom kits suitable for end of primary and high schools, with learning paths for individual and collaborative educational approaches. Whether you are new to electronics and want to introduce physical computing and computational thinking to your classroom, or a university professor skilled in electronics, Arduino has a suitable kit for you.

Powered	Connection	Programming Language/Software	Operating Systems	Age Group
 		Code-free (ARD0014) or  (ARD0076 & ARD0101)	     	

### Why Arduino Education?

- Arduino Education is on a mission to make technology accessible to everyone, and into the hands of every student and educator.
- Arduino Education is focused on creating the next generation of STEAM programs – integrating Science, Technology, Engineering, Arts and Maths – while supporting the needs of teachers and students throughout the educational journey.
- Arduino Education offers solutions for the classroom, kits, bundles, and boards with learning paths for individual and collaborative educational approaches.
- Learners explore Arduino Education in a hands-on, constructive way as they work through the kits and explore the creative capabilities of each board.

### Arduino Edu – Starter Kit – Classroom Pack

NEW

The Arduino Starter Kit Classroom Pack is a bundled solution, containing six of the popular Arduino Starter Kits. Suitable for least twelve students for middle school onwards. Each kit contains an Arduino Uno Rev 3 board, a collection of sensors and actuators, and a guide book which will help students and teachers to take their first steps into the world of electronics, with interactive and sensing objects. Please refer to our website for a full list of components included in each kit.

ARD0076

\$849.95

#### Key Features:

- Learn the fundamentals of programming and electronics
- Introduction to sensors and actuators
- Understanding digital and analogue signals
- Critical thinking, collaborative learning and problem solving

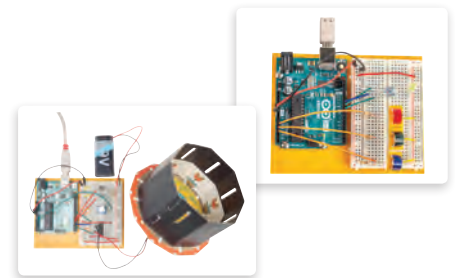

### Arduino Edu – CTC 101

This modular STEAM program consists of a toolbox with over 25 cross-curricular projects and experiments, an online platform, and guided educators support.

The 5 themed modules introduce students to programming and coding, serial and wireless communication, robotics, power systems, motors, actuators, analogue and digital systems, and advanced sensors. It covers technology, maths and physics, but educators are also encouraged to apply art, woodwork, sewing, civics, language arts, etc.

ARD0101

\$3,299.95

#### Key Features:

- Includes all components needed for a class of 30 students
- Receive access to the online platform for 2 consecutive years, including training, webinars and online community
- Learn about the fundamentals of programming and electronics



### Arduino Edu – Science Kit Physics Lab

This kit is developed for scientific exploration for students in years 6-8. Developed in partnership with Google, it is an Arduino-based physics lab, fully compatible with Google Science Journal available on Android. The kit features a range of sensors to measure light, temperature, motion, magnetic fields and full access to online course content for teachers and students.

ARD0014

\$299.95

#### Key Features:

- Experiment with electromagnetism and thermodynamics, kinetics and kinematics, forces, motion, magnetism, and conductivity
- Includes exclusive access to online educational materials
- Includes Arduino MKR WiFi 1010 and a wide range of sensors





## Circuit Scribe

Let your creativity merge with science as you build exciting circuits using our Circuit Scribe Kit's conductive ink pen, magnetic modules, and plain old printer paper. By placing the paper over a steel sheet, included in every kit, your paper becomes the base for blinking lights, beeping buzzers, and whirling motors. Everything you need to create dynamic and fun paper circuits. Find the exact contents of each kit on our website.

Powered 	Age Group <b>Years 3+</b>
-------------	------------------------------

### Why Circuit Scribe?

- Draw circuits instantly with a conductive ink pen that dries instantly
- Build simple circuits or complicated devices from basic switches to your own pen on paper machines
- Educator friendly kits teach circuitry concepts from current flow to digital logic
- Use your skills to make anything from interactive art to interactive paper devices while having fun

### Circuit Scribe Ultimate Kit – 16 Modules & 10 Connecting Cables

Everything you need to create dynamic and fun paper circuits. The kit features 10 magnetic connection cables that let you hook up your paper circuits to programmable platforms like Arduino (not included). The kit includes everything from our Maker Kit plus extra LEDs, two DPDT switches, and a motor (see our website for full list). With the Ultimate Kit, you can make complex, robust circuits.

CSR003 \$179.95



## Squishy Circuits

Squishy Circuits uses conductive and insulating play dough to teach the basics of electrical circuits, a perfect blend of play and learning! Our play dough kits, projects, and recipes teach problem solving and engineering concepts and inspire creativity and independent thinking.

Powered 	Age Group <b>Years K-5</b>
-------------	-------------------------------

### Why Squishy Circuits?

- Squishy Circuits are a design tool that allows everyone, from young students through to adults, to create circuits and explore electronics using play dough
- A perfect combination of science, technology, art and design
- Squishy Circuits makes learning about electricity and circuits accessible, and adding on to or expanding your sets can be done with easily available components

### Squishy Circuit Standard Kit

The standard kit includes everything you need to get started with some more advanced Squishy Circuits projects that use LEDs, buzzers, and insulating dough! Contents:

- 1 x Battery Holder
- 1 x Piezoelectric Buzzer
- 25 x LEDs (5 each of Red, Green, White, Yellow, Blue)
- 1 x 3.5oz Container of Insulating Dough
- 3 x 3.5oz Containers of Conductive Dough (in Red, Green, and Blue)

EL9350 \$69.95



### Squishy Circuit Standard Kit

The deluxe kit is our most complete Squishy Circuits kit. It comes with more items than the standard kit and comes with pre-made doughs so you can start circuit building right away! This kit also includes a deluxe battery holder, which has a knob that allows your lights to blink and buzzers to beep at different speeds. Contents:

- |  |   |
|--|---|
| - 1 x Deluxe Battery Holder  | - 1 x Set of Dough Sculpting Tools  |
| - 1 x Piezoelectric Buzzer   | - 1 x Rolling Pin   |
| - 1 x Motor with Fan   | - 1 x 7-Ounce Container of White Insulating Dough   |
| - 1 x Mechanical Buzzer  | - 7 x 7-Ounce Containers of Conductive Dough (in Red, Blue, and Green, Yellow, Orange, Purple, and Black) |
| - 1 x Switch   |   |
| - 40 x LEDs (5 each of Red, Green, White, Yellow, Blue, Purple, Orange, and Colour Changing) |   |

EL9352 \$149.95



Storage & Furniture

\$865.05  
**\$749<sup>95</sup>**  
 Save \$115.10



**STEM Storage Trolley & Trays**

A practical STEM storage unit. Includes 12 x 2.5 litre trays, 4 x 6 litre trays and 2 x 12 litre trays. Made from a durable metal frame and features easy rolling castors. Frame measures 46(W) x 66(D) x 120(H)cm. Contents may vary.

FFP101K \$749.95



Save  
**\$37<sup>75</sup>**



**Natural Spaces - Makerspace & STEAM Trolley**

A versatile STEAM and MakerSpace storage unit for the classroom. Features a blackboard header, removable whiteboard and blackboard, hanging hooks and lots of shelving. Kit also includes 4 x Shallow Trays, (SUN832S) and 1 x Deep Tray (SUN831L). Includes castors and measures 100(W) x 45(D) x 130(H)cm. Contents may vary.

DM12100K ~~\$657.70~~ \$619.95



Save  
**\$53<sup>40</sup>**



**ERGERITE**

**Ergerite - STEM & Robotics Standing Table & Trays**

Perfect for STEM and robotics. Table is a whiteboard and features a metal frame. Also includes lockable castors and storage on one end. Measures 120(W) x 80(D) x 97(H)cm. Kit includes 8 x small trays (SUN832S) and 4 x large trays (SUN831L). Always lift the trays when inserting or removing from the frame. Contents may vary.

HS12497K 97cm ~~\$603.35~~ \$549.95



Save  
**\$114<sup>25</sup>**



**Gratnells - Makerspace Trolley & Trays**

This mobile trolley is excellent for STEAM and Makerspaces. Features tool hangers, plastic tubs and durable castors. Measures 102(W) x 43.5(D) x 156.5(H)cm. Kit includes Gratnells Makerspace Trolley Frame, 12 x Shallow Clear Trays (NK70300) and 3 x Deep Clear Trays (NK70301). Contents may vary.

GT1144K ~~\$1,514.20~~ \$1,399.95



Set of 3  
 Save  
**\$149<sup>90</sup>**



**STEM & Makerspace**

A versatile and functional STEM and Makerspace storage kit. Includes Trolley (HSP922), Racking Storage (HSP8085) and Trolley Cart (HSP663). Contents may vary.

HSP663K Set of 3 \$999.95



HSP663



HSP922



HSP8085

**STEM & Makerspace Trolley Cart**

A mobile trolley that features adjustable internal dividers. Includes 4 swivel castors (2 x lockable), aluminium frame and 3 x shelves. Each shelf measures 59.5(W) x 49(D) x 7(H)cm. Trolley measures 66(W) x 49(D) x 92(H)cm.

HSP663 \$199.95

**STEM & Makerspace Trolley**

This aluminium and steel trolley is excellent for storing all your Makerspace and STEM tools. It features 2 drawers, 4 swivel castors (2 x lockable), hanging back panel storage and a bottom shelf. Measures 85(W) x 48(D) x 124.5(H)cm.

HSP922 \$599.95

**Racking Storage 5 Shelf**

An open-design shelving unit featuring an aluminium frame, reinforced plastic shelves and fixed metal feet. Excellent for storing boxes and tubs. Measures 68(W) x 45(D) x 113(H)cm.

HSP8085 \$349.95

~~\$643.45~~  
**\$549<sup>95</sup>**  
 Save \$93.50



**Makerspace Building Kit**

Engineer, create, build and improve structures, models and building. Use plastic, wood, or other base materials and use the tools included to put together impressive ideas.

MS900K \$549.95

~~\$821.15~~  
**\$649<sup>95</sup>**  
 Save \$171.20



**Makerspace Tool Kit**

The ultimate Makerspace Tool to have all hardware tools on hand for the biggest projects. A wide variety of tools ensures you to create any STEAM project.

MS200K \$649.95

~~\$390.80~~  
**\$349<sup>95</sup>**  
 Save \$40.85



**Makerspace Craft Pack**

A perfect Makerspace Craft Pack to ensure not one project is too big! This pack includes a variety of materials to put the 'A' (art) in STEM. Construct models and decorate with these resources.

MS300K \$349.95

~~\$219.75~~  
**\$208<sup>95</sup>**  
 Save \$10.80



**Makerspace Design & Create Kit**

This kit is a great introductory set to combine design, art, technology, engineering, maths and science and to start building. Whether this is a craft project, to design a perfect architectural structure, a 3D maths shape, accessory, bridge, tower or anything else your imagination guides you. This set includes:

- 5 sets of 1000 Large Paddle Pop Sticks (JM67)
- 5 sets of 1000 Small Paddle Pop Sticks (SH956)
- 4 Low Melt Glue Guns (TH120)
- 10 sets of 10 Low Melt Glue Sticks (TH121)
- 80 Litre Storage Container (K80L)

MS120K \$208.95

## STEM &amp; Makerspace Materials

## Construction Value Pack

A complete construction pack. Each pack includes: 500 x IQ sticks (115mm L x 10mm W), 50 x Spools (15 x 15mm and 22 x 20mm), 50 x Mini Dolly Pegs (60mm L x 80mm W), 100 x Blocks (15 x 15mm), 100 x Mini Round Sticks (80mm L x 3mm W), 100 x Jumbo Craft Sticks with holes (150mm L x 20mm W) and 100 x Round Sticks (150mm L x 4mm W). Available in plain (SH962) or coloured varieties (SH963). Packs of 1000.

SH962  
SH963

Plain \$69.95  
Coloured \$72.95



Pack of  
60



creativistics

## Assorted Cardboard Tubes

Made from sturdy cardboard, these assorted diameter tubes are a great addition to all craft cupboards. Size: 10(L)cm and diameters of 2, 3, 5 and 7cm. Pack of 60.

TH981

Pack of 60 \$19.95



## Balsa Wood

Lightweight wood that is excellent for modelling, carving and constructing. Build and stack to make buildings or skyscrapers. Set includes sticks, blocks and sheets. Approximately 3kg.

ATM10801

\$125.95



## Wearable Technology Class Pack

The wearable technologies class pack allows students to practise with simple electronic circuits, while being creative as they incorporate electronic technologies into clothing and accessories.

EIS1590

\$239.95



## Dough - 900g

Creativistics dough comes in an assortment of colours that are pliable and easy to mould. Children can use their hands to create fun 3D designs with this soft and colourful dough. Non-toxic. Size: 900g tubs. The set of 6 (CS2049) includes colours red, yellow, green, blue, orange and purple. The assorted tub (CS2056) includes 150g of each of these 6 colours. The Pastel set (CS2900) includes colours purple, blue, green, pink, orange and yellow. The skin tone set (CS2901) includes a mix of natural colours.

CS2049  
CS2050  
CS2051  
CS2052  
CS2053  
CS2054

Set of 6 \$57.95  
Red \$9.95  
Yellow \$9.95  
Green \$9.95  
Blue \$9.95  
Orange \$9.95



12 x 500g Clay +  
12 Cutters  
**\$56.95**  
—  
Save \$6.95

creativistics

## Modelling Clay

Creativistics Modelling Clay is easy to mould and comes in 12 bright colours. The kit of 12 includes all colours and a bonus set of 12 clay cutters. Size of each block of clay: 500g. Ages 3+ years.

KC1020

12 x 500g Clay + Cutters \$56.95

**WARNING: Contains coin/button battery. Hazardous if swallowed. Seek immediate medical attention if swallowed.**

### USB & Bluetooth + Charging Tray

Get the most out of your lessons by giving students the chance to work in groups as they discover science together. V-Hub4 (SER100432) five pack solution works with the entire SmartQ sensor range. With a built-in rechargeable battery, V-Hub8 (SER100434) powers all of the sensors. With built in sensors, USB, bluetooth and optional Wi-Fi connectivity, V-Log8 (SER100438) offers all the features you need at a groundbreaking price!

SER100432	5 x V-Hub4	\$1,499.95
SER100434	5 x V-Hub8	\$1,899.95
SER100438	5 x V-Log8	\$2,499.95



### Data Logger EasySense – USB & Bluetooth

With USB, Wi-Fi and Bluetooth options, alongside our FREE EasySense software for PC Windows, Mac OS, iPad iOS, Android & Chromebooks (that support Android Apps), we offer a versatile yet simple solution that will cover all of your data logging requirements. With a built-in rechargeable battery, V-Hub8 powers all of the sensors. Classroom management is simplified, as only the V-Hub8 needs re-charging! The V-Hub8 is small and light, it can be mounted on a retort stand along with the experiment apparatus, using the mounting rod supplied.

SER2504PK	V-Hub4 – USB & Bluetooth	\$259.95
SER2508PK	V-Hub8 – USB & Bluetooth	\$349.95



### Data Logger EasySense – VLog

With built-in USB connectivity and optional Wi-Fi, offers all the remote data logging features you need at a ground breaking price! 4 SmartQ sensor inputs, Large graphical display, Remotely record data (14 days), Fast logging mode (50,000 samples per second), Accurate digital timing mode (4 microseconds), Built-in battery, USB rechargeable, USB & Bluetooth connectivity, Optional Wi-Fi module







SER2404PK	VLog 4 (USB)	\$329.95
SER2408PK	VLog 8 (USB)	\$399.95











## Smart Q Sensors





## Data Logger Smart Q Sensors

Award winning SmartQ technology offering uncompromised levels of accuracy and reliability. With over 50 sensors to choose from, there's a sensor available for almost all scientific experiments.

SER3201	Accelerometer (High G)	The sensor has two measurement axis, the x axis (along the length of the sensor) and the y axis (across the width of the sensor). A resultant range combines the readings of both axis to create a change of force sensor. The high g sensor measures forces in the range of $\pm 40g$ or $0 - 500 \text{ ms}^{-2}$ . Ideal for measuring the forces in collisions between Data Harvest dynamics carts. Teaching applications: Force changes in collisions, Showing equal and opposite forces in collisions	\$199.95	
SER3200	Accelerometer (Low G)	The sensor has two measurement axis, the x axis (along the length of the sensor) and the y axis (across the width of the sensor). A resultant range combines the readings of both axis to create a change of force sensor. The low g sensor measures forces in the range of $\pm 10.0 g$ or $\pm 100.0 \text{ ms}^{-2}$ . Ideal for measuring the forces in collisions between Data Harvest dynamics carts. Teaching applications: Force changes in collisions, Showing equal and opposite forces in collisions	\$199.95	
SER3297PK	Anemometer Pack	This pack contains an Anemometer and Count Tachometer adaptor. The Anemometer is constructed using a high-quality ball bearing, stainless steel hardware, UV stable plastic, and durable anodized aluminium hemispherical cups that are weight matched. The Anemometer uses a double contact reed switch, so counts twice for each complete rotation . Teaching applications: Weather, Air Speed	\$299.95	
SER3190PK	Breathing Rate Belt & Pressure	The SmartQ $\pm 10\text{kPa}$ Differential Gas Pressure sensor (3139) and Breathing Rate belt (3190) in this pack are used together to measure the expansion and contraction of a person's chest while they breathe. The Breathing Rate belt is wrapped around a person's chest region. Fitted inside the Belt is an inflatable air bladder, which is moulded to two rubber tubes. One of these tubes finishes with a hand pump bulb that is used to inflate the air bladder. The other tube is attached to the Gas Pressure Sensor which monitors the change in pressure during breathing.	\$229.95	
SER3152	Carbon Dioxide Sensor (CO2)	Measure and record the carbon dioxide changes in the environment. The sensor is designed and optimised to measure carbon dioxide levels found in the air around photosynthesising plants and small, respiring animals. The unique disc shape lets the sensor become the lid for respiration chambers or placed on a desk without the need for clamps and stands.	\$499.95	
SER3268	Charge Sensor	Used to measure the amount of charge on a source when the charge available is very small as in many electrostatic experiments. It can replace a traditional gold leaf electroscope by showing not only the polarity of the charge but also performing measurements. It can also measure the potential difference between two points.	\$229.95	

SER3135	Conductivity Adaptor	The Smart Q Conductivity adaptor enables a Conductivity electrode to be connected to an EasySense data logging unit. The EasySense data logging unit will detect when the Conductivity adapter is connected and which of the ranges it is set to. The Smart Q Conductivity Sensor is used to measure the conductivity of a solution. The Conductivity electrode is a simple epoxy-bodied carbon (graphite plate) type selected for its durability in field use. It is ideal for measuring salinity and changes in conductivity of a water sample. It can be used by chemists for investigating the difference between ionic and molecular compounds in an aqueous solution.	\$99.95	
SER3136	Conductivity Electrode	The Conductivity electrode is manufactured from epoxy and has graphite plate electrodes. This construction offers good durability in field use. It is ideal for measuring salinity and changes in conductivity of a water sample. The sensor cannot identify the specific ions that are present, but it can be used to determine the total concentration of ions in a sample. Teaching applications: Ionic studies, Titrations, Polar non polar solutions, Diffusion across membranes.	\$99.95	
SER3260	Crocodile Clips (Pair)	A Crocodile clip lead is normally used attached to a home-made or commercial push to make switch. They can be used singly or in pairs to provide timing and event monitoring.	\$29.95	
SER3166	Current - 100mA	Use in conjunction with voltage sensors to investigate Ohm's law, power and circuits. This high range sensor is very good for measuring start up current in incandescent, filament lamps and for studying fuses. For smaller currents use the 100 mA or 1A sensors.	\$99.95	
SER3167	Current - 10A	Use in conjunction with voltage sensors to investigate Ohm's law, power and circuits. This high range sensor is very good for measuring start up current in incandescent, filament lamps and for studying fuses. For smaller currents use the 100 mA or 1A sensors.	\$99.95	
SER3165	Current +-1A	Use in conjunction with voltage sensors to investigate Ohm's law, power and circuits. This high range sensor is very good for measuring start up current in incandescent, filament lamps and for studying fuses. For smaller currents use the 100 mA or 1A sensors.	\$99.95	
SER3160	Differential Voltage, +- 20V	This Voltage sensor measures the potential difference across any component for both DC and low voltage AC circuits. The 4 mm plugs attach to most of the standard available electronic kits. This sensor can be used anywhere within a circuit.	\$79.95	
SER3161	Differential Voltage, 0-10V	This Voltage sensor measures the potential difference across any component for both DC and low voltage AC circuits. The 4 mm plugs attach to most of the standard available electronic kits. This sensor can be used anywhere within a circuit.	\$79.95	
SER3160-12	Differential Voltage, 12V	This Voltage sensor measures the potential difference across any component for both DC and low voltage AC circuits. The 4 mm plugs attach to most of the standard available electronic kits. This sensor can be used anywhere within a circuit.	\$79.95	

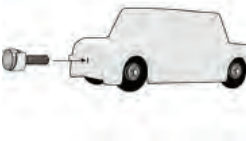
## Smart Q Sensors

SER3162	Differential Voltage, 1V	This Voltage sensor measures the potential difference across any component for both DC and low voltage AC circuits. The 4 mm plugs attach to most of the standard available electronic kits. This sensor can be used anywhere within a circuit.	\$79.95	
SER3266	Drop and Bubble Counter	This sensor offers exceptional value as it performs a dual role. In Chemistry its primary role is as a drop counter measuring accurately the volume of titrant added during a titration. However, this sensor can be used to monitor bubbles produced during gas production from either a chemical reaction or a biological process.	\$199.95	
SER3800	Dynamics System	This self-assembled, matt black anodized 1.2 m aluminium incline track and support pillar comes with a low friction cart with its interrupt card and various brackets to form a high quality modular dynamics track. This self-assembled, matt black anodized 1.2 m aluminium incline track and support pillar comes with a low friction cart with its interrupt card and various brackets to form a high quality modular dynamics track. SmartQ sensors are aligned easily to give reliable, repeatable accurate results. Designed for use with SmartQ Light Gates, Motion sensor, Rotary Motion sensor, Spoked Pulley, Force Sensor, Laser module and Light Level sensor.	\$399.95	
SER3801	Dynamics System Extension Pack	This self-assembled, matt black anodized 1.2 m aluminium incline track and support pillar comes with a low friction cart with its interrupt card and various brackets to form a high quality modular dynamics track. This self-assembled, matt black anodized 1.2 m aluminium incline track and support pillar comes with a low friction cart with its interrupt card and various brackets to form a high quality modular dynamics track. SmartQ sensors are aligned easily to give reliable, repeatable accurate results. Designed for use with SmartQ Light Gates, Motion sensor, Rotary Motion sensor, Spoked Pulley, Force Sensor, Laser module and Light Level sensor.	\$199.95	
SER3821	Dynamics System, Cart Only	This self-assembled, matt black anodized 1.2 m aluminium incline track and support pillar comes with a low friction cart with its interrupt card and various brackets to form a high quality modular dynamics track. This self-assembled, matt black anodized 1.2 m aluminium incline track and support pillar comes with a low friction cart with its interrupt card and various brackets to form a high quality modular dynamics track. SmartQ sensors are aligned easily to give reliable, repeatable accurate results. Designed for use with SmartQ Light Gates, Motion sensor, Rotary Motion sensor, Spoked Pulley, Force Sensor, Laser module and Light Level sensor.	\$59.95	



SER3802	Dynamics System, Track Only	This self-assembled, matt black anodized 1.2 m aluminium incline track and support pillar comes with a low friction cart with its interrupt card and various brackets to form a high quality modular dynamics track. This self-assembled, matt black anodized 1.2 m aluminium incline track and support pillar comes with a low friction cart with its interrupt card and various brackets to form a high quality modular dynamics track. SmartQ sensors are aligned easily to give reliable, repeatable accurate results. Designed for use with SmartQ Light Gates, Motion sensor, Rotary Motion sensor, Spoked Pulley, Force Sensor, Laser module and Light Level sensor.	\$229.95
SER3279	E.C.G	The ECG sensor measures the electrical energy generated during a heartbeat. To record the classic PQRST wave, the sensor's three electrodes can be attached to the skin of the user's forearms using disposable ECG patches.	\$249.95
SER3286	ECG Patches	The sensor is supported with a comprehensive user guide (available from the Resources tab). Each sensor is supplied with a pack of 100 disposable ECG electrode patches.	\$39.95
SER3143	Force Sensor	This sensor features safety stops and a solid aluminium housing, making it a useful device for measuring push and pull (bi-directional) forces in a broad $\pm 50\text{N}$ range.	\$199.95
SER3142	Gas Pressure - Absolute 700kPa	Measures the absolute pressure of the system it is connected to. Range of 0 - 700kPa making it ideal for Boyle's law. Single port absolute pressure.	\$149.95
SER3210	Gas Pressure - Absolute, Barometer, Altimeter	Measures the absolute pressure of the system it is connected to. Range of 0 - 700kPa making it ideal for Boyle's law. Single port absolute pressure.	\$159.95
SER3138	Gas Pressure Accessory Pack	Measures the absolute pressure of the system it is connected to. Range of 0 - 700kPa making it ideal for Boyle's law. Single port absolute pressure.	\$49.95
SER3139	Gas Pressure, Differential 10kPa	This sensor measures the differential pressure between its two ports. If one port is open to the atmosphere then the sensor measures pressure relative to the atmospheric pressure. With both ports open to the atmosphere, the reading is 0. Blowing into one port will produce a positive value, whereas blowing into the other port will produce a negative value.	\$149.95
SER3141	Gas Pressure, Differential 200kPa	This sensor measures the differential pressure between its two ports. If one port is open to the atmosphere then the sensor measures pressure relative to the atmospheric pressure. With both ports open to the atmosphere, the reading is 0. Blowing into one port will produce a positive value, whereas blowing into the other port will produce a negative value.	\$149.95
SER3265	Geiger Müller	The Geiger Muller sensor is used to monitor Alpha, Beta and Gamma radiation.	\$729.95
SER3147	Heart Rate and Pulse Waveform	Continuously monitor the heart rate at rest and after exercise. Simple finger clip design uses infrared to monitor blood volume in fingers and calculate heart rate.	\$149.95



## Smart Q Sensors

SER3147SPP	Heart Rate, Pulse Ear, Spare Part	Continuously monitor the heart rate at rest and after exercise. Simple finger clip design uses infrared to monitor blood volume in fingers and calculate heart rate.	\$19.95	
SER3145	Humidity	This sensor measures water vapour content relative to the ambient temperature.	\$149.95	
SER3278	Infrared	All warm objects emit infrared radiation. This sensor, therefore, can be used to detect the location of any warm item or living organism. When set to its most sensitive mode, the sensor can detect very low IR emissions, such as the heat trail left on a bench top after you move your hand away.	\$249.95	
SER3107	K-Type Thermocouple	The wide temperature range of this sensor enables it to be used in a variety of experiments e.g. melting points and flame profiles.	\$59.95	
SER3285	Laser Module	This solid-state Laser module draws power from an EasySense logger to produce a red light of 645 to 665 nm wavelength	\$149.95	
SER3250	Light Gate (Each)	The Light Gate has an infrared transmitter and receiver that will detect an object passing through the 'gate'. They can be used singly or in pairs for time, speed, velocity, acceleration and event monitoring. Designed to work seamlessly with the Data Harvest Dynamics system and timing part of the EasySense software. Ideal for all your dynamics / mechanics / kinematics work.	\$99.95	
SER1113210A	Light Gate Spare Rod	The Light Gate has an infrared transmitter and receiver that will detect an object passing through the 'gate'. They can be used singly or in pairs for time, speed, velocity, acceleration and event monitoring. Designed to work seamlessly with the Data Harvest Dynamics system and timing part of the EasySense software. Ideal for all your dynamics / mechanics / kinematics work.	\$4.95	
SER3124	Light Level, Multi Range	A light sensor that is balanced to the human eye spectral response. 5 ranges to cover 0 -100,000 lx and a transmission range for home made colorimeters. One of the essential sensors for data logging.	\$129.95	
SER3172	Magnetic Field 100mT	Explore the nature and strengths of magnetic fields of solenoids and permanent magnets with this robust sensor which houses two switchable Hall effect transducers to measure accurately both Radial and Axial magnetic fields.	\$149.95	
SER3170	Magnetic Field 10mT	Explore the nature and strengths of magnetic fields of solenoids and permanent magnets with this robust sensor which houses two switchable Hall effect transducers to measure accurately both Radial and Axial magnetic fields.	\$149.95	
SER3270	Motion Sensor	The Motion sensor can capture the motion of running students, falling basketballs and carts on inclined planes. Featur-ing an industry leading sample rate of 50Hz, this sensor works well with the Dynamics System or Dynamics Track.	\$249.95	
SER3130	Oxygen Adaptor	This adaptor is used in conjunction with the Oxygen Electrode to form the dual range Oxygen sensor, capable of measur-ing oxygen levels in air, or dissolved oxygen levels in water.	\$119.95	

SER3125	pH Adaptor	This adaptor is used in combination with a pH electrode to form the immensely popular pH sensor. The Smart Q pH sensor has both a pre-set calibration range (so the sensor is ready for immediate use in Chemistry or Biology) and a user calibration range.	\$119.95	
SER1113206	pH Electrode	Electrode for the Data Harvest pH sensor.	\$88.95	
SER3274	Polar Heart Rate Belt, Large	Wireless connectivity between the sensor and the data logger make this an ideal sensor to monitor heart rate during exercise. This sensor consists of a belt that is worn around the ribcage against the skin, and a receiver that is connected to the logger. The transmitter can be up to 80 cm from the receiver.	\$19.95	
SER3273	Polar Heart Rate Belt, Small, for 1113290	Wireless connectivity between the sensor and the data logger make this an ideal sensor to monitor heart rate during exercise. This sensor consists of a belt that is worn around the ribcage against the skin, and a receiver that is connected to the logger. The transmitter can be up to 80 cm from the receiver.	\$19.95	
SER3148	Polar Heart Rate Exercise Sensor	Wireless connectivity between the sensor and the data logger make this an ideal sensor to monitor heart rate during exercise. This sensor consists of a belt that is worn around the ribcage against the skin, and a receiver that is connected to the logger. The transmitter can be up to 80 cm from the receiver.	\$199.95	
SER3261	Push Button Reaction Switch	Fitted with a red LED, a pair of these switches can be used to test students' reaction times. One switch can also be used for manual marking of events during data logging activities.	\$39.95	
SER3298	Rain Gauge	This is a 'tipping bucket' type rain gauge. As rain falls the water runs down through the collecting funnel into a self-emptying spoon which tips and empties each time the equivalent of 1 mm of rain has fallen. Total rainfall is measured by counting how many times the bucket tips.	\$119.95	
SER3298PK	Rain Gauge Pack	This is a 'tipping bucket' type rain gauge. As rain falls the water runs down through the collecting funnel into a self-emptying spoon which tips and empties each time the equivalent of 1 mm of rain has fallen. Total rainfall is measured by counting how many times the bucket tips.	\$229.95	
SER3159	RF Electrosmog Sensor	The RF Electrosmog sensor is a broad bandwidth RF detector. It can detect RF over the frequency range 50 MHz to 3 GHz.	\$129.95	
SER3280	Rotary Motion	This 8 range sensor is a must for every Physics department. It is highly accurate and capable of measuring a variety of motions including: Linear displacement by using any of the pulley ranges or the linear rack attachment (from the Rotary Motion Accessory Pack. Linear displacement by using any of the pulley ranges or the linear rack attachment (from the Rotary Motion Accessory Pack. Angular velocity using either the revolutions or radians per second range.	\$329.95	
SER3288	Rotary Motion Accessory Pack	See the Rotary Motion Accessory Pack which contains a linear rack attachment, pendulum rod with 2 masses and an angular motion disc set.	\$149.95	



## Smart Q Sensors

SER3473	Solar Photovoltaic Set	A solar panel (photovoltaic cell) has special components that transfer the sun's radiation directly into electricity. This set includes the solar panel, a motor box, a buzzer box and a LED box so you can explore power-ing these components using the electricity generated by the photovoltaic cell	\$149.95	
SER3472	Solar Water Heater Set	The solar water heater will absorb energy from the sun and rapidly use it to heat water. This easy to use set includes a solar water heater and digital thermometer in a plastic case. It can be used outdoors in the sun or indoors with a desk lamp. This set can be used as it is or you can add a data logger and Temperature sensor to monitor how long it takes for the water to get hot, and what happens when it's cloudy. A Light level sensor will record changes in sun conditions so this can be compared with the rise in temperature.	\$149.95	
SER3175	Sound Level	Dual range sensor that accurately measures both sound pressure level in decibels (dBA) or waveform (mV).	\$119.95	
SER3267	Spirometer	A spirometer that is portable, small, compact and needs no special gases or water. The hand held unit measures air flow by pressure difference. A utility in the Easysense software converts flow data to volume data. You can measure lung capacities, flow volume loops and lung ventilation efficiency	\$249.95	
SER3269	Spirometer Filters	A spirometer that is portable, small, compact and needs no special gases or water. The hand held unit measures air flow by pressure difference. A utility in the Easysense software converts flow data to volume data. You can measure lung capacities, flow volume loops and lung ventilation efficiency.	\$59.95	
SER3264	Spirometer Nose Clips	A spirometer that is portable, small, compact and needs no special gases or water. The hand held unit measures air flow by pressure difference. A utility in the Easysense software converts flow data to volume data. You can measure lung capacities, flow volume loops and lung ventilation efficiency.	\$29.95	
SER3177	Spoked Pulley	This precision 10 segment, low friction pulley produces excellent results in a Physics lab. It can be attached to a Light Gate, Rotary Motion Sensor or used with the Dynamics System.	\$26.95	
SER3176PK	Stethoscope Sensor Pack	The Stethoscope sensor allows you to record the heart sounds and the echoes of the beat in the circulation. With the addition of an ECG sensor and a Heart wave sensor a full physiology of the heart cycle can be recorded and analysed.	\$109.95	
SER3296	Tachometer Adaptor	Counts pulses and presents the data as either a number of events or a rate value. 11 ranges to select. The adaptor has two inputs, one for SmartQ digital sensors (light gates, push switches), and the other for simple switches (user created) terminating in a 3.5mm jack plug.	\$99.95	
SER3100	Temperature (Stainless)	This general-purpose temperature probe is the most commonly used sensor in the range. It can accurately measure the temperature of air, water, soil and weak acidic solutions, making it indispensable in all Science Departments.	\$69.95	

SER3101	Temperature Fast	A different type of thermometer, with low thermal mass and quick response times. Ideal for recording temperatures from low grade heat sources. The quick response times let you monitor changes in temperature over short times. This is not water, acid or alkali resistant, if this is required use the standard temperature sensor.	\$69.95
SER3105	Temperature High (K-Type)	The wide temperature range of this sensor enables it to be used in a variety of experiments e.g. melting points and flame profiles.	\$159.95
SER3255	Timing Mats (Pair)	Timing mats are pressure sensitive switches designed to be activated as you step on and off the mat. These are the smaller of the two sizes of mats that are available.	\$79.95
SER3277	Ultraviolet Sensor	A multi-range sensor sensitive to UVA and the harmful UVB band of the spectrum. Six measurement ranges covering 0 -500W/m2.	\$199.95
SER3471	Wind Energy Set	The Wind Turbine Kit is a great way to explain the function and benefits of using wind power to generate electricity	\$399.95
SER3173	Wire Coil and Magnet	A 500 turn wire coil with built-in interface suppressor. When used in an electromagnetic induction investigation, the best results will be obtained by using either the $\pm 100\text{mA}$ Current or $\pm 1\text{V}$ Voltage sensors.	\$99.95
SER3131	Data Logger Smart Q Sensor- Oxygen Electrode	This electrode is used in combination with the Oxygen Adaptor to form the dual range Oxygen sensor, capable of measuring oxygen levels in air, or dissolved oxygen levels in water.	\$229.95
SER3190	Datalogger Smart Q Sensor – Breathing Rate Belt	This belt is used with the SmartQ 10kPa Differential Gas Pressure sensor (SER3139) to measure the expansion of the chest whilst a person breathes.	\$79.95
SER3275	Datalogger Smart Q Sensor – Colorimeter	This instrument can be used for investigations which result in a change in colour or opacity e.g. Beer's law, enzyme kinetics and chemical rate of reaction experiments.	\$229.95
SER3903	Datalogger Smart Q Sensor – Finger Tip Pulse	This sensor is designed to fit on the tip of a finger.	\$99.95
SER3841	Datalogger Smart Q Sensor – Friction Ramp Switches	The switches are magnetic proximity switches which fit into the two holes in the timing ramp.	\$49.95
SER1113032	Datalogger Smart Q Sensor – Handheld Dynamo 6V	This instrument is perfectly suited to experiments that explain the mechanism of power generation in an easy and fun way.	\$99.95
SER3803	Datalogger Smart Q Sensor – Interrupt Cards	This set allows students to explore momentum, kinetic energy, acceleration, distance and speed.	\$49.95
SER6172	Datalogger Smart Q Sensor – Oxygen Maintenance Kit	Maintenance kit for the oxygen electrode consisting of three spare membranes and 50 ml of electrolyte.	\$129.95
SER3179	Datalogger Smart Q Sensor – Speed Of Sound Pack	The Speed Of Sound Sensors can either be used to listen to heart beats or to measure speed of sound through air and other materials. This pack contains 2 stethoscope sensors.	\$229.95



## Smart Q Sensors &amp; Vu Sensors &amp; Accessories

SER3271	Datalogger Smart Q Sensor- Drop Bub Counter Replacements	Two 3 way Stopcocks and five plastic tips – replacement parts for the Drop & Bubble Counter.	\$29.95	
SER3907	Datalogger Smart Q Sensor- Fingertp Pulse Oximeter	The pulse oximeter can be used to measure human haemoglobin saturation and heart rate through a fingertip.	\$129.95	
SER3272	Datalogger Smart Q Sensor- Heart Rate Receiver-Polar T31	This is the T31 transmitter part of the transmitter belt for the Polar Heart rate sensor.	\$109.95	

## Vu Sensors &amp; Accessories

SER2305PK5	5 x Vu+ Pack Usb & Bluetooth + Charging Tray	This convenient 5 pack solution also includes integral USB charging system and a smart Grattnell's storage tray.	\$1,299.95	
SER2305PK	Data Logger Vu Sensor – Vu+ Pack, USB & Bluebooth	The low cost primary data logging solution. Now with Bluetooth connectivity to iPad & Android tablets. With a large easy to read display that shows data as numbers, pictograms, blocks and bars. Vu+ is a new generation logger and software package that grows with the children, it never gets left behind and offers exceptional value for money.	\$229.95	
SER2327	Data Logger Vu Sensor – Heart Rate Sensor	Pupils of all ages are keenly interested in how physical and mental stress affects their heart rate. The sensing clip (pleth) can be attached to a finger or ear lobe to measure either blood flow (pulse waveform) or heart rate (beats per minute)	\$59.95	
SER100200	Data Logger Vu Sensor – Power House	With this power house you can explore alternative energy and sustainable living. Build the house and then conduct the 100 activities centred in and around the house. A 64 page booklet describes the activities and gives background science to understand the work. Connect the included solar panels to the Vu logger Voltage sensor (supplied) and see how much electricity is made.	\$269.95	
SER2320	Data Logger Vu Sensor – Temperature	This general-purpose Temperature sensor is the most commonly used sensor in the range. It can accurately measure the temperature of air, water, soil and weak acidic solutions	\$19.95	
SER2330PK	Data Logger Vu Sensor- Timing Gates (Pair)	A pack of 2 Vu Light gates which are digital switch-type sensors. A single Light gate can be used to measure time and speed at A or use a pair of Light gates to measure time and speed from A to B	\$99.95	
SER2325	Data Logger Vu Sensor – Voltage	This Voltage sensor measures the voltage across any component for DC low voltage circuits from 0 to 3 V.	\$19.95	
SER2332PK	Data Logger Vu Sensor – Vu Timing Mats	These large mats are activated by stepping onto them; one mat is used to start the timer, the other to stop the timer. Size: 720mm x 390mm	\$99.95	
SER2341	Data Logger Vu Sensor – Friction Ramp Switches	This Switch kit has been designed for use with the Vu Timing Ramp. The switches connect to the timing inputs (A and B) on the Vu or Vu+ data logger.	\$44.95	

**Discovering Science Book Series**

The Discovering Science Teacher book series is fully aligned to the Australian Curriculum and covers each of the three interrelated science strands - Science Understanding, Science as a Human Endeavour and Science Inquiry Skills and also the related sub-strands. It includes subject planners, week-by-week lesson plans and assessment record sheets for the teachers, as well as worksheets, resource and self-evaluation sheets for the students. Each lesson plan includes content descriptions, required resources, skills, a step-by-step activities section, extension activities and assessment ideas.

HB8790K	Set of 7 books	\$265.95
HB8738	Foundation	\$39.95
HB8745	Year 1	\$39.95
HB8752	Year 2	\$39.95
HB8769	Year 3	\$39.95
HB8776	Year 4	\$39.95
HB8783	Year 5	\$39.95
HB8790	Year 6	\$39.95



**Complete Curriculum Kits**

Schools wishing to purchase the complete range of Engaging with Science Kits can do so easily. Choose from either the Complete Kit including quality Gratnell frames or simply purchase the standalone kits.

**Complete Curriculum Kits**

TFC57038	Complete Curriculum Kits (24 kits – 2 Frames)	\$8,999.95
TFC57037	Complete Curriculum Kits (24 kits – No Frames)	\$8,999.95

*Buy the complete kit and frames and have a wonderful Science resource to be used for many years.*

<p>TFC57038  <del>\$12,231.65</del>  <b>\$8,999<sup>95</sup></b>                  Save \$3,231.70</p>	<p>TFC57037  <del>\$9,434.80</del>  <b>\$8,999<sup>95</sup></b>                  Save \$434.85</p>
---	--



Bonus Book

Simple to store

Never lose track of resources

Engaging practical materials

## Curriculum Kits

~~\$2,614.50~~  
**\$2,499<sup>95</sup>**  
 Save \$114.55



Bonus  
Book

### Biological Kit - Foundation to Year 6

Help students investigate living things and how they rely on and affect their environments. These kits assist in understanding the diverse range of life we have on Earth.

TFC57000BK

7 Kits \$2,499.95

~~\$2,476.95~~  
**\$2,203<sup>95</sup>**  
 Save \$273.00



Bonus  
Book

### Chemical Kit - Foundation to Year 6

Help students explore relationships between substances and their properties. These kits assist in understanding that substances can change and new substances can be created due to a number of factors.

TFC57000CK

5 Kits \$2,203.95

~~\$2,259.80~~  
**\$2,099<sup>95</sup>**  
 Save \$159.85

Bonus  
Book

### Earth & Space Kit - Foundation to Year 6

Help students explore the processes that result in change to the Earth's surface and the influence human activity has had over these changes. These kits assist in understanding that the Earth is part of a solar system which in its self is part of the larger universe.

TFC57000EK

6 Kits \$2,099.95



~~\$2,762.70~~  
**\$2,549<sup>95</sup>**  
 Save \$212.75

Bonus  
Book

### Physical Kit - Foundation to Year 6

Help students develop an understanding of the concept of motion and energy. These kits assist in understanding that forces affect the behaviour of objects and that energy can be transferred to and from a particular object.

TFC57000PK

6 Kits \$2,549.95





## SIMAX GLASS

Kavalier/Simax have been the leading European producer of borosilicate glass for 180 years! They offer a very wide variety of products which span the areas of domestic, industrial, laboratory and technical glass, pipes and industrial apparatus. Most of Kavalier's products are being distributed under the brands Simax and Kavalier.



The diversity and technical complexity of Kavalier's goods requires continuous innovation, which helps them maintain their position as a world leader of production processes and solutions that keep pace with market trends internationally. Kavalier prides itself on a tradition of quality, meeting or exceeding the requirements of the System of Quality Management based on ISO 9001. A progressive and economically stable company, Kavalier is the largest producer of borosilicate glass in the world, with a melting capacity of over 220 tons of glass per day! Modern Teaching Aids is proud to be their distributor.

### Beakers

High quality borosilicate beakers designed to withstand high temperatures and the harshest chemicals. High quality low form beakers at an affordable price, made in Europe from borosilicate for extreme durability in your laboratory. Designed to withstand high temperatures and the harshest chemicals.

- Leading European manufacturer, with over 175 years of experience manufacturing borosilicate glass
- Borosilicate for the harshest lab environments
- Dish washer and chemical safe graduations

SER5003101	Low Form - 5ml	Each	\$5.95	10 or more - \$5.25
SER5003100	Low Form - 10ml	Each	\$6.95	10 or more - \$6.25
SER5003001	Low Form - 25ml	Each	\$6.95	10 or more - \$6.25
SER5003002	Low Form - 50ml	Each	\$7.95	10 or more - \$7.25
SER5003003	Low Form - 100ml	Each	\$7.95	10 or more - \$7.25
SER5003004	Low Form - 150ml	Each	\$7.95	10 or more - \$7.25
SER5003005	Low Form - 250ml	Each	\$8.95	10 or more - \$7.95
SER5003006	Low Form - 400ml	Each	\$8.95	10 or more - \$7.95
SER5003007	Low Form - 600ml	Each	\$9.95	10 or more - \$8.95
SER5003008	Low Form - 800ml	Each	\$9.95	10 or more - \$8.95
SER5003009	Low Form - 1000ml	Each	\$10.95	10 or more - \$9.50
SER5003010	Low Form - 2000ml	Each	\$12.95	10 or more - \$11.25
SER5003011	Low Form - 3000ml	Each	\$49.95	10 or more - \$44.95
SER5003012	Low Form - 5000ml	Each	\$69.95	10 or more - \$59.95
EIS11015	Low Form - 50ml	Pack 12		\$32.95
EIS11011	Low Form - 100ml	Pack 12		\$45.95
EIS11010	Low Form - 150ml	Pack 12		\$39.95
EIS11012	Low Form - 250ml	Pack 12		\$49.95
EIS11013	Low Form - 500ml	Pack 6		\$39.95
EISKIT4	Low Form Bulk Pack	Kit	\$994.80	\$879.95 Save \$114.85



EIS11012

EIS11010

EIS11015



EIS11011



EIS11013

## Beakers

SER5003013	Low Form with Handle - 250ml	Each	\$9.95	10 or more - \$8.95
SER5003014	Low Form with Handle - 400ml	Each	\$11.95	10 or more - \$10.95
SER5003015	Low Form with Handle - 600ml	Each	\$12.95	10 or more - \$11.25
SER5003016	Low Form with Handle - 1000ml	Each	\$14.95	10 or more - \$12.50
SER5003102	Tall Form - 25ml	Each	\$9.95	10 or more - \$8.95
SER5003103	Tall Form - 50ml	Each	\$4.95	10 or more - \$4.50
SER5003104	Tall Form - 100ml	Each	\$5.95	10 or more - \$5.25
SER5003099	Tall Form - 250ml	Each	\$5.95	10 or more - \$5.25
SER5003106	Tall Form - 400ml	Each	\$6.95	10 or more - \$6.25
SER5003098	Tall Form - 600ml	Each	\$7.95	10 or more - \$7.25
SER5003097	Tall Form - 800ml	Each	\$10.95	10 or more - \$9.95
SER1052396	Tall Form - 1000ml	Each	\$10.95	10 or more - \$9.95
SER5003107	Tall Form - 2000ml	Each	\$14.95	10 or more - \$12.95
SER5003108	Tall Form - 3000ml	Each	\$49.95	10 or more - \$44.95



SER5003016



SER1052396

## Glass Beads

Use as boiling stones and as packing for distillation columns. The beads are resistant to attacks from the majority of hot and cold liquids.

SER1007039 8mm Diameter - 500g \$7.95



## Bell Jar with Knob

This jar is ideal to maintain a low pressure environment and for easy access to items.

SER1052434 200 x 300ml \$79.95



## Bell Jar with Stopper

This bell jar is designed to contain a vacuum as well as to cover and protect items in the laboratory.

SER1052492 150 x 250mm \$49.95

## Reagent Bottles

Leading European manufacturer, with over 175 years of experience manufacturing borosilicate glass.

- Used in chemistry, pharmacy, health, biology and food applications

- Used in more than 90 countries worldwide

SER5003042	Brown Round – 50ml	Each	\$19.95	10 or more – \$17.95
SER5003043	Brown Round – 250ml	Each	\$29.95	10 or more – \$24.95
SER5003044	Brown Round – 500ml	Each	\$39.95	10 or more – \$32.95
SER5003046	Brown Round – 1000ml	Each	\$49.95	10 or more – \$39.95
SER5003081	Brown Square – 500ml	Each	\$59.95	10 or more – \$49.95
SER5003082	Brown Square – 1000ml	Each	\$59.95	10 or more – \$49.95
SER5003083	Brown Square – 2000ml	Each	\$79.95	10 or more – \$69.95
SER5003084	Brown Square – 5000ml	Each	\$349.95	
SER5003041	Clear Round – 50ml	Each	\$6.95	10 or more – \$7.25
SER5003034	Clear Round – 100ml	Each	\$6.95	10 or more – \$6.25
SER5003035	Clear Round – 250ml	Each	\$6.95	10 or more – \$6.25
SER5003036	Clear Round – 500ml	Each	\$6.95	10 or more – \$6.25
SER5003037	Clear Round – 1000ml	Each	\$9.95	10 or more – \$8.95
SER5003038	Clear Round – 2000ml	Each	\$15.95	10 or more – \$14.95
SER5003039	Clear Round – 5000ml	Each	\$99.95	10 or more – \$79.95
SER5003077	Clear Square – 500ml	Each	\$12.95	10 or more – \$11.95
SER5003078	Clear Square – 1000ml	Each	\$18.95	10 or more – \$16.95
SER5003079	Clear Square – 2000ml	Each	\$28.95	10 or more – \$23.95
SER5003080	Clear Square – 5000ml	Each	\$199.95	
SER1052477	Amber Narrow Mouth – 125ml	Each	\$5.95	10 or more – \$5.25
SER1052437	Amber Narrow Mouth – 250ml	Each	\$6.95	10 or more – \$6.25
SER1052438	Amber Narrow Mouth – 500ml	Each	\$7.95	10 or more – \$7.25
SER1052494	Amber Narrow Mouth – 1000ml	Each	\$13.95	10 or more – \$12.95
SER1052497	Clear Narrow Mouth – 60ml	Each	\$3.95	10 or more – \$3.50
SER1052475	Clear Narrow Mouth – 125ml	Each	\$4.95	10 or more – \$4.50
SER1052436	Clear Narrow Mouth – 250ml	Each	\$6.95	10 or more – \$6.25
SER1007032	Clear Narrow Mouth – 500ml	Each	\$7.95	10 or more – \$7.25
SER1052476	Clear Narrow Mouth – 1000ml	Each	\$11.95	10 or more – \$10.95
SER1052441	Amber Wide Mouth – 250ml	Each	\$6.95	10 or more – \$6.25
SER1052493	Amber Wide Mouth – 1000ml	Each	\$11.95	10 or more – \$10.95
SER1142999	Amber Wide Glass Stopper- 10000ml	Each	\$77.95	
SER1052483	Clear Wide Mouth – 125ml	Each	\$4.95	10 or more – \$4.50
SER1052439	Clear Wide Mouth – 250ml	Each	\$6.95	10 or more – \$6.25
SER1052440	Clear Wide Mouth – 500ml	Each	\$7.95	10 or more – \$7.25
SER1052495	Clear Wide Mouth – 1000ml	Each	\$9.95	10 or more – \$8.95



SER5003046



SER5003082



SER5003037



SER5003078



SER1052477



SER1052475



SER1052441



SER1052439



SER1142999

## Burettes

## Glass Burette

High quality burette fitted with a teflon rotoflow valve, graduations that are very clear and permanent.



## Glass Burette with PTFE Stopcock

Designed for precision in analytical chemistry. High quality 50ml burette fitted with a teflon rotoflow valve, graduations that are very clear and permanent.

SER6007006  
SER6007008

50 x 0.1ml \$29.95  
100 x 0.02ml \$39.95



## Glass Schellbach Burette with PTFE Rotoflow

High quality 50ml and 100ml burettes fitted with a teflon rotoflow valve, graduations that are very clear and permanent.

SER6007002

\$29.95



## Glass Burette with PTFE Valve

Designed for precision in analytical chemistry. High quality 50ml burette fitted with a teflon rotoflow valve, graduations that are very clear and permanent.

SER6007003

50 x 0.1ml \$12.95



## Diji Burette

This innovative product provides all the functions of a burette with added benefits such as versatility and exceptional control. The burette provides high level of accuracy and can be preconditioned quickly and easily for reuse with different chemicals. Accuracy is not affected by bubbles in the burette.

SER1529006

50ml \$69.95



SER6007001



SER1052465

## Glass Burette with Glass Valve

Graduated 50ml burettes designed for precision in analytical chemistry

SER6007001  
SER1052465

Schellbach \$29.95  
B Grade - 50 x 0.1ml \$18.95



## Glass Burette with PTFE Stopcock - B Grade - 50 x 0.1ml

Designed for quantitative analysis in microchemistry.

SER1052064

Schellbach \$23.95



### Clear Dropping Bottle 50ml

These clear glass dropping bottles have a capacity of 60ml. Made from borosilicate glass.

EIS0194B  
10 or more

\$7.95  
Each \$7.25



### Dropping Bottles

Use the dropping bottles to dispense indicators, stains or reagents. Designed to be strong and leak proof.

SER1152102  
SER1012038  
10 or more  
SER1012027  
10 or more

Amber with Dropper - 50ml \$14.50  
Clear - 30ml \$4.95  
Each \$4.50  
Clear - 125ml \$5.95  
Each \$5.25



SER1097007



SER1097008



SER1097009

### Coplin Jar

A glass vessel with grooves or racking inside for holding microscope slides vertical during the process of staining or washing.

SER1097007  
SER1097008  
SER1097009

10 Slide Capacity \$36.95  
5 Slide Capacity \$11.95  
Screw on Lid - 5 Slide Capacity \$4.95



### Crystallising Dish

Use the crystallising dish for storage, laboratory experiments and for the crystallisation of products.

SER1007061  
SER1007060  
SER1007027

Glass With Spout 250ml \$5.95  
Glass With Spout 300ml \$3.95  
Glass With Spout 2000ml \$16.95



### Glass Desiccator

These desiccators are perfect to preserve laboratory products which are moisture sensitive.

SER1052430  
SER1052431

Knob, Porcelain - 180 x 280mm \$49.95  
Knob, Porcelain - 240 x 360mm \$89.95



### Round Bottom Glass Evaporating Dish

Use the evaporating dishes to evaporate excess solvents from chemical solutions.

SER1007025  
SER1007026

60mm \$4.50  
90mm \$4.60

## Flasks

## Glass Boiling Flasks

EIS0410C	Flat Bottom 100ml	Pack 12		\$51.95
EIS0410E	Flat Bottom 250ml	Pack 12		\$75.95
EIS0410F	Flat Bottom 500ml	Pack 6		\$59.95
EIS0410G	Flat Bottom 1000ml	Pack 6		\$109.95
EISKIT5	Flat Bottom Bulk Pack	Kit	<del>\$595.60</del>	\$534.95 Save \$60.65



SER5003120	Narrow Neck - 50ml	Each	\$13.95	10 or more - \$12.95
SER5003026	Narrow Neck - 100ml	Each	\$4.95	10 or more - \$4.50
SER5003027	Narrow Neck - 250ml	Each	\$5.95	10 or more - \$5.25
SER5003028	Narrow Neck - 500ml	Each	\$6.95	10 or more - \$6.25
SER5003029	Narrow Neck - 1000ml	Each	\$29.95	10 or more - \$24.95
SER5003030	Narrow Neck - 2000ml	Each	\$39.95	10 or more - \$32.95
SER5003040	Narrow Neck - 4000ml	Each	\$59.95	10 or more - \$49.95
SER5003150	Narrow Neck - 6000ml	Each	\$79.95	10 or more - \$69.95



SER5003028

SER1052294	Round Bottom Narrow Neck - 50ml	Each	\$16.95	10 or more - \$14.95
SER5003031	Round Bottom Narrow Neck - 100ml	Each	\$20.95	10 or more - \$18.95
SER5003032	Round Bottom Narrow Neck - 250ml	Each	\$20.95	10 or more - \$18.95
SER5003033	Round Bottom Narrow Neck - 500ml	Each	\$24.95	10 or more - \$21.95
SER5003096	Round Bottom Narrow Neck - 1000ml	Each	\$29.95	10 or more - \$24.95
SER1052456	Round Bottom Narrow Neck - 10000ml	Each	\$119.95	



SER5003032

EIS0402E	Round Bottom - 250ml	Pack of 12		\$51.95
EIS0402F	Round Bottom - 500ml	Pack of 6		\$49.95
EIS0402G	Round Bottom - 1000ml	Pack of 6		\$94.95
EISKIT7	Round Bottom Bulk Pack	Kit	<del>\$393.70</del>	\$374.95 Save \$18.75



EIS0402E

EIS0406B	Pear Shaped - 50ml - 14-23	Each	\$13.95	10 or more - \$11.95
EIS0406C	Pear Shaped - 50ml - 19-26	Each	\$13.95	10 or more - \$11.95



EIS0406B

## Erlenmeyer Flasks

High quality conical flasks at an affordable price, made in Europe from borosilicate for extreme durability in your laboratory. Designed to withstand high temperatures and the harshest chemicals.

- Leading European manufacturer, with over 175 years of experience manufacturing borosilicate glass
- Borosilicate for the harshest lab environments
- Perfectly flat bottom so they wont spill

SER5003018	Narrow Neck - 50ml	Each	\$4.95	10 or more - \$4.50
SER5003017	Narrow Neck - 100ml	Each	\$4.95	10 or more - \$4.50
SER1052399	Narrow Neck - 200ml	Each	\$4.95	10 or more - \$4.50
SER5003019	Narrow Neck - 250ml	Each	\$5.95	10 or more - \$5.25
SER5003021	Narrow Neck - 500ml	Each	\$7.95	10 or more - \$7.25
SER5003022	Narrow Neck - 1000ml	Each	\$13.95	10 or more - \$12.95
SER5003023	Narrow Neck - 2000ml	Each	\$14.95	10 or more - \$13.95
SER5003201	Wide Neck - 50ml	Each	\$19.95	10 or more - \$17.95
SER5003202	Wide Neck - 100ml	Each	\$3.95	10 or more - \$3.75
SER5003203	Wide Neck - 200ml	Each	\$4.95	10 or more - \$4.50
SER5003204	Wide Neck - 250ml	Each	\$5.95	10 or more - \$5.25
SER5003205	Wide Neck - 300ml	Each	\$6.95	10 or more - \$6.25
SER5003206	Wide Neck - 500ml	Each	\$6.95	10 or more - \$6.25
SER5003207	Wide Neck - 1000ml	Each	\$9.95	10 or more - \$8.95
SER5003208	Wide Neck - 2000ml	Each	\$13.95	10 or more - \$12.95



SER5003021



SER5003206

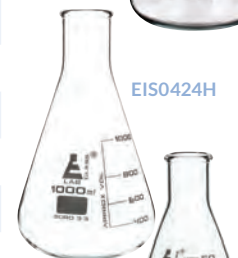

EIS0424H



EIS0424C

EIS0424C	Glass - 50ml	Pack 12		\$39.95
EIS0424D	Glass - 100ml	Pack 12		\$49.95
EIS0424F	Glass - 250ml	Pack 12		\$54.95
EIS0424G	Glass - 500ml	Pack 6		\$54.95
EIS0424H	Glass - 1000ml	Pack 6		\$94.95
EISKIT6	Glass - Bulk Pack	Kit	\$554.55	\$440.95 Save \$173.60



EIS0424F

EIS0424G  
EIS0424D

## Distilling Flasks

High quality flasks at an affordable price, made in Europe from borosilicate for extreme durability in your laboratory. Designed to withstand high temperatures and the harshest chemicals.

- Leading European manufacturer, with over 175 years of experience manufacturing borosilicate glass
- Borosilicate for the harshest lab environments
- Dish washer and chemical safe graduations

SER1052411	Distilling Flask with Side Arm - 250ml	Each	\$11.95
EIS0416B	Distilling Flask with Side Arm - 250ml	Each	\$11.95
EIS0416C	Distilling Flask with Side Arm - 500ml	Each	\$13.95



EIS0416C



EIS0416B

## Flasks

### Volumetric Flasks

EIS0448D	Glass - 50ml	Pack 2	\$18.95
EIS0448E	Glass - 100ml	Pack 2	\$18.95
EIS0448G	Glass - 250ml	Pack 2	\$24.95
EIS0448H	Glass - 500ml	Pack 2	\$28.95
EIS0448I	Glass - 1000ml	Pack 2	\$41.95



SER5003048	A Grade Poly Stopper - 25ml	Each	\$19.95	10 or more - \$17.95
SER5003049	A Grade Poly Stopper - 50ml	Each	\$19.95	10 or more - \$17.95
SER5003050	A Grade Poly Stopper - 100ml	Each	\$24.95	10 or more - \$21.95
SER5003051	A Grade Poly Stopper - 250ml	Each	\$24.95	10 or more - \$21.95
SER5003053	A Grade Poly Stopper - 500ml	Each	\$29.95	10 or more - \$24.95
SER5003054	A Grade Poly Stopper - 1000ml	Each	\$39.95	10 or more - \$32.95
SER5003055	A Grade Poly Stopper - 2000ml	Each	\$69.95	10 or more - \$59.95



SER1007071	B Grade Poly Stopper - 25 x .03ml	Each	\$6.95	10 or more - \$6.25
SER1007072	B Grade Poly Stopper - 50 x .05ml	Each	\$10.95	10 or more - \$9.95
SER1007073	B Grade Poly Stopper - 100 x .01ml	Each	\$12.95	10 or more - \$11.95
SER1007077	B Grade Poly Stopper - 1000 x .40ml	Each	\$19.95	10 or more - \$18.95
SER1007136	B Grade Poly Stopper - 2000 x 1ml	Each	\$29.95	10 or more - \$27.95



### Filter Flasks

SER1052445	Glass With Side Tube - 100ml	Pack 2	\$9.95
SER1052446	Glass With Side Tube - 250ml	Pack 2	\$14.95
SER1052447	Glass With Side Tube - 500ml	Pack 2	\$18.95
SER1007021	Glass With Side Tube - 1000ml	Pack 2	\$39.95



### Distilling Flask

SER1052410	With Side Arm - 100ml	Each	\$8.95	10 or more - \$7.95
------------	-----------------------	------	--------	---------------------





## Funnels

High quality funnels at an affordable price, made in Europe from borosilicate for extreme durability in your laboratory. Designed to withstand high temperatures. Used in chemistry, pharmacy, health, biology and food applications.

### Filter Funnels

SER1008999	Borosilicate Short Stem 45mm	Each	\$1.95	10 or more - \$1.75
SER1052080	Borosilicate Short Stem - 55mm	Each	\$2.50	10 or more - \$2.25
SER1052479	Borosilicate Short Stem - 75mm	Each	\$2.95	10 or more - \$2.50
SER1052081	Borosilicate Short Stem - 85mm	Each	\$3.50	10 or more - \$3.25
SER1052082	Borosilicate Short Stem - 100mm	Each	\$6.50	10 or more - \$5.95
SER1052997	Borosilicate Short Stem - 150mm	Each	\$14.95	10 or more - \$13.95



SER1052997

### Powder Funnels

SER1013140	Short Stem - 60mm	Each	\$19.95	10 or more - \$17.95
SER1013141	Short Stem - 80mm	Each	\$19.95	10 or more - \$17.95
SER1013142	Short Stem - 100mm	Each	\$29.95	10 or more - \$24.95



SER1013140

### Separating Funnels

SER1052481	Glass Cylindrical - 125ml	Each	\$19.95	10 or more - \$17.95
SER1052454	Glass Cylindrical - 250ml	Each	\$33.95	10 or more - \$29.95
SER1052482	Glass Cylindrical - 500ml	Each	\$24.95	10 or more - \$21.95



SER1052454

### Separating Funnels

SER1052503	Glass Pear Shape - 250ml	Each	\$29.95	10 or more - \$24.95
SER1052453	Glass Pear Shape - 500ml	Each	\$27.95	10 or more - \$25.95
SER1052485	Glass Pear Shape - 100ml	Each	\$19.95	10 or more - \$17.95
SER1052480	Glass Pear Shape - 125ml	Each	\$22.95	10 or more - \$20.95
SER1052496	Glass Pear Shape - 250ml	Each	\$24.95	10 or more - \$21.95
SER1052486	Glass Pear Shape - 500ml	Each	\$27.95	10 or more - \$23.95
EIS0479D	Borosilicate Glass - 500ml	Each	\$40.95	10 or more - \$34.95



EIS0479D

### Separating Funnels

SER1052450	Glass Straight - 350mm	Each	\$3.95	10 or more - \$3.75
SER1052451	Glass With Loop - 350mm	Each	\$5.95	10 or more - \$5.25



SER1052450

## Measuring

### Measuring Cylinders

High quality measuring cylinders at a much more affordable price, these are bomex branded units

- Borosilicate for the harshest lab environments
- Dish washer and chemical safe graduations

SER5003056	A Grade - 10ml	Each	\$16.95	10 or more - \$14.95
SER5003057	A Grade - 25ml	Each	\$17.95	10 or more - \$15.95
SER5003058	A Grade - 50ml	Each	\$17.95	10 or more - \$15.95
SER5003059	A Grade - 100ml	Each	\$17.95	10 or more - \$15.95
SER5003060	A Grade - 250ml	Each	\$18.95	10 or more - \$16.95
SER5003061	A Grade - 500ml	Each	\$25.95	10 or more - \$23.95
SER5003062	A Grade - 1000ml	Each	\$49.95	10 or more - \$44.95



SER5003061

SER1008118	B Grade 5ml	Each	\$5.95	10 or more - \$5.25
SER1052084	B Grade - 10ml	Each	\$5.95	10 or more - \$5.25
SER1052085	B Grade - 25ml	Each	\$5.95	10 or more - \$5.25
SER1052086	B Grade - 50ml	Each	\$5.95	10 or more - \$5.25
SER1052087	B Grade - 100ml	Each	\$7.95	10 or more - \$7.25
SER1052088	B Grade - 250ml	Each	\$10.95	10 or more - \$9.95
SER1052089	B Grade - 500ml	Each	\$14.95	10 or more - \$12.95
SER1052090	B Grade - 1000ml	Each	\$29.95	10 or more - \$27.95
SER1052091	B Grade - 2000ml	Each	\$39.95	10 or more - \$34.95



SER1052087

SER1008190	Glass Poly Foot 10ml	Each	\$3.95	10 or more - \$3.75
SER1008205	Glass Poly Foot 25ml	Each	\$6.95	10 or more - \$6.25
SER1008201	Glass Poly Foot 50ml	Each	\$6.95	10 or more - \$6.25
SER1008202	Glass Poly Foot 100ml	Each	\$6.95	10 or more - \$6.25
SER1008203	Glass Poly Foot 250ml	Each	\$8.95	10 or more - \$7.95
SER1008204	Glass Poly Foot 500ml	Each	\$11.95	10 or more - \$10.95



SER1008203

### Gas Jars

SER1052448	With Cover Plate - 50 x 150mm	Each	\$8.95	10 or more - \$7.95
SER1052449	With Cover Plate - 50 x 200mm	Each	\$13.95	10 or more - \$12.95
SER1007058	Glass Lid Cover - 75mm	Each	\$0.95	



SER1052448

## Glass Graduated Cylinders

EIS0344A	10ml	Pack 2	\$9.15
EIS0344A1	25ml	Pack 2	\$10.95
EIS0344B	50ml	Pack 2	\$12.15
EIS0344C	100ml	Pack 2	\$15.95
EIS0344D	250ml	Pack 2	\$21.95
EIS0344E	500ml	Pack 2	\$29.95



EIS0344A1

## Mortar &amp; Pestles

SER1008206	Glass 60mm Diameter	Each	\$7.95
SER1008207	Spare Pestle Glass 100mm	Each	\$2.95



SER1008206

## Petri Dishes

SER1052499	With Cover - 60 x 15mm	Each	\$3.95	10 or more - \$3.50
SER1052414	With Cover - 90 x 18mm	Each	\$4.95	10 or more - \$4.25



SER1052499

## Pneumatic Trough

SER1052435	Glass - 240 x 125mm	Each	\$33.95
------------	---------------------	------	---------



SER1052435

## Diji Burettas

This innovative 3 in 1 product, serves the functions of volumetric pipette, graduated pipette and burette. The burette provides accuracy of ISO A grade pipette and are easy for students to use.

SER1529003	Burette - 5ml	Each	\$69.95
SER1529004	Burette - 10ml	Each	\$69.95
SER1529005	Burette - 25ml	Each	\$69.95



SER1529005

## Diji Standards

This novel product replaces pipette/ bulb pair by providing high level of accuracy whilst making it easy to use. It can also be used as a portable burette. The device provides exceptional control and a suction device is not required to handle liquid.

SER1529002	Standard - 10ml	Each	\$53.95
SER1529001	Standard - 25ml	Each	\$53.95

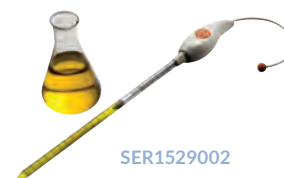

SER1529002

## Measuring

### Glass Pipette Graduated

SER5003218	A Grade - 1ml	Each	\$5.95	10 or more - \$5.25
SER5003219	A Grade - 2ml	Each	\$2.95	10 or more - \$2.75
SER5003220	A Grade - 5ml	Each	\$2.95	10 or more - \$2.75
SER5003221	A Grade - 10ml	Each	\$6.95	10 or more - \$6.25
SER5003222	A Grade - 20ml	Each	\$9.95	10 or more - \$8.95
SER5003223	A Grade - 25ml	Each	\$9.95	10 or more - \$8.95
SER5003224	A Grade - 50ml	Each	\$6.95	10 or more - \$6.25



SER1052470	B Grade - 1ml	Each	\$2.95	10 or more - \$2.75
SER1052471	B Grade - 2ml	Each	\$2.95	10 or more - \$2.75
SER1052459	B Grade - 5ml	Each	\$4.95	10 or more - \$4.50
SER1052460	B Grade - 10ml	Each	\$4.95	10 or more - \$4.50
SER1052461	B Grade - 25ml	Each	\$5.95	10 or more - \$5.25
SER1052487	B Grade - 50ml	Each	\$5.95	10 or more - \$5.25



### Glass Volumetric Pipette

Guaranteed Premium Quality.

- Used in chemistry, pharmacy, health, biology and food applications
- Permanent Markings
- Dishwasher Safe
- Made in Europe

SER5003217	A Grade - 1ml	Each	\$9.95	10 or more - \$8.95
SER5003216	A Grade - 2ml	Each	\$10.95	10 or more - \$9.95
SER5003215	A Grade - 5ml	Each	\$11.95	10 or more - \$10.95
SER5003214	A Grade - 10ml	Each	\$12.95	10 or more - \$11.95
SER5003213	A Grade - 15ml	Each	\$13.95	10 or more - \$12.95
SER5003210	A Grade - 25ml	Each	\$14.95	10 or more - \$13.95
SER5003211	A Grade - 50ml	Each	\$19.95	10 or more - \$17.95



SER1052484	B Grade - 1ml	Each	\$3.95	10 or more - \$3.50
SER1007125	B Grade - 2ml	Each	\$3.95	10 or more - \$3.50
SER1052462	B Grade - 5ml	Each	\$3.95	10 or more - \$3.50
SER1052463	B Grade - 10ml	Each	\$4.95	10 or more - \$4.50
SER1016245	B Grade - 20ml	Each	\$5.95	10 or more - \$5.25
SER1052464	B Grade - 25ml	Each	\$6.95	10 or more - \$6.25
SER1052488	B Grade - 100ml	Each	\$7.95	10 or more - \$7.25



Test Tubes without Rim

SER1007117	10 x 75mm	Pack 100	\$19.95
SER5003067	12 x 75mm	Pack 100	\$169.95
SER5003066	20 x 150mm	Pack 100	\$199.95
SER1007118	24 x 150mm	Pack 50	\$129.95
SER1016142	13 x 100mm	Pack 100	\$39.95
EIS0725WR	25 x 250mm	Pack 24	\$30.95
EIS0716WR	16 x 150mm	Pack 48	\$25.95
EIS0718WR	18 x 150mm	Pack 24	\$15.95
SER5003063	A Grade - 16 x 150mm	Pack 100	\$199.95

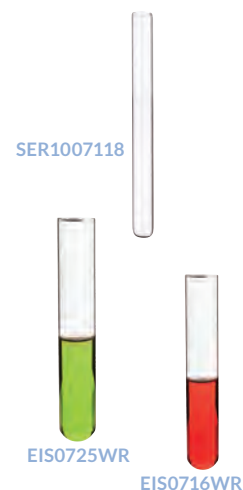

Test Tubes with Rim

SER1016045	10 x 75mm	Each	\$29.95
SER1007067	24 x 200mm	Each	\$98.95
SER5003069	A Grade	Pack 100	\$169.95
SER5003071	A Grade - 160 x 150mm	Pack 100	\$199.95
SER5003073	A Grade - 18 x 150mm	Pack 50	\$129.95
SER5003074	A Grade - 24 x 150mm	Pack 50	\$149.95
EIS0725R	25 x 250mm	Pack 24	\$30.95
EIS0716R	16 x 150mm	Pack 48	\$25.95
EIS0718R	18 x 150mm	Pack 24	\$15.95

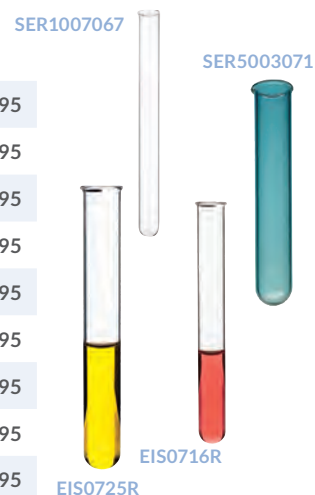

Borosilicate Test Tubes with Rim

SER1052425	16 x 150mm	Pack 100	\$81.95
SER1052422	18 x 150mm	Pack 100	\$89.95



B Grade Test Tubes

SER1007127	16 x 150mm	Pack 100	\$77.95
SER1007115	12 x 100mm	Pack 100	\$39.95
SER1007068	25 x 150mm	Pack 100	\$119.95
SER1052423	Graduated - 18 x 180mm	Pack 100	\$99.95
SER1052427	With Side Arm - 25 x 200mm	Pack 10	\$22.95



## Test Tubes & Tubing

### A Grade Test Tubes

SER1052426	Side Arm – 18 x 150mm	Pack 10	\$15.95
SER1007119	Side Arm 21 x 180mm	Pack 10	\$19.95



SER1052426

### Borosilicate Test Tubes

SER1052491	Writable – 18 x 150mm	Pack 100	\$73.95
------------	-----------------------	----------	---------



SER1052491

### Test Tubes with Screw Cap

EIS0724-12	5 x 150mm	Pack 12	\$22.95
EIS0724-24	16 x 125mm	Pack 24	\$33.95

EIS0724-12



EIS0724-24

### Borosilicate Tubing

SER5003901	T11 x 22mm – 1500mm	Each	\$11.95
SER5003903	T13 x 22mm – 1500mm	Each	\$11.95

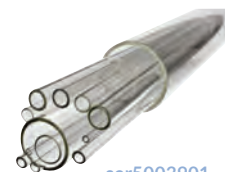

ser5003901

### Borosilicate Glass Tubing

EIS747B	5mm, length 0.5mtr	Pack 10	\$19.95	10 or more – \$17.95
EIS747C	6mm, length 0.5mtr	Pack 10	\$19.95	10 or more – \$17.95
EIS747D	7mm, length 0.5mtr	Pack 10	\$21.95	10 or more – \$19.95
EIS747E	8mm, length 0.5mtr	Pack 10	\$21.95	10 or more – \$19.95
EIS747F	9mm, length 0.5mtr	Pack 10	\$21.95	10 or more – \$19.95
EIS747G	10mm, length 0.5mt	Pack 10	\$21.95	10 or more – \$19.95
EIS747H	12mm, length 0.5mt	Pack 10	\$23.95	10 or more – \$21.95
EIS747I	14mm, length 0.5mt	Pack 10	\$23.95	10 or more – \$21.95
EIS747J	16mm, length 0.5mt	Pack 10	\$23.95	10 or more – \$21.95
EIS747K	18mm, length 0.5mt	Pack 10	\$24.95	10 or more – \$22.95
EIS747L	20mm, length 0.5mt	Pack 10	\$24.95	10 or more – \$22.95
EIS747M	25mm, length 0.5mt	Pack 10	\$24.95	10 or more – \$22.95

## Plasticware Classroom Value Kit

Stock up on your most used plasticwares with this value pack!

### EISKIT3

#### Kit includes

- 50 graduated beakers in 5 volumes
- 30 graduated measuring jugs in 3 volumes
- 70 graduated cylinders in 7 volumes
- 15 wash bottles in 3 volumes

\$757.95



~~\$797.75~~  
**\$757.95**  
Save \$39.80



### Measuring Containers

Set of 18 measuring containers with wide mouths for easy measuring. The set contains 10 x 100ml, 5 x 200ml, 2 x 500ml and 1 x 1 litre containers.

DM1033

18 pieces \$46.95

## Polypropylene Graduated Beakers with Raised Measurements

EIS0137A	50ml	Each	\$1.95	10 or more - \$1.75
EIS0137B	100ml	Each	\$2.30	10 or more - \$2.10
EIS0137C	250ml	Each	\$2.40	10 or more - \$2.20
EIS0137D	500ml	Each	\$3.65	10 or more - \$3.25
EIS0137E	1000ml	Each	\$8.95	10 or more - \$7.95



## Polypropylene Graduated Beakers

These graduated beakers are great for use in a lab where glass is either not required or there is a high chance of breakages.

SER1013008	10ml	Each	\$1.00	10 or more - \$0.90
SER1013009	25ml	Each	\$1.10	10 or more - \$1.00
SER1013010	50ml	Each	\$1.50	10 or more - \$1.30
SER1013011	100ml	Each	\$1.95	10 or more - \$1.75
SER1013012	250ml	Each	\$2.95	10 or more - \$2.50
SER1013013	500ml	Each	\$4.95	10 or more - \$4.25
SER1013014	1000ml	Each	\$5.95	10 or more - \$5.25
SER1013015	2000ml	Each	\$9.95	10 or more - \$8.95



## TPX Clear Graduated Beakers

These beakers are made from TPX and are ideal for minimising the risk of breakages.

SER1013057	10ml	Each	\$3.50	10 or more - \$3.25
SER1013056	25ml	Each	\$2.95	10 or more - \$2.75
SER1013055	50ml	Each	\$3.95	10 or more - \$3.50
SER1013054	100ml	Each	\$5.95	10 or more - \$5.25
SER1013053	250ml	Each	\$8.40	10 or more - \$7.75
SER1013052	500ml	Each	\$9.40	10 or more - \$8.50
SER1013051	1000ml	Each	\$12.95	10 or more - \$11.50
SER1013050	2000ml	Each	\$19.95	10 or more - \$17.95



SER1013050

## Bottles

### Wash Bottles

Polyethylene, translucent and unbreakable. Graduated wash bottles with removable nozzles. These bottles are graduated on the outer surface to give an approximation of the volume of solution filled or dispensed.

SER1012025	LDPE Removable Jet – 250ml	Each	\$2.95
SER1012026	LDPE Removable Jet – 500ml	Each	\$3.50
SER1008008	LDPE Fixed Spout 250ml	Each	\$4.50
SER1008066	LDPE Fixed Spout 500ml	Each	\$4.95



EIS0180B	Polyethylene – 250ml	Each	\$3.05	10 or more – \$2.95
EIS0180A	Polyethylene – 125ml	Each	\$2.35	10 or more – \$1.95
EIS0180C	Polyethylene – 500ml	Each	\$4.70	10 or more – \$4.50
EIS0180K	Polyethylene – Set of 3	Each	\$9.95	



### Polypropylene Reagent Bottles

The bottles are suitable for universities and industrial laboratories. The bottles are leak-proof and can be autoclaved.

SER1008045	Narrow Mouth Screw Cap – 60ml	Each	\$1.95	10 or more – \$1.75
SER1008046	Narrow Mouth Screw Cap – 125ml	Each	\$2.95	10 or more – \$2.75
SER1008042	Narrow Mouth Screw Cap – 250ml	Each	\$2.95	10 or more – \$2.75
SER1008048	Narrow Mouth Screw Cap – 500ml	Each	\$3.95	10 or more – \$3.50
SER1008049	Narrow Mouth Screw Cap -1000ml	Each	\$8.50	10 or more – \$7.50



SER1008042

SER1008055	Wide Mouth Screw Cap – 60ml	Each	\$1.25	10 or more – \$1.00
SER1008061	Wide Mouth Screw Cap – 125ml	Each	\$1.75	10 or more – \$1.50
SER1008057	Wide Mouth Screw Cap – 250ml	Each	\$2.95	10 or more – \$2.75
SER1008058	Wide Mouth Screw Cap – 500ml	Each	\$3.50	10 or more – \$3.10
SER1008059	Wide Mouth Screw Cap – 1000ml	Each	\$8.95	10 or more – \$7.95



SER1008058

EIS0172C	250ml	Each	\$3.25	10 or more – \$2.95
EIS0172D	500ml	Each	\$4.15	10 or more – \$3.95
EIS0172B	125ml	Each	\$3.15	10 or more – \$2.95



EIS0172B

EIS0172C



## Burettes, Pipettes &amp; Funnels

**Disposable  
Pipette – 3ml**

Illustrated beaker not included.

**EIS0005** Each **\$0.95**  
**EIS0005K** Set of 10 ~~\$9.50~~ **\$7.95**

 Set of 10  
 Save  
**\$155**

 Set of  
**6**
**Giant Pipettes**

Made of durable quality-moulded plastic and perfect for little hands. Set of 6 pipettes.

**EC0006** Set of 6 **\$10.95**

**Acrylic Burette with Stopcock**

These burettes are made from hard-to-break acrylic with a leak-proof PTFE stopcock. Resistant to dilute minerals, acids bases, except hydrofluoric acid and ammonium hydroxide.

**SER1008019** 25ml x 0.1ml **\$16.95**  
**SER1008014** 50ml x 0.1ml **\$21.95**  
**SER1008018** 100ml x 0.1ml **\$29.95**

**SER1014191**
**Transfer Pipette**

High quality polyethylene pipettes

**SER1014191** 1ml x 0.25ml – Pack of 500 **\$19.95**  
**SER1016020** 3ml x 0.5ml – Pack of 100 **\$22.95**  
**SER1014195** Thin Stem – Pack of 500 **\$79.95**

**Funnels**

These funnels are unaffected by dilute acids and alkalies.

<b>SER1008012</b>	Buchner Funnel – Poly 70mm	Each	<b>\$9.95</b>	10 or more – <b>\$8.95</b>
<b>SER1008012B</b>	Buchner Funnel – Poly 110mm	Each	<b>\$11.95</b>	10 or more – <b>\$10.95</b>
<b>SER1014801</b>	Burette Funnel – Poly 50mm	Each	<b>\$0.95</b>	10 or more – <b>\$0.75</b>



<b>SER1013034</b>	Polypropylene Long Stem Filter Funnel – 50mm	Each	<b>\$1.35</b>	10 or more – <b>\$1.20</b>
<b>SER1013035</b>	Polypropylene Long Stem Filter Funnel – 75mm	Each	<b>\$1.95</b>	10 or more – <b>\$1.75</b>
<b>SER1013036</b>	Polypropylene Long Stem Filter Funnel – 100mm	Each	<b>\$26.95</b>	10 or more – <b>\$23.95</b>
<b>SER1013032</b>	Polypropylene Short Stem Filter Funnel – 100mm	Each	<b>\$2.95</b>	10 or more – <b>\$2.50</b>



<b>EIS0454A</b>	Polythene Funnels Kit – 5cms	Each	<b>\$1.95</b>	10 or more – <b>\$1.85</b>
<b>EIS0454C</b>	Polythene Funnels Kit – 7.5cms	Each	<b>\$2.05</b>	10 or more – <b>\$1.95</b>
<b>EIS0454D</b>	Polythene Funnels Kit – 10cms	Each	<b>\$2.50</b>	10 or more – <b>\$2.25</b>
<b>EIS0454K</b>	Polythene Funnels Kit – Set of 3	Each	<b>\$5.95</b>	



<b>SER1008009</b>	Polypropylene Powder Funnel – 65mm	Each	<b>\$2.80</b>	10 or more – <b>\$2.50</b>
<b>SER1008010</b>	Polypropylene Powder Funnel – 80mm	Each	<b>\$3.50</b>	10 or more – <b>\$3.25</b>
<b>SER1008013</b>	Polypropylene Powder Funnel – 150mm	Each	<b>\$4.50</b>	10 or more – <b>\$3.95</b>



<b>SER1008193</b>	Polypropylene Pear Separating Funnel – 250ml	Each	<b>\$14.95</b>	10 or more – <b>\$13.95</b>
-------------------	--	------	----------------	-----------------------------



## Measuring Equipment

### Polypropylene Measuring Jugs

These polypropylene jugs are autoclavable and have good chemical resistance. The jugs have handles for easy and convenient lifting.

SER1008098	Metric – 250ml	Each	\$7.50	10 or more – \$6.75
SER1008099	Metric – 500ml	Each	\$7.95	10 or more – \$6.95
SER1010429	Metric – 1000ml	Each	\$8.95	10 or more – \$7.95
SER1010430	Metric – 2000ml	Each	\$9.95	10 or more – \$8.95



SER1010429

EIS0356A	Graduated Measuring Jug – 250ml	Each	\$3.00	10 or more – \$2.75
EIS0356B	Graduated Measuring Jug – 500ml	Each	\$4.25	10 or more – \$4.00
EIS0356C	Graduated Measuring Jug – 1000 ml	Each	\$4.80	10 or more – \$4.50
EIS0356DM	Graduated Measuring Jug – 2000ml	Each	\$5.85	10 or more – \$5.25
EIS0356K	Graduated Measuring Jugs – Set of 3	Each	\$10.95	

EIS0356C



EIS0356B

EIS0356A

### Polypropylene Cylinders

Polypropylene measuring cylinders with moulded markings.

SER1012030	Measuring Cylinder – 10ml	Each	\$2.10	10 or more – \$1.95
SER1012031	Measuring Cylinder – 25ml	Each	\$3.10	10 or more – \$2.85
SER1012032	Measuring Cylinder – 50ml	Each	\$3.70	10 or more – \$3.35
SER1012033	Measuring Cylinder – 100ml	Each	\$4.95	10 or more – \$4.25
SER1012034	Measuring Cylinder – 250ml	Each	\$6.70	10 or more – \$5.95
SER1012035	Measuring Cylinder – 500ml	Each	\$8.95	10 or more – \$7.95
SER1012036	Measuring Cylinder – 1000ml	Each	\$18.95	10 or more – \$16.95
SER1012037	Measuring Cylinder – 2000ml	Each	\$24.95	10 or more – \$21.95



SER1012030

SER1012033

SER1012037

EIS0354A	Graduated Cylinder – 10ml	Each	\$2.00	10 or more – \$1.80
EIS0354B	Graduated Cylinder – 25ml	Each	\$2.25	10 or more – \$2.00
EIS0354C	Graduated Cylinder – 50ml	Each	\$2.70	10 or more – \$2.50
EIS0354D	Graduated Cylinder – 100ml	Each	\$4.00	10 or more – \$3.60
EIS0354E	Graduated Cylinder – 250ml	Each	\$9.40	10 or more – \$8.75
EIS0354F	Graduated Cylinder – 500ml	Each	\$5.85	10 or more – \$5.35
EIS0354G	Graduated Cylinder – 1000ml	Each	\$11.95	10 or more – \$10.95
EIS0354K	Graduated Cylinders – Set of 7	Each	\$36.95	



EIS0354K

## Syringes &amp; Weighing Trays

## Plastic Syringes

These are a standard type disposable syringe. These are high quality, latex-free syringes featuring clear barrels. The integrated plunger stop helps prevent the plunger from being pulled out accidentally. Bold markings and graduations allow quick visual checking for precise dosage.

SER1016017	Non-Sterile Luer Slip – 3ml	Each	\$0.40	10 or more – \$0.30
SER1016002A	Non-Sterile Luer Slip – 10ml	Each	\$0.50	10 or more – \$0.40
SER1016003	Non-Sterile Luer Slip – 20ml	Each	\$0.50	10 or more – \$0.40
SER1016004	Non-Sterile Luer Slip – 50ml	Each	\$1.50	10 or more – \$1.20
SER1016002	Sterile Luer Slip – 10ml	Pack 100	\$49.95	
SER1016009	Sterile Luer Slip – 30ml	Pack 50	\$79.95	
SER1016004A	Sterile Luer Slip – 60ml	Pack 25	\$36.95	
EIS0356F	Plastic Syringes – 50ml	Pack 10	\$19.95	
EIS0356D	Plastic Syringes – 10ml	Pack 10	\$3.95	
EIS0356E	Plastic Syringes – 20ml	Pack 10	\$15.95	



## Plastic Luer Lock Syringe Cap

These caps are ideal to contain the liquid at the dispensing end.

SER1016000A	60ml	Pack 10	\$99.95
-------------	------	---------	---------



SER1016000A

## Polypropylene Wide Screw Cap Conical Flask

SER1008095	250ml	Each	\$4.95	10 or more – \$4.50
------------	-------	------	--------	---------------------



## Polypropylene Weighing Trays

These trays are perfect to store, dispense and weigh materials.

SER1014458	44 x 44 x 8.5mm – 7ml	Pack of 1000	\$269.95
SER1014428	80 x 80 x 24mm – 100ml	Pack of 1000	\$119.95
SER1014464	134 x 134 x 24mm – 250ml	Pack of 50	\$49.95
SER1014433	134 x 134 x 24mm – 250ml	Pack of 1000	\$599.95



SER1014428

Essentials



**Transparent Desiccator**

These desiccators are ideal for preserving moisture-sensitive chemicals and items.

SER1013020 150ml \$49.95  
 SER1013021 250ml \$129.95

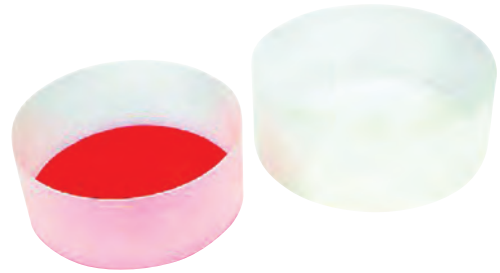

**Autoclavable Pneumatic Trough**

The trough is autoclavable and can be used for storage and sterilising. Diameter: 25cm. Height 10 cm

SER1069023 \$18.95



**Disposable Sterile Petri Dish**

Plastic petri dishes with safety lids for chemicals and also biological experiments.

SER1007106A 90x15mm - Pack of 500 \$115.95  
 SER1007108 120 x 25mm - Pack of 10 \$13.95



**Petri Dish**

Plastic petri dish for studying microbes. Illustrated bugs not included.

NK50804 9cm - 100 Pack \$37.95  
 NK50068 9cm - 20 Pack \$7.95  
 NK6605-25 7cm - 25 Pack \$16.25 \$15.95



**Screw Cap Specimen Container**

Specimen containers for the collection of biological specimens such as urine, sputum and tissue. They are also ideal for storage and water sampling. 27 x 70mm

SER1230008 30ml - Pack of 1000 \$229.95  
 SER1230001 30ml - Pack of 550 \$169.95



**Screw Cap Specimen Tube**

Specimen tubes for the collection of biological specimens such as urine, sputum and tissue. They are also ideal for storage and water sampling. 15 x 97mm

SER1230009 10ml \$256.95  
 SER1016046 25ml \$199.95



**Jumbo Test Tubes and Stand**

These 100ml test tubes support investigation and hands-on observation. Plastic tubes are safe from -10 to 95°C. Set of 6 test tubes. Tubes measure 15 x 3.8cm in diameter.

LER2788 \$29.95



\$286.85  
**\$259.95**  
 Save \$26.90



**Stopwatch Classroom  
 30 Pack with Storage**

A complete class set of 30 stopwatches! This kit also conveniently includes a deep Gragnells Tray with lid, as well as a foam insert to hold 30 stopwatches.

TFC10724K \$259.95

Save  
**\$405**



**Stopwatches**

The hand held stopwatches come with thumb and forefinger control. Accurate to 1/100 of a second. Features split/lap time, 12 and 24 hour time, alarm, date functions and a handy wrist/neck strap. Stop watch is water resistant.

TFC10726 Pack of 10 \$77.95



**Solar  
 Powered Stopwatches**

Hand held stopwatches with thumb and forefinger control. Accurate to 1/100 of a second. Features split/lap time, 12 and 24 hour time, alarm, date functions and a handy wrist/neck strap. Water resistant. Class pack of 10.

TFC16076K Set of 10 \$159.95



Save  
**\$1955**



**Stopwatch - Digital, Economy**

1/100 Sec, Date, Time, Alarm, Replacement battery is A76 Battery.

SER1026001 \$11.95



**Stopwatch - Digital, Waterproof**

Stopwatch - Digital, Waterproof. Want a stopwatch that ONLY Times, No beeps etc . We have had many requests for a simple operation stopwatch, so...we delivered!

SER1027007 \$29.95



**Mechanical Stopwatch**

Stopclock type. Mechanical 60m x 1sec. Mechanical (wind up). Two sweep hands, seconds/minutes. 24 hour. 100mm dial. 0-60 x 1min.

SER1010014 Set of 10 \$39.95

## Thermometers



### Red Spirit Partial Immersion Thermometer - 300mm

Red Spirit, 300mm length, -10 to +110°C x 1.0 increments, 76mm immersion.

SER1028003 \$4.95



### Red Spirit Partial Immersion Thermometer - 305mm

Red Spirit, 305mm length, -10 to +50°C x 0.5 increments, 76mm immersion.

SER1028002 \$5.95



### Red Spirit Immersion Thermometer - 205mm

Red Spirit, 205mm length, -10 to +110°C x 1.0 increments, 76mm immersion, anti-roll top.

SER1028015 \$4.95



### Red Spirit Immersion Thermometer - 300mm

Red spirit, -10 to +110°C, 76mm immersion, made in China.

SER1052596 \$2.60



### Green Spirit Immersion Thermometer - 300mm

Green spirit, 300mm length, -10 to +110°C, 76mm immersion, triangular anti-roll top.

SER1028001 \$4.95



### Low Range Thermometer - 305mm

Thermometer - low range, total immersion, -100/50, 305mm.

SERGE5235-01 \$69.95



### Low Tox Thermometer - 305mm

Filled with low tox organic filling, non-hazardous and fitted with non roll cap with ring for hanging.

SER1028028 \$14.95



### Environmentally Friendly Thermometer

Measuring range -20°C to +110°C x 1°. Must be completely immersed for accuracy. Anti-roll device also included.

NK50032 \$4.95



### Student Thermometers

A set of 12 glass student thermometers on a PVC base. The thermometers range from -40 to +50 degrees Celsius. The thermometers measure 15cm approximately and do not contain any mercury.

EIS1200 \$29.95



### Thermometer

This thermometer is ideal for the measurement of the temperature of liquids. It is an organic alcohol-filled instrument that measures a temperature range between 10°C and 100°C, and features a white back and 1 degree divisions for reading ease.

NK0906 \$3.25  
10 or more Each \$2.30



### Thermometer Electronic

This thermometer can offer an accurate temperature without being placed in the mouth. 12cm in length.

This thermometer is powered by a button cell battery. This is a medical device and not a toy, it is not intended for unsupervised use by children.

DC50590 \$22.95



### Clinical Glass Thermometer

Easy to use clinical thermometer with red tritop, white back and subnormal temperature range of 35 to 42 degrees celcius. Can be used for oral, rectal, and underarm measurement of body temperature.

SER1016066 \$3.95



**Digital Thermometer – 145mm Stem**

145mm stem, -45 to 150 x 0.1°C. Screen size: 30x8mm. Has auto power off function to preserve battery. Will hold the reading for reference. Instruction sheet included.

SER1152002 \$19.95



**Thermocouple Thermometer – 2 Input**

Fast response and laboratory accuracy, works with K-type thermocouples and offers 0.1 or 1°C user-selectable resolution over the entire measurement range. Specifications: Display: 2000 count, basic accuracy: 0.5%, range: -50 to +1300°C (-58 to +2000°F), dimensions: 172(H) x 84(W) x 42(D)mm.

SER1137080 \$130.95



**Thermocouple Thermometer Probe**

This plug in thermocouple probe allows you to measure external temperature readings on DMMs. Will measure temperatures from below -50° to over 1200°C. Actual range depends on the DMM it is used with. Suitable for use in gas and liquid, both with very good accuracy. -40°C to 900°C accuracy, 2.5°C or 0.75°C of temperature.

SER1137080A \$21.95



**Laser Targeting Thermometer (Non Contact)**

With an 11:1 distance to spot size, you can get the temperature of almost the exact spot in most cases. Holster included. Specifications: response time: <150ms, temperature range: -50 to +650°C (-58 to +1202°F), optical resolution: 11:1, accuracy: +/-1% of reading, laser output: <1mW, dimensions: 140(L) x 104(W) x 43(H)mm.

SER1024121 \$159.95



**Jumbo Display Thermometer Hygrometer**

Displays the temperature and humidity together on the one huge LCD display. It also has a min / max function (memory). Switch between °C and °F. Requires AAA battery. Temperature: -10°C to 60°C (14°F – 140°F), humidity: 10 – 99%, accuracy: -1°C, -1.8°F, size: 135(H) x 100(W) x 22(D)mm.

SER1137029 \$32.95



**Mercury Thermometer – -10 to +360°C**

Produced in the UK, with no compromise in quality or accuracy. They feature a moulded glass triangular top to prevent rolling. Mercury thermometer, -10°C to +360°C x 2.0°C, 76mm immersion, 300mm length.

SER1052968 \$5.95



**Student Thermometer -50 – 110°C**

Unlike non-plastic thermometers, possible to immerse in hot liquid without the danger of burning students' hands. The tubes of these 16.5cm, red alcohol thermometers made of recessed-moulded plastic to prevent breakage, Range of -50°C to +110°C.

QE95570 \$4.95



**Minimum Maximum Thermometer**

This wall mountable, indoor or outdoor thermometer is a must for all schools. Accurate and easy to read, this thermometer is for measuring maximum as well as minimum temperatures. Also features a simple reset push-button. Range from 40°C to +50°C.

NK50033 \$16.95



**Non Mercury Push Button Thermometer**

Push the button to reset the temperature reading. This thermometer is in a tough moulded plastic case and holds the max/min temperature from reset to reset.

SER1028024 \$19.95

## Thermometers



### Thermometer Room Classroom

This wall mounted thermometer clearly features both Celcius and Farenheit scales. Recessed tube prevents breakage. Range: -40°C to +50°C and -40°F to +120°F. Measures 36.5 x 7.5cm.

TFC11851

\$10.95



### Thermometer - Wall Mountable, Large, -45/+50

Thermometer - Wall Mountable, Large, -45/+50, Dimensions: 380cm x 6.5cm

SER1052225

\$11.95



### Thermometer - Wall Mountable, Large, -45/+50

Thermometer - Wall Mountable, Large, -45/+50, Dimensions: 380cm x 6.5cm

SER1028013

\$4.95



### Metal Soil Thermometer -10 to +60°C

This thermometer is in a metal case with a viewing slot and knob to push into the soil with the pointed end. Approximately 330mm long.

SER1028020

\$18.95



### Indoor-Outdoor Thermometer

Compare indoor and outdoor temperatures and found out what the humidity is with this thermo-hygrometer. Includes a 1.5 metre temperature probe which will have to be positioned outside. The temperature range: Indoor from -10 to 60&deg;C Outdoor: from -40 to 70&deg;C. Indoor hygrometer range: 20%RH to 98%RH. Requires 1 AAA battery (not included).

NK0416

\$19.95



### Digital Thermometer

Digital thermometer with one display that shows both the inside and outside temperatures simultaneously. It will also record the minimum and maximum temperatures. The outside temperature sensor is waterproof and is on a 3 metre cable.

EL7310

\$31.95



### Spare Non Roll Rubber Thermometer Tip

These tips go on the end of your thermometers, allowing them to be hung and also preventing them rolling along your benches.

SER1014151

\$0.50



### Plastic Thermometer Case

This plastic thermometer case can be adjusted to fit all sizes. Made simply from plastic as a sheath to protect your delicate thermometers!

SER1035905

\$1.10



### Thermometer Clips

These thermometer clips keep the thermometer upright when attached to a beaker or a flask.

SER1052226

\$3.95



Set of 10  
Save  
**\$8955**



**Features**

- 360 functions for more advanced equations and maths/science subjects
- Auto on/off function
- Durable plastic keys
- Graphic functions (rectangular coordinate graph/statistical graph)
- Graph analysis functions (trace/plot/line/zoom/scroll)



**Graphic Scientific Calculator**

This Graphic Scientific calculator is a powerful yet affordable device to visualise all equations and graphs. This calculator has all the normal functions of a scientific calculator making it perfect for any high school class.

CEC121 Each \$34.95  
CEC121-10 Set of 10 \$259.95

Set of 10  
Save  
**\$1955**

*Calculate more complex equations*



**Scientific Calculator – Basic**

This kit includes 10 basic scientific calculators. These calculators are perfect for introducing students to the scientific calculators. It is basic and easy to use with most of the functions of a normal scientific calculator and not so much of an intimidating look.

TFC11660-10 Set of 10 \$109.95

Set of 10  
Save  
**\$955**

*Ideal for advanced maths problems*



**Scientific Calculator – 2 line**

This calculator allows students to spend less time on tedious calculations and more time on understanding and solving problems.

TFC11661-10 Set of 10 \$159.95

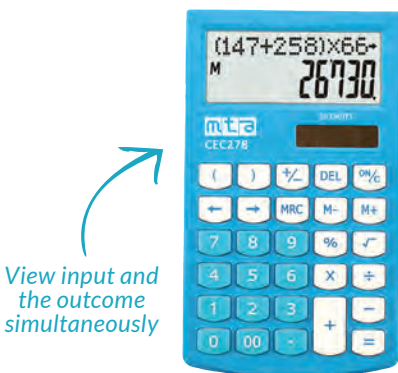

*View input and the outcome simultaneously*

Set of 30 + Book  
**\$29995**  
—  
Save \$61.50

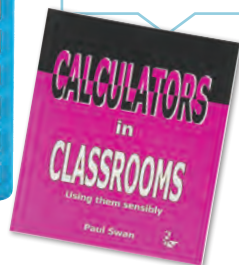

**Two Line Calculator – 10 Digits**

The two line calculator makes it possible to view the input and answers at the same time.

CEC278 Each \$10.95  
CEC278K Set of 30 & Book \$299.95

**Key Features:**

View input and answer simultaneously; Robust and durable design; perfect for classroom use; Dual Powered



\$519.45  
**\$39995**  
—  
Save \$119.50



**30 Calculators & Tray**

The large keys on these high quality, solar-powered desk top calculators provide easy operation and the titled 12-digit display shows easy-to-read characters.

TEB908K Set of 30 \$399.95

## Burners &amp; Accessories

**Bunsen Burner with Flame Stabilizer**

This bunsen burner is suitable for use in combination with LPG. It is equipped with a serrated inlet for connection to 6-8mm tubing. Air supply is controlled by a nickel plated brass sleeve covering ports at the lower end of the mixing tube.

EIS0093H

\$27.95

**LPG Bunsen Burner**

This LPG Bunsen burner has a heavy diecast base and nickel plated brass tube and air regulator. Side tube, 10mm diameter for gas tubing connection.

SER1010461

\$15.95

**Natural Gas Bunsen Burner**

This natural gas Bunsen burner has a heavy diecast base and nickel plated brass tube and air regulator. Side tube, 10mm diameter for gas tubing connection. Jet size correct for 'natural gas' operation. This is the most common gas used in Australia.

SER1010462

\$19.95

**Stainless Steel Bunsen Burner Flame Spreader**

This stainless steel Bunsen burner flame spreader is suitable for SER10110461 and SER1010462.

SER1020046

\$7.95

**Natural Gas Bunsen Burner Flame Stabiliser**

This burner is suitable for use in combination with natural gas. The aluminium burner mixing tube comes complete with a brass flame stabiliser. It is equipped with a serrated inlet for connection to 6-8mm tubing.

EIS0093H-NG

\$27.95

**Natural Gas Bunsen Burner with Safety Handle**

The Bunsen burner is designed for use with natural gas. It is designed to prevent easy tipping even when the hoses are connected. The carry handle makes it possible to move the hot burner with ease and safety.

EIS0093QP-NG

\$27.95

Buy Kit  
Save  
**\$205**

**Bunsen Burner Start Up kit**

This kit consists of one bunsen burner (EIS0093H), one rubber tubing for the bunsen burner (EIS0100A), a wire gauze (NK1502) and a tripod stand (EIS0645A). The burner which can be used in combination with LPG is equipped with a serrated inlet for connection to 6-8mm tubing. The tripod offers good stability and easy access. The wire gauze comes with a ceramic centre for an even distribution of heat.

EIS0093K

LPG \$51.95

EIS0093K2

Natural Gas \$51.95

EIS0093BTN

Rubber Tubing Kit \$39.95





**Bunsen Burners Rubber Neoprene Tubing 600mm**

This silicon rubber tubing is ideal for use with the Bunsen burners. This tubing is supplied with reinforced ends for easy and sturdy connection with Bunsen burners and to gas taps on lab benches. The burner tube is made of neoprene rubber. The excellent long lasting quality tubes can be used with all types of gases. The internal diameter of tubing 5 mm and it can accept Bunsen burner diameters of up to 8 mm. The total length of the silicon rubber tubing is 60 cm. The tubing can also be used with atirill or any other type of burner to a fuel source. Simply connect the tube to your gas source and Bunsen burner to start experimenting!

EIS0100A

\$13.95

**Bunsen Burner LPG  
- No Tip & Safety Handle**

This new Bunsen burner is ideal for school labs. The Bunsen burner is designed for use with LPG. The burner comes with an expanded base, which prevents easy tipping, even when the hoses are connected. The spaced feet of the burner ensures that it fits comfortably under stands. Furthermore, the burner is designed with an easy carry handle. This makes it possible to move the hot burner with ease and safety by using the finger handle. Students won't burn their hands any longer!



EIS0093QP-L

\$27.95



**LPG Meker-Fisher Burner**

This is a laboratory burner that produces multiple open gas flames. Use this for heating, sterilisation and combustion. This is usually used when lab work requires a hotter flame than attainable using a Bunsen burner or when a larger diameter flame is required.

SER1010164

\$51.95



**Natural Gas Meker-Fisher Burner**

This is a laboratory burner that produces multiple open gas flames. Use this for heating, sterilisation and combustion. This is usually used when lab work requires a hotter flame than attainable using a Bunsen burner or when a larger diameter flame is required.

SER1010167

\$59.95



**Glass Spirit/Alcohol Burner - 100ml**

This spirit and alcohol burner has a 100ml capacity, and is supplied with a metal cap. Dimensions: 10cm height, 136 weight (including lid).

SER1012001

\$5.95



**Spare Wicks for Spirit/Alcohol Burner**

Feed tapered knotted end of the wick in from the bottom of the feeder tube. Pull through and out the top of tube measures approximately 20mm. Do not cut end off taper. Light knotted end when using new wick.

SER1012023

\$0.95

## Burners &amp; Accessories

**Wire Gauze**

The wire gauze has a ceramic composite intended to aid in the dispersal of heat. The wire gauze is centered on the ring stand as to allow the open flame to be in contact with it to a certain extent, depending on the desired heat. Asbestos free. 12.5cm square

NK1502

\$2.15

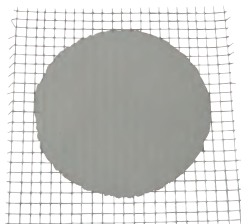
**Ceramic Centre Gauze Mat – 125 x 125mm**

Used on tripods to disperse heat from Bunsen burners. These stainless steel gauze mats are perfect for your laboratory. Measures 125 x 125mm.

SER1052327

\$2.95

**Ceramic Centre Gauze Mat – 150 x 150mm**

Used on tripods to disperse heat from Bunsen burners. These stainless steel gauze mats are perfect for your laboratory. Measures 150 x 150mm.

SER1010177

\$2.95

**Ceramic Centre Gauze Mat – 125 x 125mm**

Used on tripods to disperse heat from Bunsen burners. These stainless steel gauze mats are perfect for your laboratory. Measures 125 x 125mm.

SER1010176

\$3.95

**Stainless Steel Bent Edge Gauze Mat – 150 x 150mm**

Used on tripods to disperse heat from Bunsen burners. Bent edge to fit tripods to prevent sliding off or being lost. Measures 150 x 150mm.

SER1010176A

\$3.95

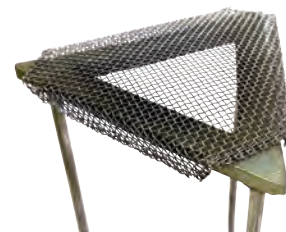
**Tripod Stand Triangular 21cm High**

This tripod stand will be a valuable resource in your science classroom. The tripod stand has splayed, steel legs for greater stability and easy access along with a cat iron top. The tripod stand is an excellent resource for use with a bunsen burner, wire gauze, beakers and evaporating basins. Each tripod is 12cm long and 21cm high.

EIS0645A

\$9.95

**Triangular General Tripod – 200 x 125mm**

General purpose tripod with sturdy construction. Measures 200H x 125W mm.

SER1019006

\$10.95

**Stainless Triangular Tripod – 200 x 125mm**

This stainless steel triangular tripod has welded joints, and rubber feet. Measures 200 x 125mm.

SER1212012

\$13.95

## Clamps & Retort Stands

### Clamps

These clamps are built with quality and strength in mind.

SER1042043	Clamp - G Type, 50mm	\$7.95
SER1042006	Clamp - G Type, 75mm	\$12.95
SER1051008	Clamp - G Type, 100mm	\$11.95
SER1042007	Clamp - G Type, 150mm	\$14.95
SER1042022	Clamp - G Type, 200mm	\$19.95
SER1020015	Clamp - Tubing (Mohr)	\$3.95
SER1010181A	Retort Clamp - 4 Claw, with Cork Liners	\$9.95
SER1010181	Retort Clamp - 4 Claw, with Rubber Coating	\$9.95
SER1020045	Clamp - Thermometer Holding	\$9.95
SER1020014	Clamp - Hoffman Tubing, Open 25mm	\$4.95
SER1008172	Burette Clamp - Poly, Single	\$5.95
SER1008145	Burette Clamp - Poly, Double	\$7.95
SER1019003	Burette Clamp - Double Fisher Style, Metal	\$12.95
EIS0687	Clamp Retort Combined	\$15.95
EIS0667A	Thermometer Clamp	\$7.50



\$75.50  
**\$71.95**  
 Save \$3.55



### Lab Essentials Retort Stand & Clamps Kit - Basic

A great starter pack for your science lab. This kit includes one of each: Retort stand with a base measuring 20 x 12.5cm and the rod measuring 60cm long and 11mm in diameter, a thermometer clamp, a retort clamp combined, a boss head, and a retort ring (7.5cm in diameter).

EISKIT1 \$71.95

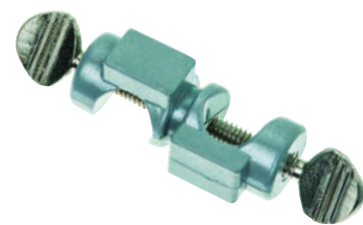
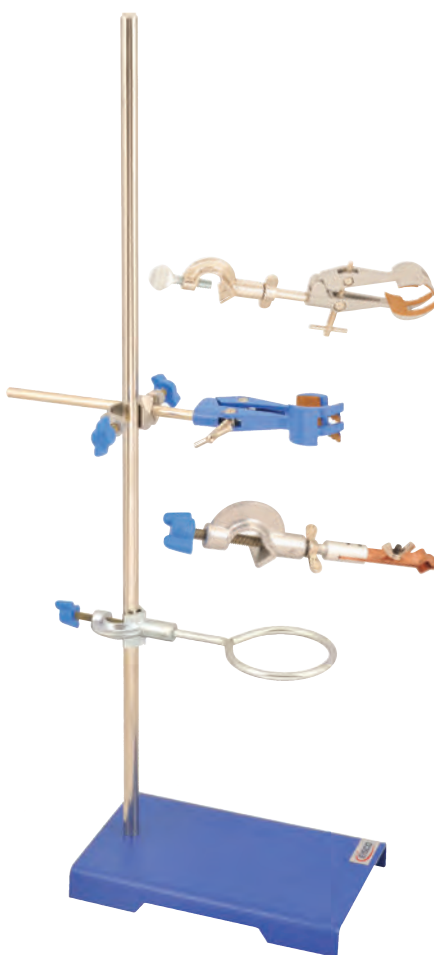

### Boss Head

For use with laboratory stand, diecast alloy, accepts rod up to 1.6cm diameter, which are secured with nickel-plated brass tommy screws.

EIS0662 \$4.75



### European Cross Clamp Bosshead

Alloy, cross clamp, European design, aluminium alloy with steel fastening screws. For 5-12mm diameter rods.

SER5003094 \$4.95

## Clamps, Retort Stands & Magnifiers

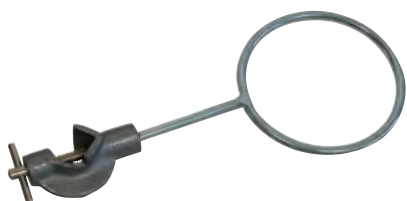

### Retort Ring – with Bosshead, Stainless

High quality retort rings.

- Bosshead included
- Stainless Steel

SER1010182	50cm	\$6.95
SER1010183	75cm	\$9.95
SER1010184	100cm	\$9.95



### Alloy Retort Stand

Alloy rod with 200 x 125mm steel base.

SER1010152	600mm Alloy Rod	\$19.95
------------	-----------------	---------



### Rectangular Retort Stand Base

Steel base with tapped hole 10 x 1.5mm metric thread in the centre of one short side. Fitted with rubber feet. Size: 20(L) x 12.5(W)cm, 1200g.

EIS0649B		\$27.95
----------	--	---------



SER1052321

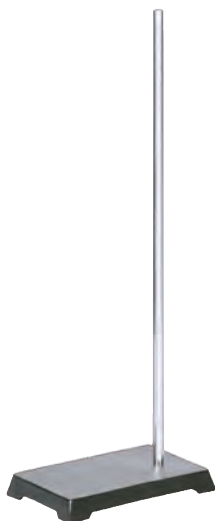

SER1010185

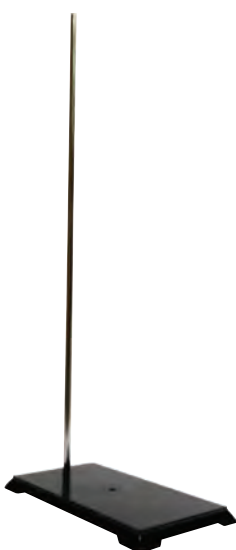

SER1010193

### Retort Stand

SER1052321	150 x 115mm Base, 450mm Rod	\$18.95
SER1010185	200 x 125mm Base, 600mm Rod	\$19.95
SER1010193	300 x 150mm Base, 750mm Rod	\$29.95

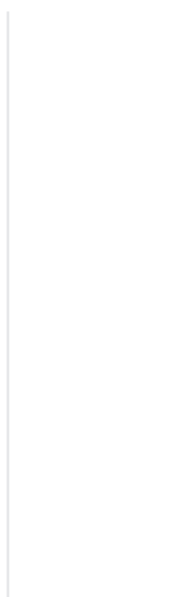

### Spare Rod for Retort Stand

Spare alloy rod.

SER1010152A	600mm	\$17.95
-------------	-------	---------



### Spare Tighting Base Nut for Retort Stand

SER1010185B	600mm	\$1.50
-------------	-------	--------



### Jewellers Folding Magnifier

These magnifiers are durable, strong and perfect for viewing.

SER1010270	\$5.95
------------	--------



### Giant Folding Magnifier

Hand held magnifier with 2x and 4x magnification. 100mm in diameter with additional spot lens. Strong rugged plastic handle moulded onto lens.

SER1153001	\$4.95
------------	--------



### Hand Magnifier – 2/4x

Giant folding magnifier which is easily held by small or large hands. Measures 50mm in diameter, and has 6x magnification.

SER1098003	\$4.10
------------	--------



**Foldable Magnifier**

Foldable magnifier with grid markings. Dimensions: 13Wx16Lx18H cm, magnification: 2.5x.

SER1153002 \$6.95



**Two-Way Microscope Magnifier**

Allows view of objective from the top and bottom.

SER1127006 \$7.95



5+ yrs

**Two-Way Bug Viewer - 4x**

The two way viewer allows you to observe your bug from the top as well as from the bottom. Great to watch with friends as two can view at one time! Fun for all ages! Comes with easy grip handles and plastic spider also included.

FD0201 \$19.95



**Eye Magnifier**

3X magnifier supports life science explorations looking at stamps, coins, plants or slides. Durable and super strong, sized perfectly for small hands. Viewing area measures 2.8(H) x 2.2cm diameter with a 4cm base diameter.

NK50721 \$8.95



**Magnifier Bi-Focal**

Solid plastic magnifying glass features both 3x (big lens) and 7x (small lens). Magnifier for a large or small scientific perspective. 11.5cm long, and suitable for ages 3 and up.

NK50136 Each \$1.95  
NK50136K Pack of 10 \$18.95



Set of 3 Save \$205

**Hand Magnifiers**

Securely set lens in plastic frame with an easy-to-grip handle. Smallest magnifier is 11cm long (3x and 8x), medium magnifier is 15cm long (3x and 6x), and the largest measures 19cm long (2x and 4x).

FD04000 Set of 3 \$19.95  
FD06036 3x & 6x - 15cm long \$10.95  
FD04038 3x & 8x - 11cm long \$6.95  
SER1098003 2/4x - 19cm long \$4.10



**Magnifier Bi-Focal**

For a large or small scientific perspective. Features both 3x big lens and a 7x small lens. Zero distortion while twice the fun. Suitable for ages 3 and up. 11.5cm(L). Supplied in a set of 30 Bi-Focal magnifiers, stored in a handy container.

TFC50042 Pack of 30 \$61.95

**Helping Hands Magnifier with Clip**

Ideal aid for PCB assembly, soldering work, model making and any application where a third hand is needed. This helping hand has a magnifying glass with LED light that provides continuous light for up to 10 hours. The two strong alligator clips can be adjusted in numerous ways to hold the board as you solder. Heavy cast iron base ensures added stability. Comes complete with a soldering iron holder, two white LED, lens size: 90mm (diameter), lens magnification: 2x, power: requires 3xAAA batteries. Dimensions: Overall height: 190mm x base dimensions: 114(L) x 75(W) x 29(H)mm.

SER1024092 \$26.95



## Magnifiers



### Folding Magnifier - 3/6x

Magnifier double lens folding pocket - 3x and 6x magnification.

SER1010271

\$4.95

Set of 30  
Save  
**\$390**



### Invicta - Bug Pots

Children will find the bug pots a useful addition to their study of nature. Can use the individual transparent pots with magnifying lids to observe findings. It comes complete with 5mm squared measuring grid in the base and 2.5x magnification in the lid. Allowing students to compare and measure the size of their creature without having to touch it. The bug viewers are an ideal resource to use to investigate nature and to explore the world around us: view bugs, insects, rocks, sand, and more from up close! The perfect resource to use on your field trip! Just make sure that the insects and specimens are released back into nature after observation. Each pot measures 4.5 x 5.2cm. The set supplied in a set of 10 bug pots. Ages 4+ years.

IP0401

Set of 10 \$29.95

IP0401-30

Set of 30 \$85.95



Set of 6  
Save  
**\$255**



### Bug Viewer

Children can have a closer look at all things small with this crystal clear plastic container with colourful edges and built in airholes. It has two high quality magnifying lids that focus by moving the viewer up and down. One lid has 2x magnification and the other has 3.5x magnification. It measures 7cm diameter x 8cm high. Ages 5+ years

FD005K

Set of 10 \$66.95

FD005

Each \$6.95



### Magnifier Bug Box Viewer

Magnifier Viewer - Bug Box. Double magnifier container with measuring grid. Live bugs can be studied & measured as well as other items. Magnification 2x & 4x, suitable for primary and secondary school.

SER1127009

\$11.95



### Tuzzles - Magnifier Investigation Box

Students can investigate various objects up-close with this Magnifier Investigation Box. Examine and compare the textures, the colours and the shapes of both natural and man-made objects and discuss their findings. Students will learn to describe differences and similarities between the different objects. Conveniently have all different items stored together in one box and let the explorations begin! You will never have to search for a variety of objects again, this box will ensure that all different materials are always packed together. Mess-free and ready for use, this set will save you lots of time! The box measures 30 x 20cm. Ages 4+ years

BS834

\$57.95

Set of 6  
Save  
**\$775**

Extra large for  
easy viewing



### Giant Bug Viewer

This giant bug viewer allows kids to observe micro insects in a macro way! This ventilated bug viewer can be opened on both sides for easy access. Its large size (13.5cm high) makes it a versatile viewer for both small insects and larger specimens. The giant bug viewer has a 5x magnification.

FD150BK

Set of 6 ~~\$77.70~~ \$69.95

FD150B

Each \$12.95





**Pipette Filler Bulb - 3 Valve**

Very high quality bulb pipette filler, made in Germany these are perfect for any laboratory!

- The Top valve A is used to evacuate the bulb
- The Middle Valve S is used to control the fluid level in the pipette
- The Valve E is used to evacuate the bulb

SER1085006 \$12.95



**Pipette Filler Bulb**

The vinyl suction bulb goes on better with a special polyethylene fitting that neatly accommodates pipettes. The pipette is easily removed from the fitting.

SER1139996 \$3.95



**Thumb Wheel Pipette Pumps**

Accurate and easy to use with a large controllable thumb wheel.

SER1069001	2ml \$14.95
SER1069002	10ml \$14.95
SER1069003	25ml \$14.95

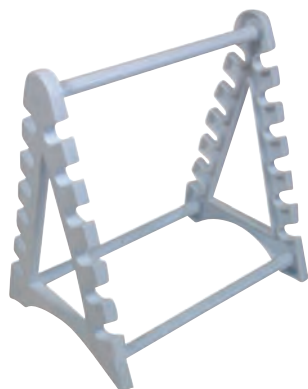

**Autoclavable Horizontal Pipette Storage**

These pipette stands are very stable, non-corrosive and virtually unbreakable.

SER1013001 Fits 12 \$16.60

**Circular Pipette Storage Stand**

This circular pipette stand holds 28 pipettes in a vertical position. Very stable, non-corrosive and virtually unbreakable.

SER1008002 Fits 28 \$22.95



**Wooden Pipette/Thermometer Storage**

This wooden pipette/thermometer storage holds 20 pipettes/thermometers in a vertical position.

SER1011070 20 Holes \$34.95



SER1212001

**Single PVC Coated Bottle Carrier - 2.5L**

The carriers provide impact protection.

SER1212001	Single - 2.5L \$29.95
SER1212003	Double - 2.5L \$39.95



SER1212003

## Racks & Carriers



SER1104031



SER1104026

### Bottle Storage

Perfect for Stuhl bottles, dropping bottles or flame test bottles.

SER1104031	10 Hole, 45mmD	\$19.95
SER1104026	12 Hole, 45mmD	\$19.95



### PVC Wire Bottle Storage – 20 x 50ml

This PVC wire rack has 20 places for 50ml bottles.

SER1151005	10 Hole, 45mmD	\$22.95
------------	----------------	---------



### Vertical or Flat Bunsen Burner Rack – 55 x 40mm

Great rack for keeping your Bunsen burners neat and out of harms way. Can be mounted to a wall or laying on a bench or shelf.

SER1011079	55 x 40mm	\$14.95
------------	-----------	---------



### Burette Drain/Storage Rack

This plastic burette drain and storage rack with a handy 10 places allow you to dry and store your clean burettes for use on the following day. The rack allows for wall or bench mounting.

SER1011062A	\$61.95
-------------	---------



### Poly Flask Stand

The stand will hold 5ml, up to 20L round bottom flasks.

SER1008001	\$15.95
------------	---------



### Wall Mounted Glove Dispenser

This dispenser is designed to be mounted on the wall. It holds 3 boxes of gloves.

SER1016013	Fits 3 Dispensers	\$69.95
------------	-------------------	---------

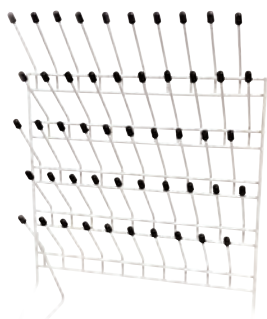

SER1151001

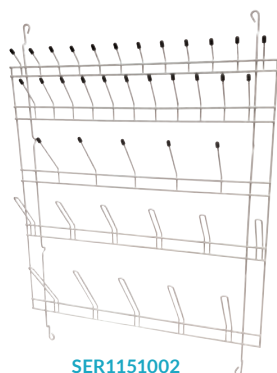

SER1151002

### Drying Rack

These racks can be used to dry labware in laboratory.

SER1151001	Bench Mount – 325 x 450mm	\$36.95
SER1151002	Wall Mount – 780 x 500mm	\$39.95



SER1010187



SER1010188

### Wooden Funnel Holder

Easy to use funnel holders, perfect solution if you need an extra pair of hands.

SER1010187	Single Funnel	\$16.95
SER1010188	Two Funnel	\$16.95

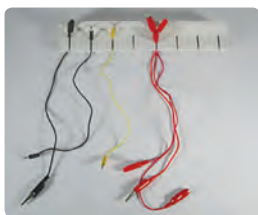

### Lead Storage Wall Mount – 40x6x7cm

Great little rack for keeping your wires untangled and ready for the next class! The storage unit can be mounted on the wall or bench.

SER1011078

\$11.95



### Petri Dish Rack

Very useful during inoculation, incubation and storage. Visibility from all sides enables the culture to be seen and checked during inoculation. Clear acrylic with white polycarbonate posts, with a capacity to hold 90 mm sizes petri dishes.

SER1172001

Fits 90mm, Acrylic \$54.95



### Slinky Spring Storage Rack

Great way to keep your slinky springs from getting tangled or lost.

SER1011081

30 Pairs \$49.95



### Safety Glasses Storage

Easily the best way to store your safety glasses. See how many you have at a glance and know that all the students have put them back.

SER1104038

30 Pairs \$49.95

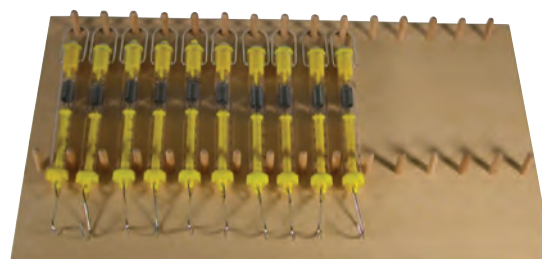

### Wall/Bench Spring Balance Rack

Keep your spring balances out of harms way with this great little rack! This can either be wall mounted or lay on a bench.

SER1011080

56 x 30mm \$14.95



### Poly Test Tube Basket

These baskets are ideal for draining and rinsing glassware. The baskets are autoclavable, non-corrosive and unbreakable.

SER1008117 140 x 120 x 110mm \$9.95

SER1008120 230 x 230 x 230mm \$19.95

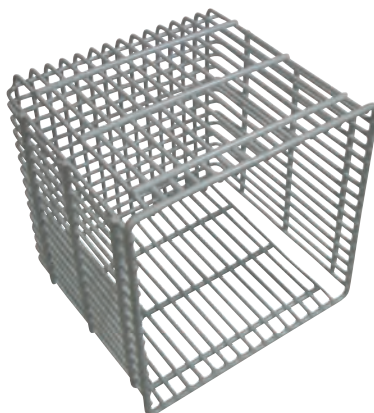

### PVC/Wire Test Tube Basket

SER1151004 150 x 150 x 150mm \$17.95



### Test Tube Stand

Polypropylene and autoclavable, with 3-tier design. It provides a clear view of the tube contents & convenient insertion and removal of the tubes.

EIS0708B

1.6cm dia x 31 Tubes \$9.95

## Racks & Carriers

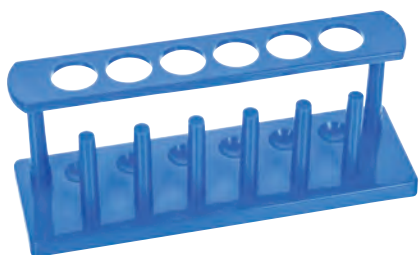

### Test Tube Stand Polypropylene

Polypropylene, autoclavable and has 6 place racks supported by 2 columns. It has six vertical pins for drying tubes. Colour may vary. Illustrated test tubes sold separately.

EIS0694B

\$6.60



### Test Tube Drying Rack

This drying rack can dry up to 28 test tubes at a time. It comes with a plastic tray to catch the water.

NK3001

\$39.95



### Test Tube Peg Holder

This jumbo-sized, wooden peg features an extension arm ideal for holding test-tubes over a flame. 19 x 1.2cm.

NK50818

\$2.75

### Test Tube Rack

These high quality test tube racks will withstand all the rigours of the laboratory environment and will last almost indefinitely. These are ideal to hold multiple test tube upright at the same time.

SER1035237	Poly Test Tube Rack – 18x25mm	\$12.95
SER1013006	Poly Test Tube Rack – 6 Hole, 6 Peg, 18 mm	\$5.30
SER1013004	Poly Test Tube Rack – 6 Hole, 6 Peg, 25mm	\$6.95
SER1008026	Poly Test Tube Rack – Fits 13 & 16mm, 60 Total	\$5.95
SERCH3989-601	Poly Test Tube Rack – Fits 8 x 25mm	\$19.95
SERCH3989-401	Poly Test Tube Rack – Fits 8x 10mm or 12x 16mm	\$19.95
SER1008210	Universal Poly Test Tube Rack – 4 Sided	\$18.50
SER1011068	Wooden Test Tube Rack – 6 holes, 6 Peg, 27mm	\$17.95
SER1011067	Wooden Test Tube Rack – 6 Hole, 27mm	\$16.95
SER1011069	Wooden Test Tube Rack – 12 Holes, 12 Peg	\$29.95
SER1052005	Aluminium Z-Shape Test Tube Rack	\$19.95

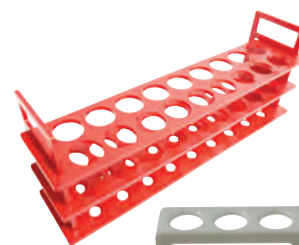

SER1035237



SER1013006



SER1008026

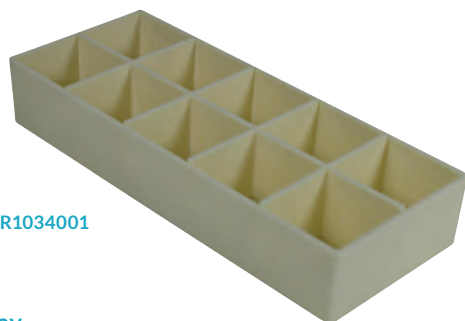

SER1034001



SER1034002

### Universal Tray

These are simple and strong universal dropping bottle holders. Each tray is able to hold 10 bottles sized 25ml to 50ml. They can also be used to store other items and can be used with or without divider.

SER1034001

With Divider \$4.95

SER1034002

Without Divider \$3.95

SER1034005

Divider Only \$1.95

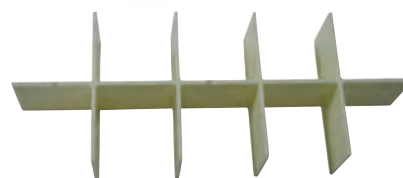

SER1034005

**Evaporating Basins**

These porcelain evaporating basins can be used to evaporate solutions and supernatant liquids.

SER1052206	Round Bottom Porcelain Evaporating Basin - 50ml	\$2.30
SER1052099	Round Bottom Porcelain Evaporating Basin - 60ml	\$2.40
SER1052201	Round Bottom Porcelain Evaporating Basin - 75ml	\$3.75
SER1052202	Round Bottom Porcelain Evaporating Basin - 100ml	\$3.95
SER1052199	Round Bottom Porcelain Evaporating Basin - 125ml	\$3.95
SER1052216	Round Bottom Porcelain Evaporating Basin - 400ml	\$8.95
NK0055K	Porcelain Evaporating Basins - 150mm - Set of 10	\$27.95
NK0055	Porcelain Evaporating Basins - 150mm - 10.4cm rim	\$2.95



**Filter Paper**

Semi-permeable filter paper available in multiple sizes is used in laboratories to separate fine particles from liquids.

SER1007015	Medium Qualitative Filter Paper - 70mm	\$5.70
SER1052207	Medium Qualitative Filter Paper - 90mm	\$5.95
SER1052208	Medium Qualitative Filter Paper - 110mm	\$8.95
SER1052509	Medium Qualitative Filter Paper - 125mm	\$11.95
SER1020042	Medium Qualitative Filter Paper - 150mm	\$12.95
SER1007012	Medium Qualitative Filter Paper - 180mm	\$16.95
SER1016007	Ashless Filter Paper No202 - 110mm	\$29.95
SER1016008	Ashless Filter Paper No41 - 70mm	\$44.95
EIS1392A	Filter Paper - 100 x 9cm Pieces	\$3.95
NK50811	Filter Paper 12.5cm	\$6.95



**Spatula**

These spatulas can be used to transfer powders and paste. The stainless steel spatulas are resistant to heat, acids, bases and solvents.

SER1010255	Stainless Chattaway Spatula - 150mm	\$3.50
SER1020033	Stainless Chattaway Spatula - 180mm	\$3.95
SER1020016	Stainless Bent/Flat Micro Spatula - 125mm	\$3.20
SER1010143	Stainless Nuffield Spatula - 140mm	\$3.95
SER1008116	Stainless Spoon/Spade Spatula - 180mm	\$3.95
SER1010254	Stainless Spoon/Spade Spatula - 150mm	\$3.50
SER1020011	Metal Double Ended Spatula - 175mm	\$3.95
SER1010472	Metal Pallet Knife Spatula - 150mm	\$4.95



## Stirrers & Tape Measures



### Porcelain Spotting Plate

These spotting plates can be used to observe reactions and colour changes in laboratory experiments. The ceramic plate is autoclavable, reusable and resistant to concentrated chemicals.

SER1052200 12 Hole \$4.95



### Poly Spotting Plate

These spotting plates can be used to observe reactions and colour changes in laboratory experiments. The ceramic plate is autoclavable, reusable and resistant to concentrated chemicals.

SER1099028 68 Hole - Pack of 10 \$19.95



### Teflon Coated Spin Bar Retriever

Magnet attached to stainless steel rod, with poly Teflon coating. Measurement: 315mm long.

SER1014799 12 Hole \$10.40

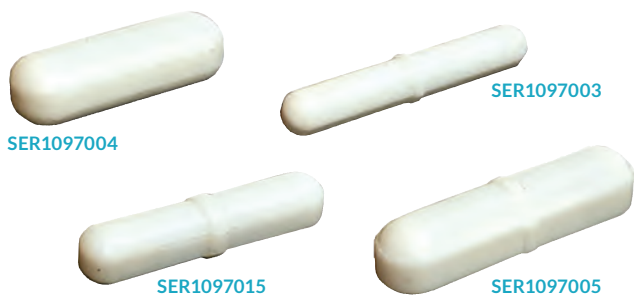

SER1097004

SER1097003

SER1097015

SER1097005

### Magnetic Stirrer Bar

These magnetic stirrers are used in laboratories to stir liquids.

SER1097004	20 x 8mm	\$4.95
SER1097015	33 x 7mm	\$5.30
SER1097005	40 x 10mm	\$5.95
SER1097003	60 x 9mm	\$8.95



SER1099012

SER1290001

SER1189001

### Stirring Rods

These glass, poly and wooden stirring rods can be used to mix liquids and chemicals for laboratory purposes.

SER1099012	Glass - 200 x 7mm	\$5.95
SER1290001	Poly - 300 x 6mm	\$4.95
SER1189001	Wooden - 114 x 10 x 2mm	\$18.95

### Tape Measure

Quality standard classroom tape measures. These measures will not tear, stretch or fray. The tape measures can be used to measure and compare the length of different objects and the flexibility of the measuring tape makes it possible to measure round objects as well as straight objects. Perfect to compare measurements of regular as well as irregular shapes

SER1052702	Soft Metric Tape Measure -150cm	\$4.70
SER1051001	Fiberglass Wind Up Tape Measure - 30m	\$25.95
SER1051003	Fibreglass Tape Measure - 100m	\$36.95
TFC13488	Tape Measure - 150cm - Pack of 12	\$23.95
DC13489	Tape Measure Class Kit - 150cm - Pack of 30	\$57.95
NK12742	Windup Open Tape Measure - 50m	\$30.95



SER1051001

DC13489

NK12742

## Rubber Stopper

These rubber stoppers provide tight seal to the opening of flasks, test tubes and general glassware.

SER1052150	Solid Rubber Stopper – 12T x 8B x 17H	\$4.95
SER1052152	Solid Rubber Stopper – 14T x 11B x 20H	\$5.95
SER1052154	Solid Rubber Stopper – 17T x 14B x 25H	\$5.10
SER1052156	Solid Rubber Stopper – 18T x 14B x 26H	\$9.95
SER1052158	Solid Rubber Stopper – 20T x 15B x 26H	\$8.95
SER1052160	Solid Rubber Stopper – 22T x 16B x 26H	\$7.95
SER1052162	Solid Rubber Stopper – 25T x 18B x 28H	\$8.95
SER1052164	Solid Rubber Stopper – 28T x 21B x 28H	\$10.95
SER1052166	Solid Rubber Stopper – 32T x 24B x 28H	\$11.95
SER1052170	Solid Rubber Stopper – 42T x 32B x 30H	\$16.95
SER1052172	Solid Rubber Stopper – 47T x 37B x 30H	\$20.95
SER1052174	Solid Rubber Stopper – 52T x 42B x 32H	\$39.95
SER1052151	1 Hole Rubber Stopper – x 3.0mm, 12T x 8B x 17H	\$3.95
SER1052153	1 Hole Rubber Stopper – x 4.5mm, 14T x 11B x 20H	\$4.95
SER1052155	1 Hole Rubber Stopper – x 5.5mm, 17T x 14B x 25H	\$4.95
SER1052157	1 Hole Rubber Stopper – x 6.5mm, 18T x 14B x 26H	\$8.95
SER1052159	1 Hole Rubber Stopper – x 6.5mm, 20T x 15B x 26H	\$9.95
SER1052161	1 Hole Rubber Stopper – x 6.5mm, 22T x 16B x 26H	\$8.95
SER1052163	1 Hole Rubber Stopper – x 6.5mm, 25T x 18B x 28H	\$9.95
SER1052165	1 Hole Rubber Stopper – x 6.5mm, 28T x 21B x 28H	\$11.95
SER1052167	1 Hole Rubber Stopper – x 6.5mm, 32T x 24B x 28H	\$13.95
SER1052169	1 Hole Rubber Stopper – x 6.5mm, 36T x 28B x 30H	\$18.95
SER1052171	1 Hole Rubber Stopper – x 6.5mm, 42T x 32B x 30H	\$21.95
SER1052173	1 Hole Rubber Stopper – x 5.5mm, 47T x 37B x 30H	\$22.95
SER1052177	1 Hole Rubber Stopper – x 6.5mm, 55T x 45B x 34H	\$49.95
SER1052168	Solid Rubber Stopper – 36T x 28B x 30H -Pack of 10	\$19.95
SER1012005	Rubber Stopper – 10x12.5x16	\$9.95



SER1012005

## Cork Stopper

Cork stoppers provide resistance to heat and compression. These are suitable for plugging vials, tubes & bottles.

SER1172092	Cork Stopper – 9B x 13T x 17Lmm	\$21.95
SER1172093	Cork Stopper – 12B x 17T x 22L	\$37.95
SER1172094	Cork Stopper – 18B x 24T x 29Lmm	\$89.95
SER1172095	Cork Stopper – 20B x 25T x 31Lmm	\$99.95
SER1172096	Cork Stopper – 27B x 33T x 31Lmm	\$130.95
SER1172097	Cork Stopper – 31B x 38T x 38Lmm	\$175.95
SER1099081	Cork Stopper – Assorted Sizes – Pack of 100	\$96.95



## Tubing

### Rubber Tubing

Great high quality tubing, soft that is resistant to acids and alkalis.

SER1172400	Orange Rubber Gas Tubing – 4 x 1mm	\$24.95
SER1172401	Orange Rubber Gas Tubing – 5 x 1.5mm	\$29.95
SER1172402	Orange Rubber Gas Tubing – 6 x 1.5mm	\$49.95
SER1172403	Orange Rubber Gas Tubing – 7 x 1.5mm	\$54.95
SER1172404	Orange Rubber Gas Tubing – 8 x 2mm	\$39.95
SER1172405	Orange Rubber Gas Tubing – 9 x 2.0mm	\$49.95
SER1172406	Orange Rubber Gas Tubing – 10 x 2mm	\$51.95
SER1172407	Orange Rubber Gas Tubing – 12 x 2.5mm	\$44.95
SER1172408	Orange Rubber Gas Tubing – 15 x 3.0mm	\$54.95
SER1172453	Red Rubber Pressure Tubing – 8 x 4.5mm	\$4.95
SER1172454	Red Rubber Pressure Tubing – 9 x 4.5mm	\$4.95

Gas, Orange



Pressure, Red



### Silicone Tubing

This great new silicone tubing is designed specifically for use with your Bunsen burners. It is specially ribbed to allow for durability and stability while in use, feeding your Bunsen burners with either LPG or natural gas.

SER1008082	Extra Soft Silicone Tubing – 8 x 2mm	\$5.50
------------	--------------------------------------	--------



### Tubing Connector

Glass tubing connectors are available in Y and T shapes

SER1052420	Glass Y Shape Tubing Connector – 7mm OD	\$0.95
SER1052419	Glass T Shape Tubing Connector – 7mm OD	\$0.95
SER1010546	Poly Y Shape Tubing Connector – 6mm OD	\$15.95
SER1010547	Poly T Shape Tubing Connector – 6mm OD	\$1.95
SER1008080	Poly Y Shape Tubing Connector – 7mm OD	\$0.95
SER1008079	Poly T Shape Tubing Connector – 7mm OD	\$0.95
SER1008115	Poly Straight Tubing Connector – 7mm, OD	\$2.25



SER1052420



SER1052419



SER1010546



SER1010547



SER1008115

### Poly/PTFE Tubing Valve

These valves are ideal to change direction, to block and release flow of liquids.

SER1008087	2-Way Poly/PTFE Tubing Valve – Fits 6-9mm Tubing	\$18.95
SER1008088	3-Way Poly/PTFE Tubing Valve – Fits 6-9mm Tubing	\$19.95



SER1008087



SER1008088





**Duracell Ultra Batteries**

Duracell Ultra Batteries are trusted quality with long lasting power. These Ultra batteries provide higher performance and are longer lasting for your everyday devices like motorised toys, flashlights, portable games consoles, remote controls. Great for keeping your stores for future use. Duralock Power Preserve technology keeps them charged for up to 10 years in storage. Trusted everywhere.

ACC8063	9Volt – Pack of 1	\$9.95
ACC8059	AAA – Pack of 4	\$12.95
ACC0432	AA – Pack of 4	\$11.95



**Duracell Rechargeable Batteries**

Duracell Recharge Ultra AAA batteries let you charge 400 times and with a Long-Life Ion Core you get amazing power in every battery. Plus, they come pre-charged so you can power your devices right away and will stay charged for up to 12 months, when not in use. Additionally, unused Duracell batteries are guaranteed to last 5 years. These powerful NiMH batteries work in any NiMH charger.

ACC9812	AA – Pk 4	\$34.95
ACC0080	AAA – Pk 4	\$34.95



**Duracell Button Cell**

Duracell with DuraLock power preserve technology which ensures up to a 10 year guarantee when stored. The packaging is child resistant as coin batteries can be hazardous if swallowed and should not be used by children.

ACC8082	2016 – Pack of 2	\$8.95
ACC8083	2025 – Pack of 2	\$8.95
ACC8084	2032 – Pack of 2	\$8.95



**Battery Charger**

Recharges AAA, AA, C, D and 9V batteries. LED indicator on each charging section. Recharges batteries in singles or in groups. Includes battery tester for 1.2V to 1.5V cells. Accepts various combinations of batteries. Operates from 240V mains socket.

EL3514	\$34.95
--------	---------



**Duracell All-In-One Battery Charger**

A simple, safe and reliable solution for your daily power needs. Suitable for electronic and medical devices. These batteries are long lasting and dependable.

ACC1625	\$39.95
---------	---------

*Warning: Button Batteries are attractive to young children as they are bright, shiny and easy to swallow. If a battery is swallowed, they can present a serious hazard and medical attention should be immediately sought. Please keep these button batteries away from and inaccessible to children and students.*



**Eclipse Lithium Button Battery 3V**

Eclipse Lithium Button Battery 3V ideal for use in small electronics such as hand held or portable devices. A super long lasting battery as it has low self discharge and will hold its charge for a long period when not in use.

EL2522	\$1.95
--------	--------

**Duracell Coppertop Batteries**

Duracell Coppertop Batteries are trusted quality with long lasting power. These Coppertop AA batteries provide reliable power for your everyday devices like motorised toys, flashlights, portable games consoles, remote controls. Great for keeping your stores for future use. Duralock Power Preserve technology keeps them charged for up to 10 years in storage. Trusted everywhere.

ACC9413	AA – Pack of 4	\$10.95
ACC9410	AA Pk24	\$25.95
ACC9409	AAA – Pack of 24	\$23.95
ACC9406	AAA – Pack of 4	\$10.95
ACC9595	Size C – Pack of 2	\$8.95
ACC2404	Size D – Pack of 4	\$17.95
ACC9588	9V – Pack of 1	\$8.95



ACC9413



ACC9406



ACC9595



ACC9588

Lab Essentials



**Primary Science Jumbo Eyedroppers**

3+ yrs

These Jumbo Eyedroppers teach young scientists fine motor skills. The stand provides convenience and storage. A great resource to get the young students interested in science!

LER2779 Set of 6 \$32.95



**Super-Safe Eye Droppers**

A durable shatterproof dropper made of clear plastic with a rubber bulb. Pack of 12 each measuring 8.5cm long. Ages 5+ years

LS446 Pack of 12 \$19.95



**Easy Grip Tweezers**

5+ yrs

These extra large (15cm) tweezers have a comfortable grip and are excellent for small hands. Supplied in assorted colours. A guide with suggested activities is included.

LER1963 Pack of 12 \$26.95



Set of 10  
**\$25<sup>95</sup>**  
Save \$3.55

**Tweezers**

Tweezers with bent head. Tweezers are 12.5cm long.

EIS5030 Each \$2.95  
EIS5030-10 Set of 10 ~~\$29.50~~ \$25.95



Pack of 10

**Plastic Tweezers**

Plastic Tweezers used for picking up objects too small for human hands.. Easy to grasp and close. Use in the biology, science classroom or for general exploration. Made of flexible, hard-wearing plastic.

NK50805 Pack of 10 \$7.95



**Cork Borers – 6 Sizes**

These cork borers come in six different sizes which includes 3.8 , 5.3, 7.0 , 8.5, 10.0 and 11.5mm.

SER1010157 \$34.95



**Cork Borers Sharpener**

This is used to sharpen your cork borer to ensure a clean and precise cut with each use.

SER1010158 \$23.95

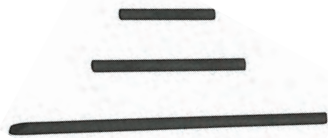

**Carbon Rod – 150 x 6mm**

Can be used for experiments with homemade batteries.

SER1010418 \$14.95

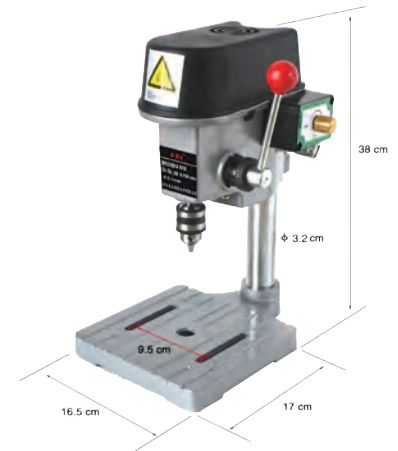

**Bench Drill/Cork Borer**

This prevents jagged holes in wood (Speed too slow) and protects against overheated plastic (Speed too fast). Drilling PCBs, steel, brass or any metal is a breeze. Great for Hobby Craft Work. Specs: 3 speed. 8000, 11000 & 16000rpm. Max speed travel 25mm Weight 5.3kg. This is a must for every Technology Room.

SER1052969 \$169.95



**Griffin Type Glass Cutter**

Great for any type of tube cutting, perfect for when making up pastures apparatus or similar.

SER1014152 \$20.30



**Charcoal Carbon Blocks**

These carbon blocks can be used for experiments with homemade batteries.

SER1010165 100 x 25mm \$15.95



**Chromatography Paper – 20x20cm**

Use the chromatography paper to separate chemicals and substances.

SER1099500 Pack of 100 \$69.95



**Super Spring – 60mm Diameter**

The clear tubes are freestanding, which means that students can go “hands-free” while investigating all things bright, noisy, aromatic or just plain cool.

CUS0304 Pack of 100 \$11.95



**Measuring Containers**

Set of 18 measuring containers with wide mouths for easy measuring. The set contains 10 x 100ml, 5 x 200ml, 2 x 500ml and 1 x 1 litre containers.

DM1033 18 pieces \$46.95



**Calorimeter Joules Heater-Stirrer-Insulation**

This calorimeter can be used as is to measure the specific heat of different liquids. It can also be used with the included heating element to determine the electrical equivalent.

SER1010089 \$29.95

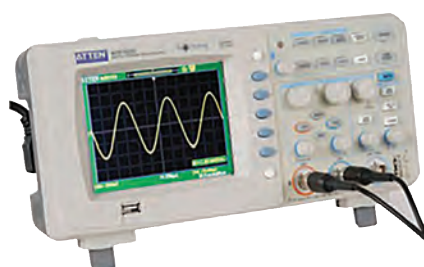

**Oscilloscope – Dual Trace Digital – 20Mhz**

Use the oscilloscope to display, process and analyse the waveform and bandwidth of electronic signals.

SER1149001 \$749.95



**Turbidity Tube – 60.5cm**

Measure turbidity in streams where a secchi disk cannot be used.

SER1103018 \$29.95



**Sunpaper Kit – UV Reacting Paper**

Sunpaper UV reacting paper goes through a chemical reaction when exposed to light, leaving a permanent image on the paper.

TH891 \$39.95

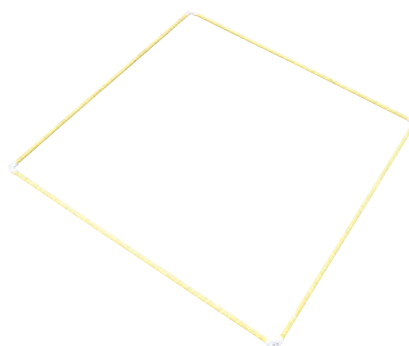

**Collapsible Quadrat Grid – 1m<sup>2</sup>**

The quadrat is a highly portable sampling tool.

SER1011147 \$39.95

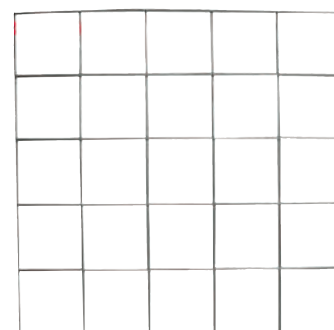

**Quadrat Grid – 50x50cm with 10cm Squares**

This quadrat is for taking population survey on flat terrain.

SER1011118 \$25.95

## Lab Essentials

### Buchner Funnel

These buchner funnels are used for filtration with the assistance of atmospheric pressure.

SER1052468A	Porcelain Buchner Funnel – 50mm	Each	\$9.95	10 or more – \$8.95
SER1052468	Porcelain Buchner Funnel – 65mm	Each	\$10.95	10 or more – \$9.95
SER1010241	Porcelain Buchner Funnel – 80mm	Each	\$14.95	10 or more – \$13.95
SER1010242	Porcelain Buchner Funnel – 100mm	Each	\$19.95	10 or more – \$17.95

SER1052468A



SER1010241

SER1012002

### Mortar & Pestle

Use this tool to grind and crush substances.

SER1052212	Ceramic Mortar & Pestle – 60mm	Ceramic Mortar & Pestle 60mm OD, 50mm ID, 30mm High, Wall 5mm Thick. Pestle 58mm long. Thickness 9mm tapering out to 18mm. Ground section 30mm long each.	\$3.20
SER1052466	Ceramic Mortar & Pestle – 80mm	Ceramic Mortar & Pestle 80mm OD, 65mm ID, 40mm High, Wall 7mm Thick. Pestle 90mm long. Thickness 10mm tapering out to 23mm. Ground section 35mm long.	\$6.95
SER1052204	Ceramic Mortar & Pestle – 105mm	Ceramic Mortar & Pestle 105mm OD, 85mm ID, 50mm high, Wall 9mm Thick. Pestle 100mm long. Thickness 13mm tapering out to 25mm. Ground section 40mm long.	\$5.95
SER1052213	Ceramic Mortar & Pestle – 225mm	Ceramic Mortar & Pestle 225mm OD, 195mm ID, 95mm High, Wall 15mm Thick. Pestle 205mm long. Thickness 20mm tapering out to 40 mm. Ground section 60mm long. Each.	\$19.95



### Bristle Brush

Our various test tube brushes feature good quality bristles mounted on heavy gauge, twisted galvanized wire. They have a double radial tufted end which makes it extremely easy to clean the entire burette or test tube, including the hard to reach bottom of the tube.

SER1010247	Bristle Brush – 17 x 50mm – 15cm	\$1.50
SER1010248	Bristle Brush – 25 x 75mm – 20cm	\$1.50
SER1020019	Bristle Brush – 35 x 75mm – 24cm	\$1.95
SER1010249	Bristle Brush – 40 x 75mm – 30cm	\$1.95
SER1016065	Bristle Brush – 17 x 125mm – 23cm	\$1.50
SER1010250	Bristle Brush – 12 x 250mm – 75cm	\$1.95



### Test Tube Brush

This test tube brush is ideal to keep test tubes clean. The test tube brush is 230 mm long, with a brush length of 80 mm. The brush has a diameter of 12 mm. The test tube brush has a fan-shape end and made of nylon. The brush comes on a stainless steel wire handle.

EIS0204C-30	Test Tube Brush – White Head – Set of 30	\$57.95
EIS0204C	Test Tube Brush – White Head	\$2.65
EIS0204C-10	Test Tube Brush – White Head – Set of 10	\$20.95



### Crucibles

General use porcelain crucible, including lid. Every size is glazed and suitable for use with high temperatures.

SER1052210	Medium Porcelain Crucible with Lid - 15ml	\$1.50
SER1052205	Medium Porcelain Crucible with Lid - 18 ml	\$1.50
SER1052203	Medium Porcelain Crucible with Lid - 30ml	\$1.95
SER1052600	Medium Porcelain Crucible with Lid - 40 ml	\$2.10
SER1016140	Medium Porcelain Crucible with Lid - 50 ml	\$2.25
SER1052211	Medium Porcelain Crucible with Lid - 70 ml	\$2.95
SER1052467	Medium Porcelain Crucible with Lid - 100ml	\$4.95
SER1052742	Low Porcelain Crucible with Lid - 30ml	\$19.95
SER1016243	Low Porcelain Crucible with Lid - 50ml	\$18.95
SER1218006	Porcelain Gooch (Filtration) Crucible with Lid - 30ml	\$4.50
SER1008077	99% Pure Nickel Crucible with Lid - 15 ml	\$22.95
SER1008078	99% Pure Nickel Crucible with Lid - 25 ml	\$25.95
SER1105027	99% Pure Nickel Crucible with Lid - 50 ml	\$32.95



Porcelain Medium



Porcelain Low



Porcelain, Gooch (Filtration)



Nickel

### Tongs

These tongs allow students to grip or hold small test tubes or handle hot apparatus so they will not burn their hands or spill harmful chemicals.

EIS0735F	Stainless Steel Crucible Tongs with Bow - 20cm	\$7.50
SER1010169	Stainless Crucible Tongs - 250mm	\$9.95
SER1014432	Plastic Coated Beaker Tongs	\$8.95



EIS0735F

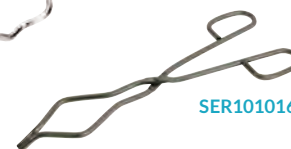

SER1010169



SER1014432

### Bench Mat

Great new silicone protective bench mats. Smooth surface, no ridges, chemical and heat resistant and non-slip to prevent your experiments ending up on the floor!

SER1008091	Bench Mat - Silicone Protective Mat - 150 x 150mm	\$6.95
SER1008092	Bench Mat - Silicone Protective Mat - 250 x 250mm	\$10.95
SER1008090	Bench Mat - Silicone Protective Mat - 400 x 300mm	\$21.95
SER1099024	Bench Mat - 300x300x5mm	\$8.95

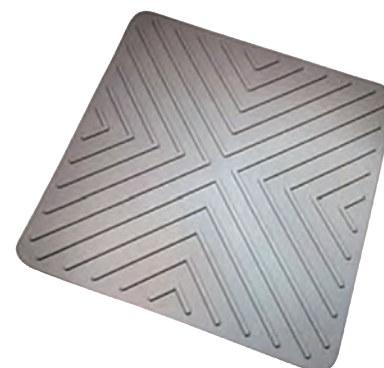

Lab Essentials



**5-230 Mesh Sieves – 20 x 5cm**

Sieves set of six, consists of six stainless steel sieves with lid and base. Mesh size: 5, 10, 35, 60, 120, 230 diameter 190mm. Mesh number is a number of holes per square inch.

SER1052739 Set of 6 \$159.95



**Tesla Coil**

Special transformer with primary and secondary coils tuned to resonate.

SER1055022 \$366.95



**Bean Bag**

15 x 15cm bean bags.

SER1052033 120g \$4.95



**Porcelain Combustion Boat**

Sizes are approximate and can vary due to shrinkage in manufacturing process.

Size: 11 x 6 x 9mm

SER1016062 72mm \$15.95



**Rubber Ribbed Teat**

SER1125001 Pack of 10 \$4.95

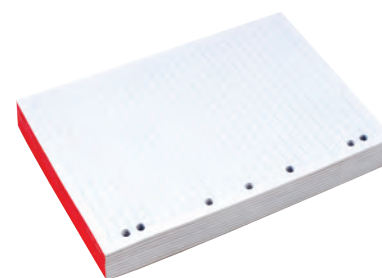

**Graph Pad 10mm A4**

Set of 10 Graph Pads, each containing 50 pages. Only one pad shown.

NP8016 Set of 10 \$27.95



**Magnetic Teacher Ruler**

Chalkboard / whiteboard, magnetic, 1m. Two strips of magnetic material allows the ruler to be held firmly to the board if metal based. One metre in metres and centimetres.

SER1064040 1m \$19.95



**Ruler**

SER1010011 Plain Ends – 1m \$7.95  
SER1010012 Brass Ends – 1m \$7.95



**Wooden Chalkboard Ruler**

Wooden Quality, Plain Ends  
SER1121054 1m \$14.95



**Safety Screen with Wings**

Perspex. 50 wide x 61cm high x 4mm thick. Perspex with hinged wings which measure 23cm long each side.

SER1104048

50x61cmx4mm \$199.95



**Autoclave Bag**

These bags are tear and heat resistant. Each bag is labeled with biohazard warning markings and also basic use instructions.

SER1052750

40 x 60cm \$36.95



**Autoclave Indicator Tape**

Autoclave tape works by changing colour after exposure to temperatures, to indicate whether a specific temperature has been reached.

SER1052751

50m Roll \$8.95



Save  
**\$2135**

**Glue Gun Value Kit**

This glue gun value kit includes 10 low melt glue guns and 40 hot glue sticks. Great for building strong structures for STEAM activities.

TH120K

50x61cmx4mm \$121.30 \$99.95

**Glue Gun**

Great for quick and easy low stress repairs to timber, cardboard, paper and many household materials. It is fast, easy and simple to use with the trigger controlled glue feed. Mains powered 100W. Requires 11mm diameter glue sticks (2 supplied).

SER1024087

\$33.95



**Glue Gun – Spare Glue Sticks**

These glue sticks are 11mm in size, and are suitable for use with SER1024087.

SER1024088

11mm \$5.95

## Primary Lab Essential Kits

~~\$1,778.75~~  
**\$1,499<sup>95</sup>**  
 Save \$278.80



### Lab Essentials Class Kit

This Lab Essentials classroom kit is an ideal laboratory equipment essentials set. This comprehensive set of science lab resources includes a great range of high quality scientific resources to help start and equip your lab or replenish your existing Science materials inventory.

SCI002 Kit \$1,499.95

### Primary Science Deluxe Lab Set

3+ yrs

Perfectly sized science tools to support early hands-on science investigations. The set includes 20 activity cards, test tubes, funnels, primary science viewscope with observation dish, journal and more tools.

LER0826 \$99.95



### Primary Science Set

3+ yrs

This great primary science set includes real science tools and supports hands-on early science investigations. The set includes beaker, magnifying glass, funnel, eyedropper, flask, tweezers, goggles, test tubes and activity guide.

LER2784 \$54.95



Download  
10 additional  
activity  
sheets online







### Scout Touch Balance – 220g x 0.001g

Setting new standards in laboratory and industrial weighing: the next generation of Scout balances. The OHAUS Scout features an easy-to-navigate colour touchscreen display and a slim design which allows stackable storage. Geared for superior performance with fast stabilisation time and high resolution weighing results, making this the perfect balance for your classroom or laboratory. Capacity: 0.001 – 220.000g, pan size: 93mm.

SERSTX223

220 x 0.001g \$899.95



### Scout Education Balance – 120g x 0.001g

Designed for education applications, with a large backlit LCD backed by education software. It is built to endure demanding classroom conditions with superior overload protection. Featuring faster stabilisation time, increased capacity and a stackable design that makes this balance perfect for your classroom or laboratory. Capacity: 120g, pan size: 93mm.

SERSKX123

120 x 0.001g \$598.95



### Scout Education Balance – 420g x 0.1g

The SCOUT SKX 421 is built to endure demanding classroom applications with superior overload protection. Features including faster stabilisation time, increased capacity, multiple connectivity options and stackable design make Scout the best weighing experience for The next generation classroom. Capacity: 420 x 0.1g, pan size: 120mm.

SERSKX421

420 x 0.1g \$379.95



### Scout Education Balance – 420g x 0.01g

The next generation of portable balances for your classroom. Integrated superior overload protection system rated at 10x capacity protects the balance in demanding classroom environments. Featuring faster stabilisation time, increased capacity, multiple connectivity options and a stackable design. Capacity: 420 x 0.01g, pan size: 120mm.

SERSKX422

420 x 0.01g \$599.95



### Scout Education Balance – 620g x 0.01g

Designed for education applications, the OHAUS Scout with large backlit LCD backed by education software is the ideal balance for your classroom. It is built to endure demanding classroom applications with superior overload protection. Features including faster stabilisation time, increased capacity, multiple connectivity options and stackable design make Scout the best weighing experience. Capacity: 620 x 0.01g, pan size: 120mm.

SERSKX622

620 x 0.01g \$629.95



### Scout Education Balance – 620g x 0.1g

The SCOUT SKX 621 is built to endure demanding classroom applications with superior overload protection. Features including faster stabilisation time, increased capacity, multiple connectivity options and stackable design make Scout the best weighing experience for the next generation classroom. Capacity: 620 x 0.1g, pan size: 170 x 140mm.

SERSKX621

620 x 0.1g \$459.95



### Scout Education Balance – 220g x 0.01g

The next generation of portable balances for your classroom. Designed for education applications, the OHAUS Scout with large backlit LCD backed by education software is the ideal balance for your classroom. It is built to endure demanding classroom applications with superior overload protection. Capacity: 220g x 0.01, pan size: 120mm.

SERSKX222

220 x 0.01g \$459.95

## Balances



### Scout Education Balance – 1200g x 0.01g

The next generation of portable balances for your classroom. Integrated superior overload protection system rated at 10x capacity protects the balance in demanding classroom environments. Featuring faster stabilisation time, increased capacity, multiple connectivity options and a stackable design. Capacity: 420 x 0.01g, pan size: 120mm. Capacity: 1200 x 0.01g, pan size: 170 x 140mm.

SERSKX1202

1200 x 0.01g \$669.95



### Scout Education Balance – 2200g x 0.01g

Designed for education applications, the OHAUS Scout with large backlit LCD backed by education software is the ideal balance for your classroom. It is built to endure demanding classroom applications with superior overload protection. Features including faster stabilisation time, increased capacity, multiple connectivity options and stackable design make Scout the best weighing experience for the next generation classroom. 2200 x 0.01g, pan size: 170 x 140mm.

SERSKX2202

1200 x 0.01g \$699.95



### Scout Education Balance – 2200g x 0.1g

This balance is built to endure demanding classroom applications with superior overload protection. Features including faster stabilisation time, increased capacity, multiple connectivity options and stackable design make Scout the best weighing experience for the next generation classroom. Capacity: 2200 x 0.1g, pan size: 170 x 140mm.

SERSKX2201

2200 x 0.1g \$499.95



### Scout Education Balance – 6200g x 0.1g

Designed for education applications, the OHAUS Scout with large backlit LCD backed by education software is the ideal balance for your classroom. It is built to endure demanding classroom applications with superior overload protection. Features including faster stabilisation time, increased capacity, multiple connectivity options and stackable design make Scout the best weighing experience for the next generation classroom. Capacity: 6200 x 0.1g, pan size: 170 x 140mm.

SERSKX6201

6200 x 0.1g \$579.95



### Scout Education Balance – 8200g x 1g

The SCOUT SKX 8200 is built to endure demanding classroom applications with superior overload protection. Features including faster stabilisation time, increased capacity, multiple connectivity options and stackable design make Scout the best weighing experience for the next generation classroom. Capacity: 8200 x 0.1g, pan size: 170 x 140mm.

SERSKX8200

8200 x 1g \$449.95



### Scout Touch Balance – 220g x 0.01g

Setting new standards in laboratory and industrial weighing – the next generation of Scout Balances. Ideal for laboratory and industrial applications, the OHAUS Scout features an easy-to-navigate colour touchscreen display and a slim design which allows stackable storage. Geared for superior performance with fast stabilisation time and high resolution weighing results, these portable balances set a new standard for a broad range of weighing applications. 220g x 0.01g, pan size: 120mm.

SERSTX222

220 x 0.01g \$599.95



### Scout Touch Balance – 420g x 0.01g

Featuring superior overload protection and expanded connectivity options. The large, resilient colour touchscreen allows for effortless operation of the Scout through its informative icon driven menu structure, guiding the user through every step of the weighing application. Stabilisation time as fast as 1 sec means increased productivity in your classroom or laboratory. Capacity: 420g x 0.01g, pan size: 120mm.

SERSTX422

420 x 0.01g \$719.95



### Scout Touch Balance – 420g x 0.1g

Ideal for laboratory and industrial applications, the OHAUS Scout features an easy-to-navigate colour touchscreen display and a slim design which allows stackable storage. Geared for superior performance with fast stabilisation time and high resolution weighing results, these portable balances set a new standard for a broad range of weighing applications. Capacity: 420g x 0.1g, pan size: 120mm.

SERSTX421

420 x 0.1g \$539.95



### Scout Touch Balance – 620g x 0.01g

Equipped with advanced weighing technology, the Scout also ensures repeatable and reliable weighing results. Integrated superior overload protection system rated at 10 times the capacity protects the balance in rugged and demanding environments. The space-saving, slim design allows for stackable storage. Capacity: 620g x 0.01g, pan size: 120mm.

SERSTX622

620 x 0.01g \$779.95



### Scout Touch Balance – 620g x 0.1g

Geared for superior performance with fast stabilisation time and high resolution weighing results, these portable balances set a new standard for a broad range of weighing applications. Features also include superior overload protection and expanded connectivity options. Capacity: 620g x 0.1g, pan size: 170 x 140mm.

SERSTX621

620 x 0.1g \$549.95



### Scout Touch Balance – 2200g x 0.01g

Setting new standards in laboratory and industrial weighing – the next generation of Scout Balances. Ideal for laboratory and industrial applications, the OHAUS Scout features an easy-to-navigate colour touchscreen display and a slim design which allows stackable storage. Geared for superior performance with fast stabilisation time and high resolution weighing results, these portable balances set a new standard for a broad range of weighing applications. Capacity: 2200g x 0.01g, pan size: 170 x 140mm.

SERSTX2202

2200 x 0.01g \$899.95



### Scout Touch Balance – 2200g x 0.1g

Featuring superior overload protection and expanded connectivity options. The large, resilient colour touchscreen allows for effortless operation of the Scout through its informative icon driven menu structure, guiding the user through every step of the weighing application. Stabilisation time as fast as 1 sec means increased productivity in your classroom or laboratory. Capacity: 2200g x 0.1g, pan size: 170 x 140mm.

SERSTX2201

22200 x 0.1g \$629.95



### Scout Touch Balance – 8200g x 1g

Equipped with advanced weighing technology, the Scout also ensures repeatable and reliable weighing results. Integrated superior overload protection system rated at 10 times the capacity protects the balance in rugged and demanding environments. The space-saving, slim design allows for stackable storage. Capacity: 8200g x 1g, pan size: 170 x 140mm.

SERSTX8200

8200 x 1g \$549.95

## Balances



### Precision Balance with Draft Shield – 420g x 0.001g

Fast stabilisation and reliable operation are enhanced by the AutoCal option to ensure solid weighing performance and accurate, repeatable results for standard laboratory applications. Capacity: 420g x 0.001g, pan size: 130mm.

SERAX423 420 x 0.001g \$1,899.95



### Pioneer Precision IC Balance – 420g x 0.001

The Pioneer PX combines essential weighing functionality with competitive performance, offering high accuracy and repeatability for applications in laboratory, industrial and education settings. Capacity: 420 g x 0.001 g, Pan Size: 120 mm.

SERPX423 420g x 0.001 \$1,299.95



### Precision Balance with Draft Shield

The OHAUS Pioneer Series of analytical and precision balances are designed for basic routine weighing in a variety of laboratory, industrial and education applications. With the right combination of performance and features, the OHAUS Pioneer offers uncomplicated performance for all your basic weighing needs. Capacity: 220g x 0.001g.

SERAX223E 220 x 0.001g \$1,499.95



### Precision Balance with Draft Shield & Autocal

Fast stabilisation and reliable operation are enhanced by the AutoCal option to ensure solid weighing performance and accurate, repeatable results for standard laboratory applications. Capacity: 220g x 0.001g, pan size: 130mm.

SERAX223 220g x 0.001g \$1,759.95



### Precision Balance with Draft Shield – 520g x 0.001g

Featuring fast stabilisation and reliable operation are enhanced by the AutoCal option to ensure solid weighing performance and accurate, repeatable results for standard laboratory applications. Capacity: 520g x 0.001g pan size: 130mm.

SERAX523 520 x 0.001g \$2,149.95



### Analytical, Draft shield – 120g x 0.0001g

This balance features fast stabilisation and reliable operation are enhanced by the AutoCal™ option to ensure solid weighing performance and accurate, repeatable results for standard laboratory applications. Capacity: 120g x 0.0001g, pan size: 90mm.

SERAX124E 120 x 0.0001g \$1,899.95



### Analytical Balance with Draft Shield – 120g x 0.0001g

This balance features a full colour touch screen, the ability to complete weighing, parts counting, percent weighing, checkweighing, animal/dynamic weighing, totalisation/statistics, formulation and density determination. Making it the perfect balance for your classroom or lab. Capacity: 120g x 0.0001g, pan size: 90mm.

SERAX124 8200 x 1g \$2,299.95

### Analytical Balance with Draft Shield – 220g x 0.0001g

Fast stabilisation and reliable operation are enhanced by the AutoCal option to ensure solid weighing performance and accurate, repeatable results for standard laboratory applications. This balance has the ability to complete weighing, parts counting, percent weighing, checkweighing, animal/dynamic weighing, totalisation/statistics, formulation and density determination, making it an essential item in any laboratory. Capacity: 220g x 0.0001g, pan size: 90mm.

SERAX224 220 x 0.0001g \$2,499.95



### Analytical Balance with Draft Shield – 320g x 0.0001g

Fast stabilisation and reliable operation are enhanced by the AutoCal option to ensure solid weighing performance and accurate, repeatable results for standard laboratory applications. The two piece, top-mounted draft shield doors reduce the footprint of the doors in the rear of the balance when open, and open wide on both sides in order to provide ample room to place samples. Capacity: 320g x 0.0001g, pan size: 90mm.

SERAX324 320 x 0.0001g \$2,799.95



### Digital Balance

This digital balance has a capacity of 2000 x 0.01gm. High precision, sensor strain, round transparent draughtshield, high contrast large backlit LCD, built-in corner spirit level, calibration weights supplied, 2 year warranty, battery and mains.

SER1052982 2000 x 0.01g \$299.95



### Traveller – 150g x 0.01g

Unique Portable Balance with Integrated Draftshield. The unique draftshield on the Traveller is what sets this portable balance apart. The weigh-thru design protects the load cell from disruption from the elements to ensure weighing accuracy. Capacity: 150g x 0.01g, pan size: 120mm.

SERTA152 150 x 0.01g \$369.95



### Traveller – 3000g x 0.1g

The unique draftshield on the Traveller is what sets this portable balance apart. The weigh-thru design protects the load cell from disruption from the elements to ensure weighing accuracy. The balances can be neatly stacked and locked into place on top of each other, providing a simple way to safely store the balances. Capacity: 3000g x 0.1g, pan size 120x135mm.

SERTA3001 3000 x 0.1g \$449.95



### Explorer Semi-Micro – 51g/120g

The Explorer Semi-Micro Balance is built for sophisticated, professional weighing. Ingenious construction designed to enhance usability, intuitive software provides an extremely modern user experience, intelligent performance for applications requiring extreme accuracy. Capacity: 51 g; 120 g. Readability: 0.01 mg; 0.1 mg.

SEREX125D 0.01mg; 0.1mg \$5,499.95



### Explorer Semi-Micro – 120g

The different applications of this balance include weighing, percent weighing, parts counting, check weighing, dynamic/animal weighing, filling, totalisation, formulation, differential weighing, density determination, peak hold, pipette adjustment. It is built for sophisticated, professional weighing. Capacity: 120 g. Readability: 0.01 mg.

SEREX125 0.01mg; \$6,499.95



### Explorer Semi-Micro – 120g/220g

The Explorer Semi-Micro Balance is built for sophisticated, professional weighing. Applications include, weighing, percent weighing, parts counting, check weighing, dynamic/animal weighing, filling, totalisation, formulation, differential weighing, density determination, peak hold, pipette adjustment. Capacity: 120g; 220g. Readability: 0.01mg; 0.1mg.

SEREX225D 0.01mg; 0.1mg \$6,699.95

## Balances



### Digital Balance - 5000 x 1g

A simple balance with a capacity of 5000g reading at 1g intervals with an LCD display. The pan size is 150mm in diameter.

SER1052280

5000 x 1g \$81.95



### Digital Ds Cw Balance- 200x0.001G

A simple digital pan balance with a maximum capacity of 200g reading at intervals of 0.001g.

SER1052946

200x0.001g \$312.95



### Triple Beam Balance

Triple Beam Balance is well-equipped to handle any weighing job, whether you're weighing solids, liquids, powders or even animals. The top loading Triple Beam Balance Series is known world wide as for its durability and versatility to accommodate a range of lab applications. Capacity: 2610 x 0.1g.

SER1052281

2610 x 0.1g \$162.95



### Compact Bench Balance

The multipurpose Ranger 3000 has all of the capabilities to produce precise results rapidly for a variety of applications. With seven application modes, the Ranger 3000 is the ideal scale to meet many industrial weighing needs. Capacity: 30kg x 1g

SER1004801

30kg x 1g \$499.95



### Kitchen Scale/Tray 10kg

This jumbo scale is ideal for weighing those heavier items. Graduations are marked in increments of 50g. Easy to read dial and robust construction.

DC17013

Each \$25.95



### Digital Kitchen Scale with Bowl 1g to 5kg

This digital kitchen scale is accurate, with 1g increments. The scale measures up to 5kg and comes with detachable bowl.

DN4008W

1g increments \$41.95



### Kitchen Scale Max 500g - 5g increments

This kitchen scale is ideal for measuring smaller volumes and/or mass when more accuracy is required. The scale measures up to 500g, in 5g increments.

DN4004  
6 or more

Each \$15.95  
Each \$13.50

Balances



**Junior Balance**

A tough balance designed for rough handling yet accurately weighs solids and liquids. A compact balance which children can use to develop their awareness of mass and volume differences. Anything from water, sand, plasticine, Playplas®, plastic, foam, chalk or even SimFit™ cubes can be compared using the Junior Balance. Hoppers hold 1/2 litre to filling mark and have lids. Can be easily taken apart for cleaning.

TFC30087

\$29.95



Set of 4  
Save  
**\$985**



6+  
yrs

**Measuring Balance**

An excellent primary or upper elementary school balance for accurately determining the mass of solids and liquids. This durable and accurate plastic balance has an easy zero adjustment, clear graduated 1 litre buckets with lids, 14 stackable weights (2 x 20g, 4 x 10g and 8 x 5g), 11 metal weights (1 x 50g, 2 x 20g, 2 x 10g, 2 x 5g, 2 x 2g and 2 x 1g). The balance measures 47 x 14.5cm high.

GG1054

Each \$64.95

TFC10222

Set of 4 \$249.95



**Rocker Scale 1L**

Transparent tubs marked with 100ml graduations to a maximum capacity of 1 litre, made in tough, washable material. Sensitive enough to 1g to register a positive movement and the tubs are designed to give accurate readings even when objects are placed off centre. Contents of tubs not included.

NK16464

\$79.95



Set of 6  
Save  
**\$275**

**Simple Scales with Weights**

These sturdy scales come with an additional set of weights (16x 10g and 8x 5g) to compare mass. The tubs are detachable and can hold up to 200ml of liquid. A great value balance kit when space is limited! The balance measures 33 (L) x 8 (W) x 7(H) cm.

NK1100K

Set of 6 \$74.95

NK1100

Each \$12.95

10 or more

Each \$9.95



TFC15195



TFC15199

**Kitchen Scale**

These unique scales have transparent cases that allow you to see the working mechanisms. Very robust, all metric dial (2kg version is marked in 10g and 5kg version in 25g increments) with solid steel base these are exceptional value.

TFC15195

2kg \$16.95

TFC15199

5kg - Blue \$16.95



6+  
yrs

**Wooden Scales**

An extremely strong set of beech wood scales with plastic pans. The scales measure 40 x 15cm and each pan is 17.5cm in diameter. Illustrated play food not included.

ED2185

\$119.95

## Balances & Heaters



### Pan Balance

This balance features translucent, large capacity pans marked at 200ml increments which hold up to 1 litre of liquid or solids. Compensator clips for level and accurate measurements. Includes 5 x 1g, 5 x 5g and 5 x 10g stackable weights which can be easily stored in the bottom of the base. Made of durable, washable plastic. Assembled dimensions 75 x 33cm. Foundation to Grade 6.

TFC10489 \$32.95  
2 or more Each \$28.95



### Bucket Balance

This balance features large capacity 2L buckets. Compensator clips for level and accurate measurements. Includes 5 x 1g, 5 x 5g and 5 x 10g stackable weights which can be easily stored in the bottom of the base.

IP0504 \$32.50  
2 or more Each \$29.95



### Combo Balance Kit

This balance features both the large capacity pans and the large capacity 2L buckets. Compensator clips for level and accurate measurements. Includes 5 x 1g, 5 x 5g and 5 x 10g stackable weights which can be easily stored in the bottom of the base.

TFC16182 \$36.95



### 1 Block Dry Block Heater with Analog Heating Mantle

Multi-purpose dry block heaters are ideal for applications that require temperature stability. Heats up to 150°C.

SER1004605 \$809.95



### 2 Block Dry Block Heater with Analog Heating Mantle

Use this dry block heater to heat up to 150°C. Units hold optional interchangeable modular blocks with over 40 different options. Applications include incubation, enzyme reactions and more.

SER1004607 \$859.95



### 4 Block Dry Block Heater with Analog Heating Mantle

This dry block heater offers exceptional temperature uniformity and stability. Applications include Immunoassays, Activation of cultures and much more. Heats up to 150°C.

SER1004609 \$969.95



### 6 Block Dry Block Heater with Analog Heating Mantle

Multi-purpose dry block heaters are ideal for applications that require temperature stability. Applications include: melting/boiling points, isothermal incubations and much more. Heats up to 150°C.

SER1004611 \$1,099.95





**1 Block Dry Block Heater with Digital Heating Mantle**

Offering exceptional temperature uniformity and stability. This model offers stability down to 0.1°C. Applications include incubation, enzyme activation and much more. Heats up to 120°C.

SER1004604

\$899.95



**2 Block Dry Block Heater with Digital Heating Mantle**

Use this dry block heater for applications such as activation of cultures, immunoassays and much more. Accurately and efficiently heat up to temperatures of 120°C. This model offers stability down to 0.1°C.

SER1004606

\$969.95



**4 Block Dry Block Heater with Digital Heating Mantle**

Multi-purpose dry block heaters are ideal for applications that require temperature stability. This model can offer stability down to 0.1°C. Applications of this product include enzyme reactions, incubation and much more.

SER1004608

\$1,099.95



**6 Block Dry Block Heater with Digital Heating Mantle**

Offering exceptional temperature uniformity and stability. Applications include incubation, enzyme activation and much more. Heat up to 120°C. This model offers stability down to 0.1°C.

SER1004610

\$1,249.95

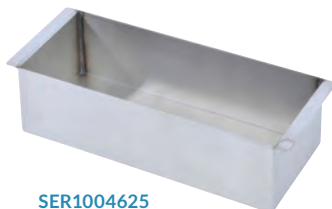

SER1004625



SER1004622



SER1004624



SER1004623

**Sand Bath for Dry Block Heater**

Blocks are anodised to resist corrosion and rust for long-term use in the lab.

- SER1004625      1 Block Unit    \$349.95
- SER1004624      2 Block Unit    \$369.95
- SER1004623      4 Block Unit    \$389.95
- SER1004622      6 Block Unit    \$399.95

## Heaters Accessories



### Dry Block Heater Module Block for Vials 16mm

This block features a thermometer well for measuring block temperature. Model type: 16mm vial, number of wells: 15, well diameter: 16.4mm, well depth: 45mm. Material: aluminium anodised.

SER1004618

\$159.95



### Dry Block Heater Module Block for Vials 21mm

This block features a thermometer well for measuring block temperature. Model type: 21mm vial, number of wells: 9, well diameter: 21.7mm, well depth: 45mm, size: 1 block, material: aluminium anodised.

SER1004621

\$159.95



### Dry Block Heater Module Block for Vials 23mm

This block features a thermometer well for measuring block temperature. Model type: 23mm vial, number of wells: 8, well diameter: 23.8mm, well depth: 45mm, size: 1 block, material: aluminium anodised.

SER1004620

\$159.95



### Dry Block Heater Module Block for Vials 25mm

This block features a thermometer well for measuring block temperature. Model type: 25mm vial, number of wells: 8, well diameter: 25.8mm, well depth: 45mm, size: 1 block, material: aluminium anodised.

SER1004619

\$159.95



### Dry Block Heater Module Block - Micro Tube Combo

This block features a thermometer well for measuring block temperature. Model type: micro tube, number of wells: 21, well diameter: 11.5mm; 11.1mm; 7.9mm, well depth: 38.1 mm; 39.1 mm; 27.6 mm, size: 1 block, material: aluminium anodised.

SER1004614

\$159.95



### Dry Block Heater Module Block for 2.0mL Test Tubes

This block features a thermometer well for measuring block temperature. Model type: 2.0 ml tube, number of wells: 20, well diameter: 11.5 mm, well depth: 38.1 mm, size: 1 block, material: aluminium anodised.

SER1004617

\$159.95



### Dry Block Heater Module Block for 10mm Test Tubes

This block features a thermometer well for measuring block temperature. number of wells: 24, well diameter: 10.7 mm, well depth: 48.4 mm, size: 1 block, material: aluminium anodised.

SER1004612

\$159.95



### Dry Block Heater Module Block for 17-18mm Test Tubes

This block features a thermometer well for measuring block temperature. Model type: 17-18 mm, number of wells: 12, well diameter: 19.1 mm, well depth: 48.4 mm, size: 1 block, material: aluminium anodised.

SER1004613

\$159.95



**Heat Controlled Heating Mantle - 6 x 500ml**

A set of 6 heating mantles, each with a 500mL capacity and individual thermometer adjusters. Capable of heating up to 6 mantles at one time.

SER1052913 Set of 6 \$699.95



SER1052912

**Heating Mantle Flask**

Easily and consistently heat up liquids with these heating flasks.

- SER1052912 100ml Flask \$249.95
- SER1052909 250ml Flask \$279.95
- SER1052910 500ml Flask \$249.95
- SER1052911 1000ml Flask \$319.95



SER1052909



SER1052910



SER1052911



**Alloy Simmerstat Hot Plate**

General purpose alloy laboratory hotplate. 'Simmerstat' temperature control provides heat adjustment from zero to full over a scale from 1 to 10. At the setting of 10, maximum plate temperature is approx 450°C. Measures 200 x 180mm. 600 watts.

SERCH1920-001 \$349.95

**Single Economy Hot Plate**

A portable single hotplate featuring variable temperature control. Dimensions: 228 x 90 x 300mm. Hot Plate diameter: 185mm. 1600W.

SER5010001 \$90.95



**Double Economy Hot Plate**

A portable double hotplate featuring variable temperature control. Dimensions: 228 x 90 x 530mm. Hot Plate diameter: 185mm. 1600W - 2400W.

SER5010002 \$110.95



## Hot Plates & Stirrers



### PTFE Simmerstat Hot Plate

General purpose PTFE laboratory hotplate. 'Simmerstat' temperature control provides heat adjustment from zero to full over a scale from 1 to 10. At the setting of 10, maximum plate temperature is approx 450°C. Measures 200 x 180mm. 600 watts.

SERCH1921-001

\$384.95



### Allow Simmerstat Hot Plate & Stirrer

Magnetic Stirrer and Hot Plate combination with 'Simmerstat' temperature control. Front panel provides the user with mains switch, heat control and speed control for stirring. Alloy top plate measures 200x180mm.

SERCH2090-001

\$499.95



### Alloy Thermostat Hot Plate

This hot plate features 'thermostat' temperature control from 50 to 320°C. The hot plate is alloy and measures: 200 x 180mm.

SERCH1922-001

\$499.95



### Hot Plate - Max Temp 500°C

The OHAUS Basic Mini Hotplates are rugged, compact units that heat up to 1000mL of liquid. Ceramic tops feature a chemical resistant white reflective top plate that is easy to clean. Pan size: 10.2 x 10.2°Cm. Max temp: 500°C

SER1004600

\$289.95



### Hot Plate with Stirrer - Max Temp 500°C

The OHAUS Basic Mini Hotplate-Stirrers are rugged, compact units that heat and stir up to 1000mL of liquid. Ceramic tops feature a chemical resistant white reflective top plate that is easy to clean. Pan size: 10.2 x 10.2°Cm. Max temp: 500°C. Stirrer: 100 - 12000rpm.

SER1004603

\$399.95



### PTFE Simmerstat Hot Plate & Stirrer

A PTFE Magnetic Stirrer and Hot Plate combined with 'simmerstat' temperature control. Front panel provides the user with mains switch, heat control and speed control for stirring. Rectangular, high temperature alloy top plate 200x180mm with PTFE (Teflon) coating to resist corrosion and for easy cleaning.

SERCH2091-001

\$599.95



### Alloy Thermostat Hot Plate & Stirrer

Magnetic Stirrer and Hot Plate combined with 'thermostat' temperature control. Front panel provides the user with mains switch, thermostat heat control from 50 to 320°C, and speed control for stirring. The high temperature alloy top plate measures 200x180mm.

SERCH2092-001

\$629.95



### PTFE Thermostat Hot Plate & Stirrer

A Magnetic Stirrer and Hot Plate combined with 'thermostat' temperature control. Front panel provides the user with mains switch, thermostat heat control from 50 to 320°C, and speed control for stirring. High temp, PTFE coated alloy top plate measures 200 x 180mm.

SERCH2093-001

\$699.95



**Magnetic Mini Stirrer -100 -1200rpm**

OHAUS Mini Hotplate Stirrers are rugged, compact units that can stir up to 1000 ml of water. These stirrers are ideal for educational and other lab environments that require consistent stirring. Pan size: 10.2 x 10.2°Cm, overall size: 20.1 x 15.2 x 12.7°Cm.

SER1004601

\$249.95



**Magnetic Mini Auto Stirrer - 100-1200rpm**

OHAUS Mini Stirrers are rugged, compact units that can stir up to 1000 ml of water at a rate of 100-1200rpm. These stirrers are ideal for educational and other lab environments that require consistent stirring. Pan size: 10.2 x 10.2°Cm, overall Size: 20.1 x 15.2 x 12.7°Cm.

SER1004602

\$299.95



**Economy Magnetic Stirrer - 0 to 2300rpm**

A light weight and compact stirrer capable of stirring at rates of 0 – 2000rpm. Suitable for stirring thin liquids up to 1000mL.

SER5009008

\$169.95



**Magnetic Epoxy Stirrer**

Magnetic Stirrer, with electronic speed control from approx. 150 to 1500 rpm. Strong magnet stirs effectively up to the viscosity of glycerine. Rectangular plate, 200x180mm, is epoxy coated to resist corrosion. Front panel provides user with the mains on/off switch and speed control.

SERCH2080-001

\$399.95



**PTFE Magnetic Stirrer**

Magnetic Stirrer, with electronic speed control from approximately 150 to 1500 rpm. Strong magnet stirs effectively up to the viscosity of glycerine. Rectangular alloy plate, 200x180mm, is PTFE (Teflon) coated to resist corrosion.

SERCH2081-001

\$379.95



**Microplate Vortex Mixer**

Microplate Vortex Mixers are designed specifically for continuous duty throughout the speed range. The high-speed and small orbit of these mixers make them optimal for effectively mixing microplates. Cup head for mixing single tubes is also included. Continuous orbit: 3.5 mm, speed range: on mode 300 – 2500rpm; touch mode: 300 – 3500rpm capacity: 2 microplates, dimensions: 11.4 cm x 26.7°Cm x 13.7°Cm.

SERVXMPAL

\$899.95

## Ovens & Incubators



**SER1023100**  
Capacity: 13L  
Weight: 8kg



**SER1023101**  
Capacity: 43L  
Weight: 16kg



**SER1023102**  
Capacity: 70L  
Weight: 24kg



**SER1023103**  
Capacity: 100L  
Weight: 32kg

### Incubator – Gravity Convection Economy

These models are economical and very easy to use making them an ideal choice for all non-critical samples requiring incubation. Features include, stainless steel lining, removable open wire chrome plated shelves, magnetic door gasket, light weight and portable, digital display. Control accuracy: 0.25°C, temp range 5 – 60°C.

SER1023100	13L	\$2,299.95
SER1023101	43L	\$2,699.95
SER1023102	70L	\$3,249.95
SER1023103	100L	\$3,949.95

### Additional Incubator Shelf

Additional incubator shelf, compatible with SER1023100, SER1023101, SER1023102, SER1023103.

SER1023103A \$99.95

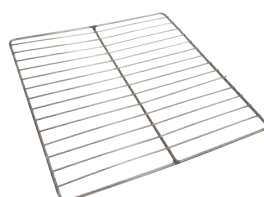

### Student-Use Oven

Oven, for student use, with thermostat control to 120°C. Stainless steel interior, type 316 for good corrosion resistance. Simple convection oven with accuracy of approx. +/-5°C. Insulated front door with simple catch and with 3 shelves adjustable for height. , internal dimensions 250x250x250mm, outer dimensions 310x330x435mm.

SERCH2250-001 \$999.95



### Fan Forced Dehydrating Oven

These economy ovens are designed and manufactured in Australia for all non-critical laboratory and light industrial functions. Featuring steel internal liners, 50mm of fibreglass insulation for energy efficiency, digital controller, removable and adjustable chrome shelving. Internal: 290 x 400 x 560 mm, external, 400 x 500 x 780 mm, temp range: 10 – 200°C, capacity 66L, weight: 37kg.

SER1023300 66L \$6,899.95



**Economy Refrigerator**

Temperature is precisely controlled electronically between +4°C and +10°C in ambients up to 32°C. The digital display incorporates high and low temperature alarms, which emit visual and audible signals to warn the operator of an alarm condition.

- SER1023400 Solid Door – 130L \$1,549.95
- SER1023403 Solid Door – 240L \$3,799.95
- SER1023401 Glass Door – 145L \$3,399.95

**SER1023400**  
 Internal: 460 x 430 x 700  
 External: 550 x 560 x 860  
 Capacity: 130L

**SER1023403**  
 Internal: 450 x 430 x 1270  
 External: 550 x 560 x 1460  
 Capacity: 240L

**SER1023401**  
 Internal: 520 x 430 x 680  
 External: 600 x 600 x 850  
 Capacity: 145L

**Economy Freezer – 20°C**

Upright freezers are ideal for samples requiring storage at -20°C. All models are fitted with a digital LAE controller, which has high and low alarms, and are both supplied standard with manual defrost. Capacity: 90L, Temperature Range: -15°C to -20°C, Temperature Control: 0.2°C.

- SER1023500 90L \$2,899.95
- SER1023501 181L \$3,599.95



**SER1023500**  
 External: 860 x 550 x 560  
 Internal: 430 x 400 x 400  
 Capacity: 90L



**SER1023501**  
 External: 1460 x 550 x 560  
 Internal: 1240 x 405 x 380  
 Capacity: 181L

**SER1020009**  
 0.7 to 1.0 specific gravity, light fluid



**SER1020008**  
 1.0 to 2.0 specific gravity, heavy fluid



**Hydrometer**

A hydrometer is an instrument that measures the specific gravity of liquids-the ratio of the density of the liquid to the density of water.

- SER1020009 Light Fluid \$9.95
- SER1020008 Heavy Fluid \$9.95
- SER1014473 Universal Range \$9.95



**SER1014473**  
 0-70/1-2.000 Specific Gravity (universal range)

## Microscopes

### Digital Microscope - USB 5MP with Software

A USB microscope with a simple but incredibly useful stand that allows students to make fine adjustments to the vertical height of the microscope and swivel the scope arm around a 360 degree range. This permits a greater level of viewing accuracy and stability. On either side of the stand there are two metal holders to lock your object in place and a printed ruler to help you get an approximate feel for the length of objects. The optics built into this microscope are excellent. The sharpness of texture on magnified objects is incredible to look at. You will spend hours searching for things to magnify. It comes with a great piece of software for capturing 5MP (2592x1944) res JPGs, BMPs, TIFFs or PNGs and 1280x960 pixel AVI files. Compatible with WinXP/ Vista/7/8, Mac 10.6-10.8. Magnification ratio: 10x, 300x (at 5MP res). Find full specifications on our website.

EL3199

\$239.95



### My First Lab™ Digital Microscope

Worth a good look! Use with the digital eyepiece and connect to a computer via the USB port or with the included standard 10X eyepiece. View live colour images, save, edit, add text and even email! Includes: Lab Microscope. Accessories: vinyl dust cover, 5 x prepared glass slides, 4 x plain slides, one concavity slide, 10 x capacity slide box, scalpel, plastic forceps, plastic dropper pipet, cover glass, replacement light bulb and lens paper. Specifications for use with a digital camera: 640 x 480 resolution, auto light contrast and fine focus, software compatible with Windows systems supporting USB (Windows 98 and up).

DC50700

\$329.95

#### Features

- 10X wide field eyepiece with pointer, three achromatic objective lenses
- 4X, 10X & 40X power
- Magnification from 40X to 400X
- 9 x 9cm stage with clips
- 6 hole disc diaphragm and easy grip knob with built in 15W illumination
- Digital Eyepiece includes:
  - USB port connection, built-in 10X lens
  - Ulead® Photo Explorer CD-ROM and 3cm adapter suitable for stereo microscope



### My First Lab™ Ultimate Microscope

A recently upgraded microscope that is now on a new base with a rechargeable battery light source. The detachable AC power cord can be used to power the light or recharge the battery for portable use "in the field". Its battery lasts for hours and can be recharged hundreds of times for years of valuable scientific research!

DC50710

\$199.95

#### Features

- Real optical glass lenses
- 10X wide field eyepiece with pointer, three achromatic objective lenses
- 4X, 10X & 40X power
- Magnification from 40X to 400X
- 9 x 9cm stage with clips, 6 hole disc diaphragm and easy grip knob
- Sturdy all-metal construction
- Includes a vinyl dust cover, five prepared glass slides and instruction manual
- 28cm(H) x 15cm(L) x 10cm(W)



### Wireless USB Digital Microscope

This extraordinary wireless hand-held digital microscope/camera is easy to use; just connect it to your computer or even your smartphone, simply using the 10m covered WiFi, and start taking videos or photos. Alternatively, you can simply use the USB to connect to your computer and use it as a normal web-cam. You can even mount it on a standard tripod (not included)!

FD079

\$114.95



### Beginner Microscope

The perfect microscope for primary grades.

EIS0002D

\$234.95

#### Features

- Mechanical tube Length: 160mm
- 45° Inclined head
- 360° Rotatable
- Eyepieces: WF 10x
- Achromatic Objectives: 4x, 10x, 40x
- Coarse and fine focus.



### Monocular Microscope

This versatile, high performance microscope comes with wide field eye pieces and provides a sharp image.

EIS007MM

\$279.95

#### Features

- Mechanical tube Length: 160mm
- 45° Inclined Head
- Rotatable 360°
- Eyepieces WF 10x
- Objectives Achromatic 4x, 10x and 40x
- Coaxial coarse and fine focus adjustment
- Stage Abbe 1.25 NA condenser with iris diaphragm
- LED illumination
- Square area 11 x 11.5cm.



### Study Scope

Designed for viewing solid or three-dimensional objects rather than traditional glass slides, this scope makes it possible for students to view virtually anything magnified 20X. (This scope does NOT let you view slides.) The binocular head allows comfortable viewing with both eyes (no more squinting) and the built-in light illuminates all specimens for premium viewing every time. Real glass optics provide high-quality images and battery power makes it portable for outdoor use. Perfect for collectors and hobbyists, it allows users to explore the infinite diversity in nature, making it an ideal – and fun – educational adventure for young and old alike. Requires 2 AA batteries (not included).

DC50702

\$129.95

#### Features

- Binocular eye tubes
- Built-in light source
- Real optical glass lenses
- 20X magnification
- Portable battery power
- Vinyl dust cover



## Microscopes



### Monocular Junior Microscope – 4/10/40x

This great monocular microscope is able to be used to view slides or to view solid objects such as leaves, rocks, etc. Forward facing nose piece with 4x 10x 40x achromatic full glass objectives.

SER1122032

4/10/40x \$229.95



### Monocular Senior Digital Microscope – 4/10/40/100x

High quality monocular microscope with built-in digital camera for whole class viewing on your smart board or monitor. 4/10/40/100x (oil immersion) objectives.

SER1122029

4/10/40/100x \$699.95



### Monocular Senior Digital Microscope – 4/10/40x

High quality monocular microscope with built-in digital camera for whole class viewing on your smart board or monitor. This model has a modern triangular base design that aids in stability, LED lighting, fine and course focusing with mechanical stage. 4x/10x/40x objectives.

SER1122028

4/10/40 \$624.95



### Monocular Senior Microscope – 4/10/40/100x

This model has a modern triangular base design that aids in stability, LED lighting, fine and course focusing with mechanical stage, iris diaphragm, 10x eyepieces and 1.25 abbe condenser. Featuring 4/10/40/100x (oil immersion) objectives, coarse and graduated fine focus adjustment.

SER1122019

4/10/40/100x \$389.95



### Monocular Senior Microscope – 4/10/40/100x

This microscope features, iris diaphragm and condenser, mechanical stage, built-in LED light, 10x wide field eyepiece and pointer, objectives: 4 10 40 100x, fine and coarse adjustment and slip clutch protection.

SER1122007

4/10/40/100x \$429.95



### Monocular Senior LED Microscope – 4/10/40

This high quality senior microscope uses the same optics as the larger cousins above, but uses simpler stage controls and a iris diaphragm. Featuring, objectives 4/10/40x, coarse and fine focus.

SER1122018A

4/10/40 \$389.95



### Monocular Junior Microscope – Large

This high quality junior microscope uses the same optics as the larger cousins above, but uses simpler stage controls and a disc type diaphragm. objectives 4/10/40x. Size 210x170x370mm.

SER1122018

4/10/40x \$299.95

**Monocular Junior External Light Microscope**

This quality junior microscope uses great optics for general educational use. This model is able to have a total magnification of 400x and uses a simple disc type diaphragm. The microscope does not have its own light source and must be used with an external source.

SER1052655 4/10/40x \$124.95



**Monocular Senior Microscope**

Featuring 4/10/40/100x (oil immersion) objectives, coarse and graduated fine focus adjustment. This model has a modern triangular base design that aids in stability, LED lighting, fine and course focusing with mechanical stage, iris diaphragm, 10x eyepieces and 1.25 abbe condenser.

SER1122014  
4/10/40/100x \$319.95



**Monocular Junior Microscope LED**

High quality junior microscope that is able to carry out all functions required of, for younger students to learn the basics of microscopy. Features: disc diaphragm, high quality lens, 4/10/40x, 400x max/ power, LED Light Source, fine and course focus.

SER1052630 4/10/40x \$229.95



**Binocular Senior Digital Microscope**

High quality binocular microscope with built-in digital camera for whole class viewing on your smart board or monitor. This model has a modern triangular base design that aids in stability, LED lighting, fine and course focusing with mechanical stage, iris diaphragm, 10x eyepieces and 1.25 abbe condenser.

SER1122025 4/10/40/100x \$999.95



**Binocular Senior Microscope**

High quality binocular microscope without the built-in digital camera of its bigger brother. This model has a modern triangular base design that aids in stability, LED lighting, fine and course focusing with mechanical stage, iris diaphragm, 10x eyepieces and 1.25 abbe condenser.

SER1122020 4/10/40x \$499.95  
SER1122021 4/10/40/100x \$629.95



**Stereoscopic Dual Light Microscope**

This stereoscope features a light source, inclined body LED illumination with variable light control, dual LED light variable sources, 10x eyepiece wide field and objectives rotate 2x and 4x, highest magnification 20 and 40X.

SER1122008 20x & 40x \$399.95



**Stereoscopic Microscope**

This stereoscope features 10x wide field eyepieces, 10x objective, total magnification 20x but no internal light source.

SER1122012 20x \$289.95



**Stereoscopic Microscope - Battery Powered**

This stereoscope features 20x magnification, 10x eyepiece, 2x objective, sturdy plastic body, and excellent glass optics.

SER1115990 20x \$149.95

## Microscopes



### Stereoscopic Dual Light Microscope – 20x

This stereoscope features 20x magnification, dual lighting, inclined body, 10x wide field eyepieces, 2x objective, 20x magnification.

SER1122064

20x \$349.95



### Stereoscopic Dual Light Microscope – 80x

Another in our series of stereoscopic microscopes, supplying a sharp image with high resolution. 80x magnification and light source, inclined body LED illumination with variable light control, LED light variable sources, 10x wide field eyepieces.

SER1122901

80x \$899.95



### Handheld Digital Microscope with Stand

This model has a modern triangular base design that aids in stability, LED lighting, fine and coarse focusing with mechanical stage, iris diaphragm, 10x eyepieces and 1.25 abbe condenser. Featuring 4/10/40/100x (oil immersion) objectives, coarse and graduated fine focus adjustment.

SER5006005

200x \$98.95



### Handheld Digital Microscope with Polariser

The Anyview USB Microscope with polarizer is a handheld colour digital microscope with high quality 2.0 megapixel image sensor. It is small, easy to operate and portable fun for professional application.

SER5006006

200x \$165.95



### Handheld Microtome with Razor

A simple, cheap way to make slides for your class or to teach students the basics of histology and how slides are made and why. This device is used for cutting thin, uniform sections of a specimen for microscopic examination.

SER1052352

\$59.95



### Microscope Cleaning Kit

Suitable for the cleaning of a camera, monocular and binocular lens, glasses and any high precision and sensitive equipment.

SER1122900

4/10/40/100x \$6.95



**Hand Bench Centrifuge**

A single speed hand driven. Consists of die casted parts and steel pinion and worm drive. Removable handle. Screw clamps to bench. Comes with 4 x 15ml tubes.

SER1010189 4 x 15ml Head \$69.95



**Economy Centrifuge**

Digitally displayed speed and range, automatic balance adjustment, 40Watt motor, safety switch when lid opened, CE European safety standard approved, parts: spare 20ml.

SER1052058 \$499.95

**Electric Vacuum Pump with Pressure Gauge**

This is a high-quality vacuum pump specifically designed for educational use, with a precision machined one-stage pump for reliable use and convenient carry handle for moving between prep or classrooms. Contents: 1x vacuum pump, 1x air filter, 1x hose fitting, 1x bottle of oil.

SER1014149 Electric with Pressure Gauge \$399.95



**Uncirculated Digital Water Bath**

Adjustable temperature range up to 100°C, accurate digital solid state temperature controller, durable colourbond construction, seamless stainless steel tank with radial corners, carry handles fitted as standard, perforated removable floor, custom baths available on request. Capacity: 12L, bath dimensions: 290 x 230 x 160mm, external: 330 x 270 x 290mm, temperature stability: +0.25°C.

SER1023610 12L \$1,529.95

## Water Baths



SER1023620B



SER1023620

### Uncirculated Digital Water Bath – 24L

This water bath features, adjustable temperature range up to 100°C and an accurate digital solid state temperature controller. Capacity: 24L, bath dimensions: 500 x 300 x 160mm, external dimensions: 530 x 330 x 290mm, temperature stability: +0.25°C.

SER1023620                      Uncirculated, Digital – 24L \$1,699.95  
 SER1023620B                 Uncirculated, Stainless Flat Lid – 24L \$139.95

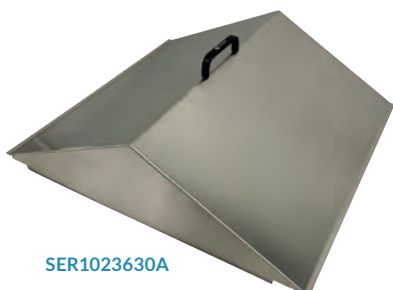

SER1023630A



SER1023630B



SER1023630

### Uncirculated Digital Water Bath – 48L

This water bath features, adjustable temperature range up to 100°C, accurate digital solid state temperature controller, durable colourbond construction, seamless stainless steel tank with radial corners, carry handles fitted as standard and a perforated removable floor. Capacity: 48L, bath dimensions: 620 x 500 x 160mm, external dimensions: 650 x 530 x 290mm, temperature stability: +0.25°C.

SER1023630                      Uncirculated, Digital – 48L \$2,479.95  
 SER1023630A                 Uncirculated, Polycarbonate Gable Lid – 48L \$689.95  
 SER1023630B                 Uncirculated, Stainless Flat Lid – 48L \$329.95



### Economy Water Bath – 8L

This might just be one of the best laboratory water baths for the money. It includes an automatic shut off and can hold temperatures within 0.2°C. Also includes a stirrer and one stainless steel rack that converts to hold 4x 250ml beakers or 15x 25mm and 15x 16mm test tubes and comes with a lid included. Internal : 29L x 23W x 15H mm.

SER1052922                      With Stirrer, Racks & Lid, 8L \$699.95  
 SER1052922NS                 Without Stirrer, Racks & Lid, 8L \$649.95

### Spare Polycarbonate Lid for Economy Water Bath

Spare polycarbonate lid for SER1052922.

SER1052922A                 \$129.95



### Spare Control Unit for Economy Water Bath

Spare Heating element and stirrer with digital control unit for SER1052922.

SER1052922B                 \$299.95



**Spare tank Element Guard for Water Bath**

Water Bath Economy, Spare Tank Element Guard.  
 SER1052922F \$99.95

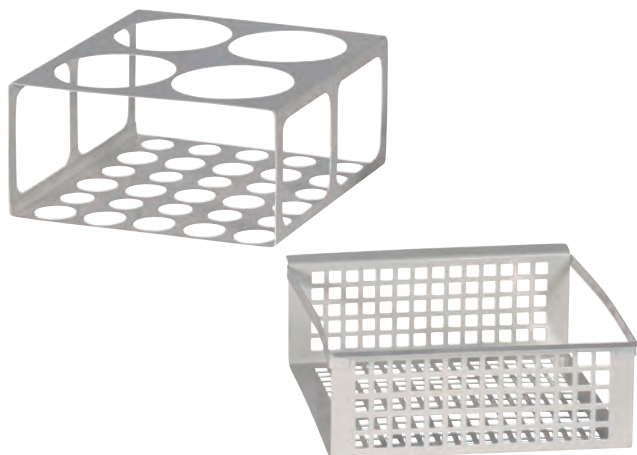

**Spare Beaker & Test Tube Rack for Economy Water Bath**

Spare beaker and test tube rack for all SER1052922 models.  
 SER1052922D \$99.95



**Spare Control Transformer for Economy Water Bath**

Spare control transformer for all SER1052922 models.  
 SER1052922E \$39.95

**Circulated Water Bath – 12L & 24L**

SER1023650C	Digital, Tub Only, 12L	\$849.95
SER1023650B	Stainless Steel Lid, 12L	\$129.95
SER1023651C	Digital, Tub Only, 24L	\$1,019.95
SER1023651A	Polycarbonate Gable Lid, 24L	\$264.95
SER1023651B	Stainless Steel Lid, 24L	\$139.95



## Water Purification

### Circulated Water Bath – 48L

Circulated water baths are ideal for applications when temperature uniformity and consistency are critical, such as enzymatic and serologic experiments. Water is thoroughly circulated throughout the bath resulting in a more uniform temperature.



SER1023652C	Digital, Tub Only, 48L	Circulated Water Bath, Digital, Tub Only, 48L.	\$1,399.95
SER1023652A	Polycarbonate Gable Lid, 48L	Circulated Water Bath, Polycarbonate Gable Lid, 48L.	\$689.95
SER1023652B	Stainless Steel Lid, 48L	Circulated Water Bath, Stainless Steel Lid, 48L.	\$329.95



### Circulator Support Bracket for Circulated Water Bath

Support bracket to mount heater circulator to circulated water baths. This item is included with the circulated water baths.

SER1023653B

\$219.95

### Digital Heater Circulator for Circulated Water Bath

Heater circulator for circulated water baths. These precision heater circulators have been designed to suit all Thermoline general purpose laboratory water baths. Models available in thermostat control or digital microprocessor control for greater precision and easy setting of temperatures to 0.1°C.

SER1023653A

\$3,499.95



SERCH4240-001



SERCH4240-101

### Water Bath & Thermostat Control

This thermostat control fits to the edge of the IEC water bath to control the hot plate so the water temperature in the water bath is held constant.

SERCH4240-001 Bath Only, Designed to fit IEC hotplate \$269.95

SERCH4240-101

Thermostat Control, for use with SERCH4240-001 \$199.95

### Glass Water Still – 4L/Hour

An affordable water still, it is ideal for laboratory purpose in schools, higher educational institutions and various industries. An efficient coil condenser to ensure cool distillate. It is made from borosilicate glass, the boiler is fitted with 3kW chromium plated heater, producing distillate flow rates up to approx. 4 litres / hour.

SER1052956

\$499.95







Set of 20  
Save  
**\$390**

**Safety Glasses – Kids-Sized**

Turn even the youngest students into real scientists! These safety glasses are perfect for young students aged 4 to 8. The glasses measure 120mm wide. Available in a set of 10 or 30.

MAJA003S Set of 10 \$29.95  
MAJA003SK Set of 30 ~~\$89.85~~ \$85.95



Set of 50  
Save  
**\$5455**



**Safety Goggles**

Protect student eyes. Constructed from durable soft plastic. Ventilated to stop fogging. Features an elastic strap. Correct size for children.

FD2400 Each \$7.95  
12 or more Each \$5.95  
FD2400K Set of 50 ~~\$397.50~~ \$342.95



Set of 30  
Save  
**\$1005**

**Clear Safety Glasses – Vented**

These clear safety glasses are made of durable polycarbonate. They fit over most prescription glasses and are vented to keep the glasses from fogging. UV protected and light weight. With impact resistant lens, conforms to ANSI Z87.1 2010 sideshield protection.

EIS0619A Each \$7.40  
EIS0619K Set of 30 ~~\$222.00~~ \$211.95



**Coloured Safety Goggles**

These fun, coloured safety goggles can be used any time students need reliable eye protection. Sized just right for your students and adjustable for adults. Set of six pairs of goggles comes in three bright, translucent colours (red, blue, and green).

LER2449 Set of 6 \$49.95



**Adjustable Safety Glasses with Brow Protector**

Safety glasses for the most extreme experiments, these are fitted with brow protection and side shields for the maximum safety.

SER1119002 \$3.20



**Economy Safety Glasses with Adjustable Arm**

These safety glasses have an adjustable arm with a length of 2cm, with a top and a side shield. These glasses have a snug fit.

SER1237039 \$2.95



**Safety Glasses with Adjustable Arm**

These safety glasses have an adjustable arm, however without the side shield on them.

SER1104034 \$15.95

## Lab Coats & Face Protection



### Adjustable Safety Glasses

SER1042004

\$3.95



### Safety Glasses Pouch Strong Vinyl

Use this strong vinyl safety glasses pouch to fit your safety glasses into.

SER1104049

\$2.95



### Full Face Shield

SER1119001

\$26.95



### Laboratory Coat

These laboratory coats are designed to be worn in the lab, and all have patch pockets on them.

SER1229004

X-Large - 126cm \$29.95

SER1229003

Large - 122cm \$29.95

SER1229002

Medium - 116cm \$29.95



### Lab Coats

These lab coats are available in 2 sizes and made of white polyester/cotton drill concealed press-stud fastenings, back vent and three large pockets.

Small: length 95cm, Chest 58cm, Arm Length 42cm. Medium length: 100cm, Chest 60cm, Arm Length 46cm.

EIS0622A

Medium \$42.95

EIS0622C

Small \$39.95



### Disposable Apron

Polyethylene disposable aprons, perfect for waterproof protection in an educational laboratory. Available in Child and Adult Sizes in packs of 100 units.

SER1044035

Adult Size \$24.95

SER1044011

Child Size \$19.95



### Rubberised Apron

These rubberised aprons come in two sizes, and have cotton tapes at the waist and neck.

SER1014596

Medium - 67 x 105cm \$15.95

SER1014595

Small - 67 x 90cm \$15.95



## Vinyl Powder-Free Gloves

These disposable vinyl gloves are comfortable to wear and are great for all food preparation and cleaning tasks. These gloves will offer protection from substances coming into direct contact with the hands and they help prevent cross contamination, allowing the user to dispose of the gloves when they are finished. These gloves are designed with quality in mind and are powder-free while still being easily able to slip on and off the hands. These gloves come in medium, large and extra-large sizes.



### Blue Vinyl Gloves

GL100VMB	Medium - Pack of 100	\$3.95
GL100VMB-10	Medium - Box of 1000	\$36.95
GL100VLB	Large - Pack of 100	\$3.95
GL100VLB-10	Large - Box of 1000	\$36.95
GL100VXLB	Extra Large - Pack of 100	\$3.95
GL100VXLB-10	Extra Large - Box of 1000	\$36.95



### Clear Vinyl Gloves

GL100VM	Medium - Pack of 100	\$3.95
GL100VM-10	Medium - Box of 1000	\$36.95
GL100VL	Large - Pack of 100	\$3.95
GL100VL-10	Large - Box of 1000	\$36.95
GL100VXL	Extra Large - Pack of 100	\$3.95
GL100VXL-10	Extra Large - Box of 1000	\$36.95



### Latex Gloves

Premium quality medical examination gloves made from latex.

SER1016006	Light Powder - Large	\$10.95
SER1016028	Non-Powder - Medium	\$10.95
SER1016027	Light Powder - Small	\$10.95



### Nitrile Flock Lined Gloves

Nitrile, flock lined, non-sterile examination gloves which are latex free.

SER1185003	Large	\$59.95
SER1185002	Medium	\$59.95
SER1185001	Small	\$59.95



### Medium Polyethylene Gloves

Multipurpose, polyethylene film keeps out moisture & chemicals.

SER1016011	\$19.95
------------	---------



### Heat Resistant Knitted Gloves

Heat protection up to 350°C to safeguard your hands from intense heat and flame.

SER1104036	\$19.95
------------	---------

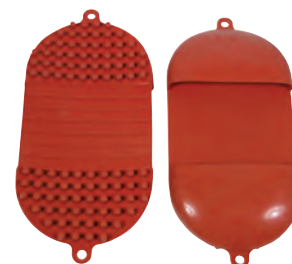

### Hot Hand Gloves

Silicon rubber gloves with pocket inserts for thumb and fingers, which will protect you when handling hot subjects in the laboratory.

SER1069010	\$12.95
------------	---------

## Sharps Containers & Jerry Cans

### Sharps Container

Sharps containers are essential in any laboratory, so that sharp objects may be disposed of accordingly.

SER1016154	Rectangular - 6.3L	\$29.95
SER1016242	Yellow Square - 4-4.8L	\$29.95
SER1016044	Yellow, NSL - 3L	\$19.95
SER1016049	Yellow Round - 20-23L	\$55.95
SER1016041	Yellow Square - 1.7-2L	\$11.95
SER1016052	Yellow, NSL - 3L	\$18.95
SER1016029	Disposable - 10 Litre	\$42.95



### Yellow Square Sharps Container - 10-12.5L

Sharps containers are essential in any laboratory, so that sharp objects may be disposed of accordingly.

SER1016043	10-12.5L	\$39.95
------------	----------	---------



### Mount Bracket for Sharps Container - 1.4L

Mount bracket for 1.4L sharps container.

SER1016053	1.4L	\$59.95
------------	------	---------



### HDPE Jerrycan

Heavy duty HDPE jerrycans, suitable for storage and transport of most liquids. Available in 3 sizes, 1L, 2.5L & 5L. Use with lid (SER4001012)

SER4001001	38-410	\$3.95
SER4001002	38TE - 5L	\$2.95
SER4001003	38TE - 1L	\$2.50



### Wedge Seal Cap

Jerrycan wedge seal cap. Compatible with SER4001001, SER4001002, SER4001003)

SER4001012	38-410 - Fit Jerrycans	\$0.50
------------	------------------------	--------

**First Aid Response Kit – High Risk Areas**



Ideal general purpose First Aid kit for your science lab or other areas where you have higher risks for burn, eye and outdoor injuries. Includes Eye 'n' Wound, burn and outdoor modules for catering to specific injury risks in these areas. Complies with WHS 2015 Regulations for Workplaces, high risk 1-25 persons. Supplied in soft pack.

FA0006

\$179.95



**Safety Screen with Wings**

Safety screens are used in many chemistry and physics lessons to protect pupils and teachers from being struck by debris or objects from demonstrations. Made from perspex to ensure the protection of students and teachers. Measures 50cm x 61cm x 4mm.

SER1104048

\$199.95

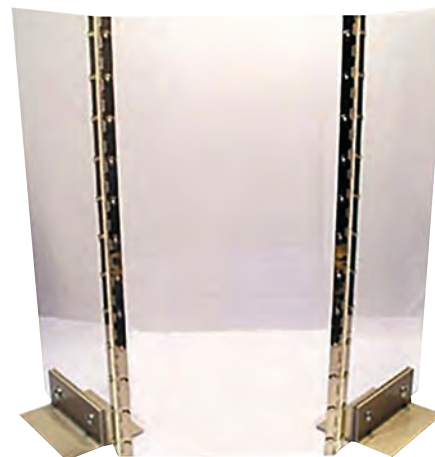

**Safety For Students Chart**

This chart depicts the Do's and Don'ts of junior safety. Measures 76 x 52 cm.

SER1242002

\$9.95



**Laboratory Safety Chart**

Classroom size 75 x 100cm. Printed on polyart plastic sheet, coloured, fitted with plastic roller. Furnishing vital safety information, instantly full time reinforcement of safe laboratory conduct.

EIS0598A

\$29.95

## Hazard Labels

### Hazard Labels

Hazard labels are used in science laboratories so that anyone using or disposing of a certain substance can be aware of the environmental and health impacts. This allows students and teachers alike to safely use chemicals within the laboratory.



#### Compressed Gas Label

SER1117020 50mm \$11.95  
SER1117007 20mm \$9.95



#### Explosive Label

SER1117021 50mm - Pack of 48 \$11.95  
SER1117004 20mm - Pack of 50 \$9.95



#### Flammable Label

SER1117024 100mm - Pack of 20 \$16.95  
SER1117023 50mm - Pack of 48 \$11.95  
SER1117005 20mm - Pack of 50 \$9.95



#### Corrosive Label

SER1117025 100mm - Pack of 20 \$16.95  
SER1117019 50mm - Pack of 48 \$11.95  
SER1117008 20mm - Pack of 50 \$9.95



#### Oxidising Label

SER1117026 100mm - Pack of 20 \$16.95  
SER1117022 50mm - Pack of 48 \$11.95  
SER1117006 20mm - Pack of 50 \$9.95



#### Environmental Toxicity Label

SER1117030 100mm \$16.95  
SER1117015 50mm \$11.95  
SER1117014 20mm \$9.95



#### Toxic Label

SER1117029 100mm - Pack of 20 \$16.95  
SER1117018 50mm - Pack of 48 \$11.95  
SER1117009 20mm - Pack of 50 \$9.95



#### Irritant Label

SER1117017 50mm - Pack of 48 \$11.95  
SER1117011 20mm - Pack of 50 \$9.95



#### Health Hazard Label

SER1117016 50mm \$11.95  
SER1117012 20mm \$9.95



## Gratnells Storage Solutions

Gratnells are the undisputed king of laboratory storage solutions, with over 125 years in the same family you get

very good at your craft! Gratnells cater for all your storage needs whether it be a trolley for taking between labs day in day out, or a 2 column shelf that sits quietly in the back of the storeroom for years, Gratnells has you covered. You can browse our site for the pre made kit that suits your needs, or if you have more creative needs, we are happy to customise your Gratnells as well.



### Shallow Gratnells Tray

Measures 31 x 43 x 7.5 cm

SERF1-S-CH	Charcoal	\$9.95
SERF1-S-CB	Cyan Blue	\$9.95
SERF1-S-FR	Flame Red	\$9.95
SERF1-S-FP	Fuchsia Pink	\$9.95
SERF1-S-GG	Grass Green	\$9.95
SERF1-S-JB	Jet Black	\$9.95
SERF1-S-LJ	Lime Jolly	\$9.95
SERF1-S-PP	Plum Purple	\$9.95
SERF1-S-RB	Royal Blue	\$9.95
SERF1-S-SY	Sunshine Yellow	\$9.95
SERF1-S-T	Translucent	\$9.95
SERF1-S-TO	Tropical Orange	\$9.95



### Deep Gratnells Tray

Measures 31 x 43 x 15 cm

SERF2-D-CH	Charcoal	\$14.95
SERF2-D-CB	Cyan Blue	\$14.95
SERF2-D-FR	Flame Red	\$14.95
SERF2-D-FP	Fuchsia Pink	\$14.95
SERF2-D-GG	Grass Green	\$14.95
SERF2-D-JB	Jet Black	\$14.95
SERF2-D-LJ	Lime Jolly	\$14.95
SERF2-D-PP	Plum Purple	\$14.95
SERF2-D-RB	Royal Blue	\$14.95
SERF2-D-SY	Sunshine Yellow	\$14.95
SERF2-D-T	Translucent	\$14.95
SERF2-D-TO	Tropical Orange	\$14.95



### Extra Deep Gratnells Tray

Measures 31 x 43 x 22.5 cm

SERF25-ED-CB	Cyan Blue	\$15.95
SERF25-ED-FP	Fuchsia Pink	\$15.95
SERF25-ED-FR	Flame Red	\$15.95
SERF25-ED-GG	Grass Green	\$15.95
SERF25-ED-JB	Jet Black	\$15.95
SERF25-ED-LJ	Lime Jolly	\$15.95
SERF25-ED-PP	Plum Purple	\$15.95
SERF25-ED-RB	Royal Blue	\$15.95
SERF25-ED-SY	Sunshine Yellow	\$15.95
SERF25-ED-T	Translucent	\$15.95
SERF25-ED-TO	Tropical Orange	\$15.95



### Jumbo Gratnells Tray

Measures 31 x 43 x 30 cm

SERF3-J-CB	Cyan Blue	\$19.95
SERF3-J-FR	Flame Red	\$19.95
SERF3-J-FP	Fuchsia Pink	\$19.95
SERF3-J-GG	Grass Green	\$19.95
SERF3-J-JB	Jet Black	\$19.95
SERF3-J-LJ	Lime Jolly	\$19.95
SERF3-J-PP	Plum Purple	\$19.95
SERF3-J-RB	Royal Blue	\$19.95
SERF3-J-Y	Sunshine Yellow	\$19.95
SERF3-J-T	Translucent	\$19.95



### Lid for F Series Gratnells Tray

Perfect for storing your apparatus or kits away from dust and damage. Compatible with all 31 x 43 cm sized Gratnells Trays.

SERLF1-LID

\$7.95



## Inserts

**Customisable Gratnells Foam Insert**

Customise and make your own foam insert. This clever foam insert has 20mm squares scored into it – so you just need to pop out some foam to make exactly the shape of insert you need.

SERFOAM-CUST

\$13.95

**Gratnells Foam Insert for 56 Test Tubes**

A useful foam insert that allows you to carefully store lab test tubes. 56 compartments. Fits shallow and deep trays only. Compartments measurements are 24mm in diameter, 60mm height, 270mm width, 385mm depth.

SERFOAM-TT-56

\$13.95

**Gratnells Foam Insert for 108 Test Tubes**

A useful foam insert that allows you to carefully store lab test tubes. 108 compartments. Fits deep trays only. Compartments measurements are 24mm in diameter, 60mm height.

SERFOAM-TT-108

\$13.95

**Gratnells Foam Insert for 30 45mm Bottles**

Foam tray insert for 30 bottles 45mm in diameter. Dimensions: height: 30mm x width: 275mm x depth: 385mm. For use with Deep Gratnells Trays.

SERFOAM-BOT-45

\$13.95

**Gratnells Foam Insert for 30 48mm Bottles**

Foam tray insert for 30 Bottles 45mm in diameter. Dimensions: height: 30mm x width: 275mm x depth, 385mm. For use with a Deep Gratnells Trays.

SERFOAM-BOT-48

\$13.95

**Gratnells Foam Insert for 20 Safety Glasses**

Foam tray insert for 20 wrap around safety glasses. Mainly for use with F2 Deep Trays. Dimensions: height: 60mm, weight: 275mm, depth 385mm.

SERFOAM-SAF-20

\$13.95



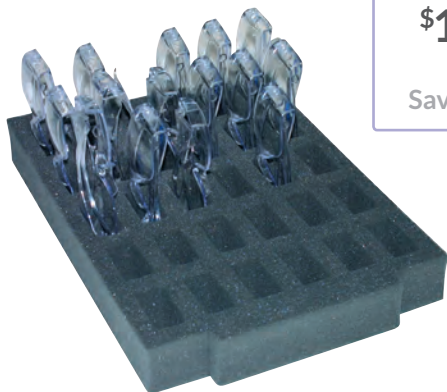

~~\$132.85~~  
**\$114<sup>95</sup>**  

---

 Save \$17.90

### Gratnells Safety Glasses Kit

This Safety Glasses storage set includes, 1 x Gratnells Deep Tray, 1 x Gratnells tray lid, 1 x Foam insert and 30 safety glasses.

SER1099106

\$114.95

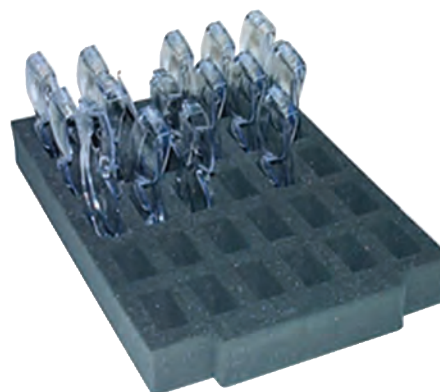

### Gratnells Foam Insert for 30 Safety Glasses

Foam tray insert for 30 safety glasses. Mainly for use with Deep Gratnells Trays. Dimensions: height: 35mm, width: 255mm, depth: 385mm.

SERFOAM-SAF-30

\$13.95



### Gratnells Foam Insert for 30 Stopwatches

Foam tray insert for 30 stop watches. Mainly for use with Deep Gratnells Trays. Dimensions: height: 35mm, width: 255mm, depth: 385mm.

SERFOAM-SP-30

\$13.95



### Gratnells Foam Insert for 15 Calculators

Foam tray insert for 15 calculators. Dimensions: height: 50mm x width: 275mm x depth: 385mm. Mainly for use with Gratnells Deep Trays.

SERFOAM-CAL-15

\$13.95

### Wire Mesh Gratnells Inserts

This is a sturdy wire mesh insert used to hold test tubes. It can hold up to 108 test tubes with 25mm diameter. Made from coppered steel wire with white nylon coat or stainless steel. Suitable for Deep, Extra Deep and Jumbo Trays.

SER5011015D

\$99.95



## Frames

~~\$858.95~~  
**\$679<sup>95</sup>**  
 Save \$179.00



### Gratnells Double Column Frame 1850mm - F3

This is a Gratnells double column frame storage system. It measures 1850mm. This includes 1 double column frame in silver, 10 Jumbo trays; 10 pairs of runners. Dimensions: height - 1850mm, width - 710mm, depth - 420mm.

SER2625-KIT-1 \$679.95

~~\$1,356.55~~  
**\$1,049<sup>95</sup>**  
 Save \$306.60



### Gratnells Double Column Frame 1850mm - F1

This is a Gratnells double column frame storage system. It measures 1850mm. This includes 1 double column frame in silver, 34 Shallow trays; 34 pairs of runners. Dimensions: height - 1850mm, width - 710mm, depth - 420mm.

SER2625-KIT-2 \$1,049.95

~~\$1,097.95~~  
**\$849<sup>95</sup>**  
 Save \$248.00



### Gratnells Double Column Frame 1850mm - F1 & F2

This is a Gratnells double column frame storage system. It measures 1850mm. This includes 1 double column frame in silver, 2 Shallow trays, 18 Deep Trays, 20 pairs of runners. Dimensions: height - 1850mm, width - 710mm, depth - 420mm.

SER2625-KIT-3 \$849.95

~~\$1,079.95~~  
**\$840<sup>95</sup>**  
 Save \$239.00



### Gratnells Double Column Frame 1850mm - All Trays

This is a Gratnells double column frame storage system. It measures 1850mm. This includes 1 double column frame in silver, 8 Shallow trays, 8 Deep Trays, 2 Extra Deep Trays; 2 Jumbo Trays; 20 pairs of runners. Dimensions: height - 1850mm, width - 710mm, depth - 420mm.

SER2625-KIT-4 \$840.95

~~\$1,247.75~~  
**\$969<sup>95</sup>**  
 Save \$277.80



### Gratnells Tall Double Column Frame Kit - F1

This is a Gratnells double column frame storage system. It measures 1850mm. This includes 1 double column frame in silver, 20 Shallow trays, 4 shelves; 20 pairs of runners. Dimensions: height - 1850mm, width - 710mm, depth - 420mm.

SER2625-KIT-5 \$969.95

~~\$1,108.55~~  
**\$896<sup>95</sup>**  
 Save \$211.60



### Gratnells Tall Double Column Frame Kit - F2

This is a Gratnells double column frame storage system. It measures 1850mm. This includes 1 double column frame in silver, 12 Deep trays, 4 shelves; 12 pairs of runners. Dimensions: height - 1850mm, width - 710mm, depth - 420mm.

SER2625-KIT-6 \$896.95

~~\$1,038.75~~  
**\$835<sup>95</sup>**

Save \$202.80

**Gratnells Tall Double Column Frame Kit - F1 & F2**

This is a Gratnells double column frame storage system. It measures 1850mm. This includes 1 double column frame in silver, 2 Shallow trays, 8 Deep trays, 4 shelves; 10 pairs of runners. Dimensions: height - 1850mm, width - 710mm, depth - 420mm.

SER2625-KIT-7 **\$835.95**

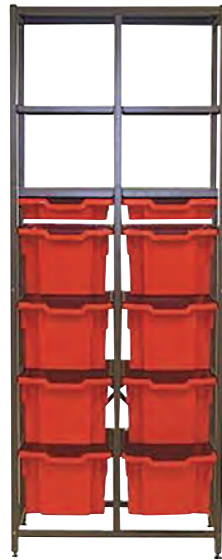

~~\$1,171.75~~  
**\$904<sup>95</sup>**

Save \$266.80

**Gratnells Tall Double Column Frame Kit - F1 & F25**

This is a Gratnells double column frame storage system. It measures 1850mm. This includes 1 double column frame in silver, 20 Deep trays, 4 Extra Deep trays, 4 shelves and 20 pairs of runners. Dimensions: height - 1850mm, width - 710mm, depth - 420mm.

SER2625-KIT-8 **\$904.95**



**Gratnells Tall Triple Column Frame**

A heavy duty storage frame for your classroom or laboratory. This frame can hold any of the 31 x 43cm Gratnells trays. Includes: metal top, heavy duty frame, rubber feet. Dimensions: height: 1850mm, width: 1055mm, depth: 420mm.

SER3625-1850-S **\$609.95**

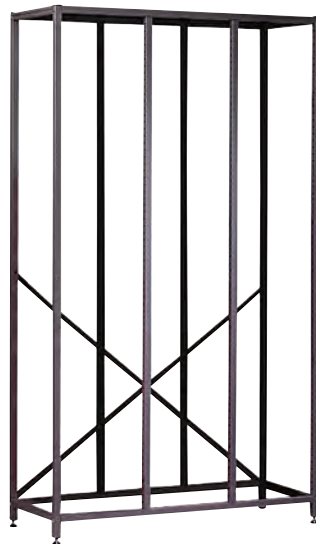

**Gratnells Tall Triple Column Frame Kit - F1**

This is a Gratnells triple storage frame kit that measures 1850mm. This includes 1 triple column frame in silver, 51 Shallow trays and; 51 runners. Dimensions: height - 1850mm, width - 1055mm, depth - 420mm.

SER3625-KIT-1K **\$1,599.95**



~~\$1,507.85~~  
**\$1,219<sup>95</sup>**

Save \$287.90

**Gratnells Tall Triple Column Frame Kit 1850mm - F2**

This is a Gratnells triple storage frame kit that measures 1850mm. This includes 1 triple column frame in silver, 18 Deep trays, 6 shelves and; 18 runners. Dimensions: height - 1850mm, width - 1055mm, depth - 420mm.

SER3625-KIT-2 **\$1,219.95**

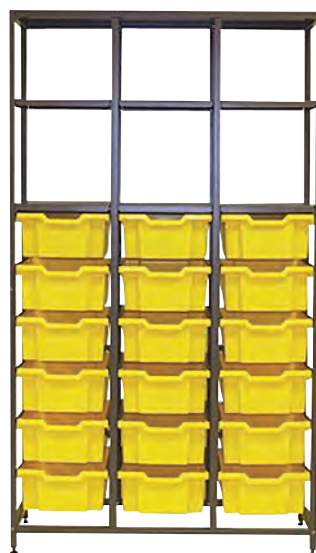

~~\$1,370.30~~  
**\$1,079<sup>95</sup>**

Save \$290.35

**Gratnells Tall Triple Column Frame Kit 1850mm - F1 & F25**

This is a Gratnells triple storage frame kit that measures 1850mm. This includes 1 triple column frame in silver, 3 Shallow trays, 12 Extra Deep trays, 6 shelves and; 12 runners. Dimensions: height - 1850mm, width - 1055mm, depth - 420mm.

SER3625-KIT-3 **\$1,079.95**



## Frames

~~\$1,133.45~~  
**\$899<sup>95</sup>**

Save \$233.50

### Gratnells Tall Triple Column Frame Kit - F3

This is a Gratnells triple storage frame kit that measures 1850mm. This includes 1 triple column frame in silver, 15 Jumbo trays and 15 runners. Dimensions: height - 1850mm, width - 1055mm, depth - 420mm.

SER3625-KIT-4 **\$899.95**

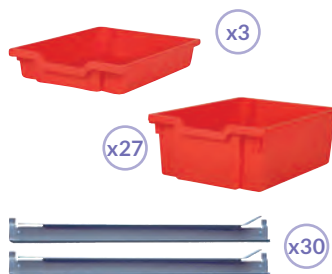

### Gratnells Tall Triple Column Frame Kit - F1 & F2

This is a Gratnells triple storage frame kit that measures 1850mm. This includes 1 triple column frame in silver, 3 Shallow trays, 27 Deep trays and; 30 runners. Dimensions: height - 1850mm, width - 1055mm, depth - 420mm.

SER3625-KIT-5K **\$1,299.95**

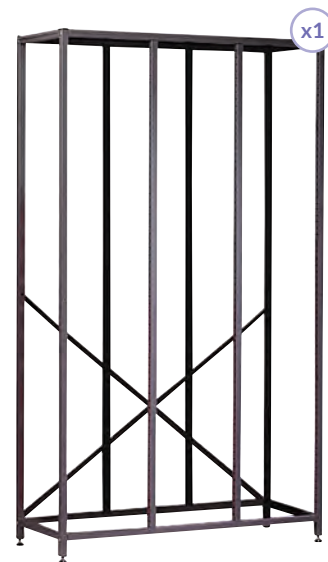

### Gratnells Tall Triple Column Frame Kit

This is a Gratnells triple storage frame kit that measures 1850mm. This includes 1 triple column frame in silver, 15 Deep trays, 6 Extra Deep trays, 3 Jumbo trays & 24 runners. Dimensions: height - 1850mm, width - 1055mm, depth - 420mm.

SER3625-KIT-6K **\$1,199.95**



~~\$1,791.35~~  
**\$1,424<sup>95</sup>**

Save \$366.40

### Gratnells Tall Triple Column Frame Kit - F1

This is a Gratnells triple storage frame kit that measures 1850mm. This includes 1 triple column frame in silver, 33 Shallow trays, 6 shelves & 33 runners. Dimensions: height - 1850mm, width - 1055mm, depth - 420mm.

SER3625-KIT-7 **\$1,424.95**



~~\$1,464.95~~  
**\$1,134<sup>95</sup>**

Save \$330.00

### Gratnells Tall Triple Column Frame Kit - All Trays

This is a Gratnells triple storage frame kit that measures 1850mm. This includes 1 triple column frame in silver, 12 Shallow trays, 12 Deep trays, 3 Extra Deep trays, 3 Jumbo trays & 30 runners. Dimensions: height - 1850mm, width - 1055mm, depth - 420mm.

SER3625-KIT-8 **\$1,134.95**



### Gratnells Tall Wide Treble Frame

A heavy duty storage frame for your classroom or laboratory. This frame can hold any of the 31 x 43cm Gratnells trays. Includes: metal top, back bars, heavy duty frame, rubber adjustable feet. Dimensions: height: 1850mm, width: 1055mm, depth: 420mm. Suitable for storing larger items.

SER3622-1850-S **\$481.95**

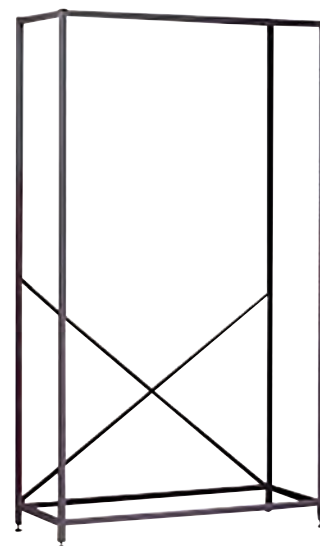

~~\$1,081.75~~  
**\$899.95**  
 Save \$181.80



**Gratnells Wide Treble Frame with Shelves**

This is a Gratnells wide treble frame in silver. It measures 1850mm tall. Includes 1 frame & 4 shelves.

SER3622-KIT-1 \$899.95

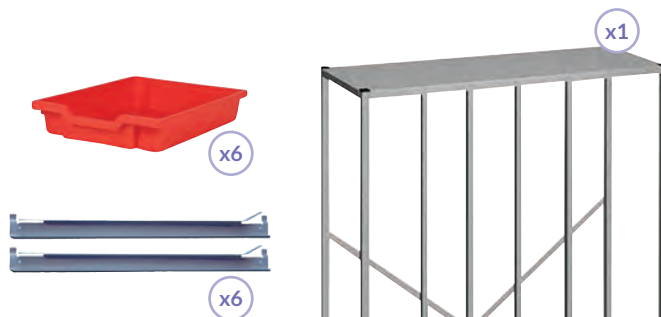

**Gratnells Triple Column Frame 1500mm - F1**

This is a Gratnells triple column frame storage kit that measures 1500mm. This includes 1 triple column frame, 6 Shallow trays & 6 runners.

SER3622-KIT-2K \$649.95



**Gratnells Low Treble Frame - 725mm**

A heavy duty storage frame for your classroom or laboratory. This frame can hold any of the 31 x 43cm Gratnells trays. Includes: metal top, heavy duty frame, rubber feet. Dimensions: Height: 725mm. Width: 1055mm. Depth: 420mm.

SER3325-725-S \$509.95



**Gratnells Low Treble Frame - 825mm**

Gratnells Frame Low Treble Silver 825 mm

SER3325-825-S \$509.95



**Gratnells Mid Treble Column Frame - 1500mm**

A heavy duty storage frame for your classroom or laboratory. This frame can hold any of the 31 x 43cm Gratnells trays. Includes: Metal top, Heavy duty frame, Rubber feet. Dimensions: Height: 1500mm, Width: 1055mm, Depth: 420mm.

SER3525-1500-S \$612.95



**Gratnells Wide Double Frame**

Gratnells Frame, Wide Double-Silver. measures:1850 mm

SER2622-1850-S \$409.95

## Frames &amp; Shelves

~~\$929.75~~  
\$649<sup>95</sup>

Save \$279.80

### Gratnells Wide Double Frame with Shelves

This is a Gratnells wide double frame in silver. It measures 1850mm tall. Includes 1 frame & 4 shelves.

SER2622-1850-SK \$649.95



~~\$1,584.05~~  
\$1,169<sup>95</sup>

Save \$414.10

### Gratnells Triple Column Frame - 1500mm

This is a gratnells triple column frame storage kit that measures 1500mm. This includes 1 triple column frame, 39 Shallow trays & 39 runners.

SER3525-KIT-1 \$1,169.95



### Gratnells Double Trolley Kit - 725mm

This is a Gratnells double column trolley storage set in silver. It measures 725mm. This includes 1 trolley, 10 Shallow trays, 4 Deep Trays & 6 pairs of runners. Dimensions: height - 725mm, width - 710mm, depth - 420mm.

SER2022-KIT-2K \$599.95



### Gratnells Triple Column Frame - 1500mm

A heavy duty storage frame for your classroom or laboratory. This frame can hold any of the 31 x 43cm Gratnells trays. Includes: metal top, heavy duty frame, rubber feet. Dimensions: height: 1850mm, width: 710mm, depth: 420mm.

SER2625-1850-S \$509.95

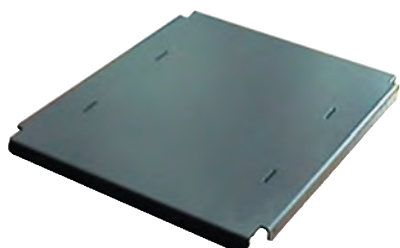

### Gratnells Single Width Shelf

Single shelf with clips for use in Gratnells frames and trolleys. Width: 335mm x depth: 420mm. Comes with mounting clips.

SERSHELF-361

\$59.95

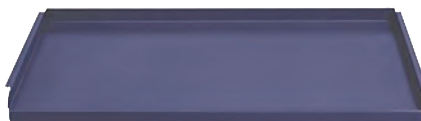

### Gratnells Double Width Shelf

Double metal shelf for use in Gratnells double-width wide frames and trolleys. Supplied in packs of 2 with clips. Width: 645mm x depth: 420mm.

SERSHELF-362

\$129.95

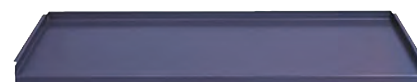

### Gratnells Treble Width Shelf

Wide shelf for use in Gratnells wide frames and trolleys only (ref 3020, 3022 and 3622). Width: 1055mm x depth: 420mm x height 40mm. Supplied in packs of 2 with clips.

SERSHELF-363

\$149.95



### Heavy Duty Light Weight Trolley - 2 Shelf

Designed for laboratory use, these great trolleys are made to handle a hard life being pushed around carrying a heavy load. They are great for storing class sets of microscopes, power supplies and general apparatus. Included in the design is a thoughtful lip around the edge of each shelf, specially designed to stop anything sliding off while moving between prep rooms and remote laboratories. Designed to carry 250kg. Durable heavy duty construction. Two swivel wheels and 2 locking brakes. Lightweight for easy mobility.

SER7002001

\$299.95



### Heavy Duty Light Weight Trolley - 3 Shelf

Designed for laboratory use, these great trolleys are made to handle a hard life being pushed around carrying a heavy load. They are great for storing class sets of microscopes, power supplies and general apparatus. Included in the design is a thoughtful lip around the edge of each shelf, specially designed to stop anything sliding off while moving between prep rooms and remote laboratories. Designed to carry 250kg. Durable heavy duty construction. Two swivel wheels and 2 locking brakes. Lightweight for easy mobility.

SER7002002

\$359.95



### Heavy Duty Metal Lab Trolley - 3 Shelf

Heavy duty steel trolley with four wheels, including two fitted with brakes. Chemical resistant paint. Supplied in flat pack. Size: 1040 x 440 x 1010cm

SER1181001

\$519.95



### Double Width Trolley - 725mm

A heavy duty storage frame for your classroom or laboratory. This frame can hold any of the 31 x 43cm Gragnells trays. Now you can transport all your equipment from the store to the classroom and back again with ease. Our shelved trolleys have been specially designed to store large or wide items. We can supply any combination of coloured trays from our range. Includes: metal top, 4x castors (wheels). Dimensions: height: 850mm, width: 370mm, depth: 420mm.

SER2022-850-S

\$399.95

### Treble Combination Trolley - 725mm

A heavy duty storage frame for your classroom or laboratory. This frame can hold any of the 31 x 43cm Gragnells trays. Now you can transport all your equipment from the store to the classroom and back again with ease. Our shelved trolleys have been specially designed to store large or wide items. Dimensions: height: 725mm, width: 710mm, depth: 420mm.

SER3020-725-S

\$409.95



## Trolleys



### Treble Combination Trolley - 850mm

A heavy duty storage frame for your classroom or laboratory. This frame can hold any of the 31 x 43cm Gragnells trays. Now you can transport all your equipment from the store to the classroom and back again with ease. Our shelved trolleys have been specially designed to store large or wide items. Dimensions: height: 850mm, width: 710mm, depth: 420mm.

SER3020-850-S

\$509.95

Save  
**\$35<sup>95</sup>**



### Gragnells Triple Trolley with Shelves - 725mm

This is a Gragnells triple column trolley storage system. It measures 725mm. This includes 1 triple column trolley in silver & 1 shelf. Dimensions: height - 725mm, width - 1055mm, depth - 420mm.

SER3020-725-SK

~~\$559.90~~ \$523.95

Save  
**\$189<sup>45</sup>**



### Gragnells Triple Trolley Storage Unit - 750mm

This is a Gragnells triple trolley storage unit that measures 750mm. It includes 1 triple width trolley in silver, 1 triple width shelf, 1 double width shelf, 2 Shallow trays, 2 Deep trays & 4 runners.

SER3020-850-SK

~~\$899.40~~ \$709.95

Save  
**\$43<sup>95</sup>**



### Gragnells STEM Triple Trolley with Shelves - 725mm

This kit includes a storage frame and shelves. A heavy duty storage frame for your classroom or laboratory. This frame can hold any of the 31 x 43cm Gragnells trays. Now you can transport all your equipment from the store to the classroom and back again with ease. Our shelved trolleys have been specially designed to store large or wide items. Includes: metal top, 4x castor (wheels). Dimensions: height: 725mm, width: 1055mm, depth: 420mm.

SER3022-KIT-1

~~\$544.90~~ \$500.95

Save  
**\$37<sup>95</sup>**

### Gragnells STEM Triple Trolley with Shelves - 850mm

This kit includes a storage frame and shelves. A heavy duty storage frame for your classroom or laboratory. This frame can hold any of the 31 x 43cm Gragnells trays. Now you can transport all your equipment from the store to the classroom and back again with ease. Our shelved trolleys have been specially designed to store large or wide items. Includes: metal top, 4x castors (wheels). Dimensions: height: 850mm, width: 1055mm, depth: 420mm.

SER3022-KIT-2

~~\$529.90~~ \$491.95







**Treble Width Trolley - 725mm**

A heavy duty storage frame for your classroom or laboratory. This frame can hold any of the 31 x 43cm Gratnells trays. Now you can transport all your equipment from the store to the classroom and back again with ease. Our shelved trolleys have been specially designed to store large or wide items. Includes: metal top, 4x castor (wheels). Dimensions: height: 725mm, width: 1055mm, depth: 420mm.

SER3022-725-S

\$394.95



**Treble Width Trolley - 850mm**

A heavy duty storage frame for your classroom or laboratory. This frame can hold any of the 31 x 43cm Gratnells trays. Now you can transport all your equipment from the store to the classroom and back again with ease. Our shelved trolleys have been specially designed to store large or wide items. Includes: metal top, 4x castors (wheels). Dimensions: height: 850mm, width: 1055mm, depth: 420mm.

SER3022-850-S

\$379.95



**Gratnells Triple Column Trolley - 850mm, F1 & F2 & F25**

This is a Gratnells triple column trolley storage system. It measures 850mm. This includes 1 triple column trolley in silver, 3 Shallow trays, 3 Deep trays, 3 Jumbo trays & 9 pairs of runners. Dimensions: height - 850mm, width - 1055mm, depth - 420mm.

SER3025-KIT-1K

\$649.95



**Gratnells Triple Column Trolley - 850mm, F1 & F2**

This is a Gratnells triple column trolley storage system. It measures 850mm. This includes 1 triple column trolley in silver, 3 Shallow trays, 9 Deep trays & 12 pairs of runners. Dimensions: height - 850mm, width - 1055mm, depth - 420mm.

SER3025-KIT-2K

\$769.95

~~\$1,010.15~~  
**\$782<sup>95</sup>**  
 Save \$227.20

**Gratnells Triple Column Trolley - 850mm, F1**

This is a Gratnells triple column trolley storage system. It measures 850mm. This includes 1 triple column trolley in silver, 18 Shallow trays & 18 pairs of runners. Dimensions: height - 850mm, width - 1055mm, depth - 420mm.

SER3025-KIT-3

\$782.95



## Trolleys

\$769.05  
**\$602<sup>95</sup>**  
 —  
 Save **\$166.10**

### Gratnells Triple Column Trolley - 725mm, F1 & F2

This is a Gratnells triple column trolley storage system. It measures 725mm. This includes 1 triple column trolley in silver, 3 Shallow trays, 6 Deep trays & 9 pairs of runners. Dimensions: height - 725mm, width - 1055mm, depth - 420mm.

SER3025-KIT-4

\$602.95



Save  
**\$27<sup>45</sup>**

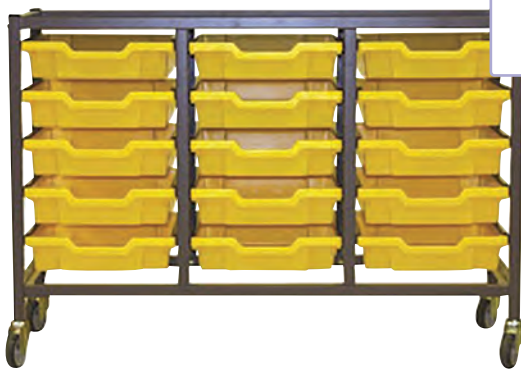

### Gratnells Triple Column Trolley - 725mm, F1

This is a Gratnells triple column trolley storage system. It measures 725mm. This includes 1 triple column trolley in silver, 6 Shallow trays & 6 pairs of runners. Dimensions: height - 725mm, width - 1055mm, depth - 420mm.

SER3025P-KIT-1

~~\$179.40~~ \$151.95

### Gratnells Treble Column Trolley - 850mm

A heavy duty storage frame for your classroom or laboratory. This frame can hold any of the 31 x 43cm Gratnells trays. Now you can transport all your equipment from the store to the classroom and back again with ease. Our shelved trolleys have been specially designed to store large or wide items. Includes: metal top, 4x castors (wheels). Dimensions: height: 850mm, width: 1055mm, depth: 420mm.

SER3025-850-S

\$561.95



### Gratnells Treble Column Trolley - 725mm

A heavy duty storage frame for your classroom or laboratory. This frame can hold any of the 31 x 43cm Gratnells trays. Now you can transport all your equipment from the store to the classroom and back again with ease. Our shelved trolleys have been specially designed to store large or wide items. Includes: metal top, 4x castors (wheels). Dimensions: height: 725mm, width: 1055mm, depth: 420mm.

SER3025-725-S

\$514.95



\$414.65  
**\$399<sup>95</sup>**  
 —  
 Save **\$14.70**

### Gratnells Single Column Trolley - 750mm, F1 & F2

This is a Gratnells single column trolley storage set in silver. It measures 750mm. This includes 1 trolley, 1 Shallow tray, 2 Deep trays & 3 pairs of runners. Dimensions: height - 750mm, width - 370mm, depth - 420mm.

SER1025-KIT-3

\$399.95



~~\$539.35~~  
**\$519<sup>95</sup>**  
 Save \$19.40

**Gratnells Single Column Trolley - 850mm, F1**  
 This is a Gratnells single column trolley storage set in silver. It measures 850mm. This includes 1 trolley, 6 Shallow trays & 6 pairs of runners. Dimensions: height - 850mm, width - 370mm, depth - 420mm.  
**SER1025-KIT-4** **\$519.95**



~~\$504.55~~  
**\$407<sup>95</sup>**  
 Save \$96.60

**Gratnells Single Column Trolley - 850mm, F1 & F2**  
 This is a Gratnells single column trolley storage set in silver. It measures 850mm. This includes 1 trolley, 1 Shallow tray, 3 Deep trays & 4 pairs of runners. Dimensions: height - 750mm, width - 370mm, depth - 420mm.  
**SER1025-KIT-5** **\$407.95**



~~\$454.45~~  
**\$372<sup>95</sup>**  
 Save \$81.50

**Gratnells Single Column Trolley - 750mm, F1**  
 This is a Gratnells single column trolley storage set in silver. It measures 750mm. This includes 1 trolley, 5 Shallow trays & 5 pairs of runners. Dimensions: height - 750mm, width - 370mm, depth - 420mm.  
**SER1025-KIT-6** **\$372.95**



~~\$659.85~~  
**\$499<sup>95</sup>**  
 Save \$159.90

**Gratnells Double Column Trolley - 725mm, F1**  
 This is a Gratnells double column trolley storage set in silver. It measures 725mm. This includes 1 trolley, 10 Shallow trays & 10 pairs of runners. Dimensions: height - 725mm, width - 710mm, depth - 420mm.  
**SER2025-KIT-1** **\$499.95**

~~\$724.95~~  
**\$539<sup>95</sup>**  
 Save \$185.00



**Gratnells Double Column Trolley - 725mm, F1 & F2**  
 This is a Gratnells double column trolley storage set in silver. It measures 725mm. This includes 1 trolley, 10 Shallow trays, 4 Deep trays & 6 pairs of runners. Dimensions: height - 725mm, width - 710mm, depth - 420mm.  
**SER2025-KIT-2** **\$539.95**

## Trolleys

**Gratnells Double Column Trolley - 850mm, F1**

This is a Gratnells double column trolley storage set in silver. It measures 850mm. This includes 1 trolley, 12 Shallow trays & 12 pairs of runners. Dimensions: height - 850mm, width - 710mm, depth - 420mm.

SER2025-KIT-3K

\$699.95

~~\$779.35~~**\$621<sup>95</sup>**

Save \$157.40

**Gratnell Double Column Trolley - 850mm, F1 & F2 & F3**

This is a Gratnells double column trolley storage set in silver. It measures 850mm. This includes 1 trolley, 2 Shallow trays, 2 Deep Trays, 2 Jumbo trays & 12 pairs of runners. Dimensions: height - 850mm, width - 710mm, depth - 420mm.

SER2025-KIT-4

\$621.95

~~\$829.15~~  
**\$629<sup>95</sup>**

Save \$199.20

**Gratnells Double Column Trolley - 850mm, F1 & F2**

This is a Gratnells double column trolley storage set in silver. It measures 850mm. This includes 1 trolley, 2 Shallow trays, 6 Deep Trays & 8 pairs of runners. Dimensions: height - 850mm, width - 710mm, depth - 420mm.

SER2025-KIT-5

\$629.95

**Double Width Trolley - 725mm**

A heavy duty storage frame for your classroom or laboratory. This frame can hold any of the 31 x 43cm Gratnells trays. Now you can transport all your equipment from the store to the classroom and back again with ease. Our shelved trolleys have been specially designed to store large or wide items. Heavy duty storage for education and laboratory. Made in the UK. Includes: metal top, 4x 75mm diameter castors (wheels). Dimensions: height: 850mm, width: 710mm, depth: 420mm.

SER2025-725-S

\$475.95

**Double Width Trolley - 850mm**

A heavy duty storage frame for your classroom or laboratory. This frame can hold any of the 31 x 43cm Gratnells trays. Now you can transport all your equipment from the store to the classroom and back again with ease. Our shelved trolleys have been specially designed to store large or wide items. Includes: metal top, 4x 75mm diameter castors (Wheels). Dimensions: height: 725mm, width: 710mm, depth: 420mm.

SER2025-850-S

\$599.95



Save  
**\$229<sup>65</sup>**



**Gratnells - Callero Storage Unit**

Includes Storage Unit, Runners and 6 x Jumbo Trays. Kit is available with clear, coloured or transparent trays. Contents may vary.

GT3044-6C 6 Jumbo Trays - Clear \$749.95  
GT3044-6S 6 Jumbo Trays - Solid \$749.95

Save  
**\$249<sup>30</sup>**



**Gratnells - Callero Storage Unit**

Includes Storage Unit, Runners and 12 x Deep Trays. Kit is available with clear, coloured or transparent trays. Contents may vary.

GT3044-12C 12 Deep Trays - Clear \$849.95  
GT3044-12S 12 Deep Trays - Solid \$849.95

Save  
**\$318<sup>00</sup>**



**Gratnells - Callero Storage Unit**

Includes Storage Unit, Runners and 16 x Shallow and 4 x Deep Trays. Kit is available with clear trays or coloured, transparent trays. Contents may vary.

GT3044-16C 16 Shallow & 4 Deep Trays - Clear \$899.95  
GT3044-16S 16 Shallow & 4 Deep Trays - Solid \$899.95

Save  
**\$54<sup>55</sup>**



**Gratnells - Callero Tilted Storage**

Includes Storage Unit, Runners and 9 x Deep Trays. Kit is available with clear, coloured or transparent trays. Contents may vary.

GT3244-C 9 Deep Trays - Clear \$729.95  
GT3244-S 9 Deep Trays - Solid \$729.95



**Gratnells Gratstack**

Gratnells Gratstack 2x Shallow & 2x Deep Trays

SERGS602 2 x Shallow & 2 x Deep Trays \$149.95



**Gratnells GratStack - 3x Deep Trays**

GratStack single column set including 3 Deep trays.

SERGS642 3x Deep Trays \$149.95

## Storage Units

### ERGERITE Ergerite Storage System

Versatile storage units, perfect for creating flexible learning spaces. These exclusive storage systems can be used with our storage tube, or also with the LEGO® Education Storage tubs. Each unit comes with castors for easy mobility and each measures 78cm high. The kits include plastic storage containers (SUN831L and SUN832S). All units are also compatible with Grattells containers.

#### Ergerite – Storage System Single

38cm (W)  
47cm (D)  
78cm (H)

- SUN831 Storage Unit only **\$159.95**
- SUN831K Storage Unit + 2 large trays + 3 small trays **\$209.95**

#### Ergerite – Storage System Double

72cm (W)  
47cm (D)  
78cm (H)

- SUN832 Storage Unit only **\$239.95**
- SUN832K Storage Unit + 4 large trays + 6 small trays **\$339.95**

#### Ergerite – Storage System Triple

106cm (W)  
47cm (D)  
78cm (H)

- SUN833 Storage Unit only **\$319.95**
- SUN833K Storage Unit + 6 large trays + 9 small trays **\$459.95**



Triple Storage Save **\$425**

DM11017K **\$599.95**  
Save **\$33.25**



DM11016K  
69cm (L)  
45cm (W)  
66cm (H)  
DM11017K  
102cm (L)  
45cm (W)  
66cm (H)



#### Natural Spaces – Storage & Trays

These flexible storage units are available with and without plastic containers. Double measures 69(W) x 45(D) x 66(H)cm and Triple measures 102(W) x 45(D) x 66(H)cm. All units include castors. The kits include wooden shelving plus plastic storage containers (SUN831L and SUN832S). Also compatible with Grattells containers. Contents may vary.

- DM11017K Triple Width Storage & Trays **\$599.95**
- DM11016K Double Width Storage & Trays **\$379.95**

#### Grattells Tall Chemical Storage Double Frame Kit

This is a Grattells chemical storage frame kit that measures 1850mm. This includes 1 double column frame in silver, 12 Shallow trays, 4 Deep trays, 3 Jumbo trays, 8 shelves & 14 runners. Dimensions: height - 1850mm, width - 710mm, depth - 420mm.

SER2625-CHEM-K **\$1,199.95**



#### Grattells Tall Chemical Storage Triple Frame Kit

This is a Grattells chemical storage frame kit that measures 1850mm. This includes 1 triple column frame in silver, 6 Deep trays, 3 Jumbo trays, 12 shelves & 21 runners. Dimensions: height - 1850mm, width - 1055mm, depth - 420mm.

SER2625-CHEM **\$1,409.95**



\$1,792.85  
**\$1,409.95**  
Save **\$382.90**

## 0-9

3DuxDesign Kits 151

## A

Air Core 9, 128  
 Alcohol Burner 201  
 Alligator Clips 128  
 Ammeters 10, 129, 145  
 Analytical Balances 227  
 Anemometer 61, 141  
 Animals, Insects & Birds 1-2, 19-21  
 Aquaponics 23  
 Arduino Kits 158  
 Autoclave Bag 221

## B

Balances 6, 223-230  
 Banana Leads 133  
 Barometer 61  
 Batteries 215  
 Beakers 175-176, 189  
 Bean Bags 220  
 Bell Jars 176  
 Bench Mats 219  
 Binocular Microscopes 33-35, 241-242  
 Biology 11-54  
 Biology Books 53  
 Biology Charts 54  
 Biology Kits 53, 174  
 Biology Tools 30-32  
 Borosilicate Tubing 188, 214  
 Boson Kits 124-125, 155-156  
 Boss Head 203  
 Bottle Storage 207-208  
 Brushes 218  
 Bug Viewers 206  
 Bunsen Burner 200-201  
 Burettas 185  
 Burette Storage 208  
 Burettes 178, 191  
 Buzzer 129

## C

Calculators 199  
 Calorimeters 217  
 Cell Holders 128  
 Centrifuges 243  
 Charcoal Blocks 216  
 Chemicals 79-98  
 Chemistry 71-98  
 Chemistry Books 78  
 Chemistry Kits 77-78, 174

Chromatography Paper 217  
 Circuit Scribe 159  
 Clamps 203  
 Clinometer 146  
 Colorimeter 142  
 Colour Mixing 107-110  
 Combustion Boat 220  
 Compass 66  
 Compost Container 57  
 Conductivity Meter 141  
 Coplin Jar 179  
 Cork Borers 216  
 Cork Stoppers 213  
 Crocodile Clips 128  
 Crooke's Tube 136  
 Crucibles 219  
 Crystallising Dish 179  
 Current Balance Kit 128  
 Curriculum Kits 173-174

## D

Data Logger Sensors 164-172  
 Data Loggers 163, 172  
 Density Cubes 100  
 Desiccator 179, 194  
 Digital Balances 227-228  
 Digital Microscopes 35, 238-242  
 Dropping Bottles 179  
 Dry Block Heaters 230-232  
 Drying Racks 208, 210  
 Dynamic Trolley 101

## E

Earth, Space & Environment 55-70  
 Earth & Space Kits 67-68, 174  
 Electric Bell 112  
 Electricity Kits 10, 122-123  
 Electrodes 136  
 Electroflash 128  
 Electromagnet Kits 121  
 Electromagnets 121  
 Electrostatics 135  
 Environment Books 68-70  
 Evaporating Basins 211  
 Evaporating Dish 179  
 Explorer Balances 227  
 Eyedroppers 216

## F

Filter Paper 211  
 First Aid Kit 251  
 Fixed Resistor 131  
 Flasks 180-182, 193

Forces & Motions Sets 99  
 Fossils 59  
 Freezers 237  
 Fruit Clock 130  
 Funnels 183, 191, 218

## G

Galvanic Cell 130  
 Gauze Mats 202  
 Gears 104  
 Geology 3, 58  
 Glass Beads 176  
 Glass Cutters 216  
 Glassware 175-188  
 Glove Dispenser 208  
 Gloves 249  
 Glue Guns 221  
 Glue Sticks 221  
 Graduated Cylinders 185  
 Graph Pads 220  
 Gratnells Storage 253-268  
 Gravity 101  
 Grove 153-154

## H

Hall's Car 100  
 Hand Crank 5, 129  
 Handheld Microscopes 242  
 Hazard Labels 252  
 Heating Mantles 233  
 Hot Plate Stirrers 234  
 Hot Plates 233-234  
 Human Anatomy 1, 11-18  
 Hydraulics 102, 129  
 Hydrometers 237  
 Hygrometer 60, 142

## I

Inclinometer 146  
 Incubators 236  
 Induced Current 130  
 Iron Filings 118-119

## J

Jerrycans 250  
 Junior Microscopes 33-34, 239-241  
 Kitchen Scales 228-229

## L

Lab Coats 248  
 Lab Equipment 223-246  
 Lab Essential Kits 222  
 Labware 195-222

Lamp Holders	132
Lamps	133
Lead Storage	209
LED Lights	132
LED Ray Box	107
Lenses	113
Light	107-111
Light Boxes	111
Light Bulbs	132
Light Meters	141
Light Sources	109
littleBits Kits	126-127
<b>M</b>	
Magnet Kits	115-117
Magnetic Field	116, 119
Magnetic Stirrers	235
Magnetic Wands	115-116, 119-120
Magnets	115-120
Magnifiers	31, 204-206
Makerspace	147-162
Makerspace Trolleys	160
Makey Makey Kits	125-126, 157
Maps	65-66
Materials	71
Measuring Containers	217
Measuring Cylinders	184
Measuring Jugs	192
Measuring Scales	229-230
Meker-Fisher Burner	201
Mesh Sieves	220
Meters & Testing	141-146
Microscope Slides	36-52
Microscopes	33-35, 238-242
Millikan's Apparatus	130
Minerals	59, 70
Mini Beasts & Plastomounts	20, 24-29
Mirrors	113
Molecular Models	18, 72-76
Monocular Microscopes	33-34, 239-241
Mortar & Pestles	185, 218
Motors	7, 133
Multimeters	144-145
<b>N</b>	
Nebula Plasma Globe	136
New for 2020	1
Nichrome Wire	131
<b>O</b>	
Optical Bench Kits	107-108
Oscilloscopes	217
Ovens	236
<b>P</b>	
Pen Meters	5, 143
Periodic Table	78
Petri Dishes	185, 194
Physics	99-140
Physics Books	140
Physics Kits	137-139, 174
Pipette Fillers	207
Pipette Pumps	207
Pipette Storage	207
Pipettes	186, 191
Planck's Constant	136
Plants	2-3, 22-23
Plastic Syringes	193
Plasticware	189-194
Polypropylene Cylinders	192
Power Supply	131
Precision Balances	226-227
Prisms	109
Projectile Launcher	101
Pulleys	105
<b>Q</b>	
Quadrat Grids	217
<b>R</b>	
Ramps	100
Reagent Bottles	177, 190
Recycling and Sustainability	55-57
Recycling Bins	55
Refraction & Reflection	107-111, 113
Refrigerators	237
Renewable Energy	114
Resistance Coils	131
Retort Ring	204
Retort Stands	203-204
Rheostat	132
Rocks	59, 70
Rubber Ribbed Teats	220
Rubber Stoppers	213
Rulers	220
<b>S</b>	
Safety	246-252
Safety Charts	251
Safety Glasses	247-248, 255
Safety Screen	221, 251
Scout Balances	223-225
Senior Microscopes	34, 240-241
Sharps Containers	250
Simple Machines	102-104
Slopes	100
Soil & Water Testing	62-63, 142
Solar System	64
Space Books	68
Spatula	211
Speciment Tubes	194
Spectrometer	112
Spectroscope	112
Spotting Plates	212
Springs	101, 112, 217
Standards	185
Steel Chips	119
STEM/STEAM	99, 104, 117, 147-162
Stirrers	212
Stopwatches	195
Storage	160, 253-268
Storage Frames	256-260
Storage Racks	209
Storage Trays	210, 253
Storage Trolleys	260-268
Switches	134
<b>T</b>	
Tape Measure	212
TeacherGeek Kits	147-150
Tesla Coil	220
Test Strips	146
Test Tube Storage	209-210
Test Tubes	187-188, 194
The Cool Tool Kits	152
Thermometer Storage	207
Thermometers	196-198
Tongs	219
Torches	110
Traveller Balances	227
Tray Inserts	254-255
Tripods	202
Troughs	194
Tweezers	216
<b>U</b>	
UV Reacting Paper	217
Vacuum Pump	8, 243
Van De Graaff Generator	135
Voltmeters	10, 129, 144
<b>W</b>	
Wash Bottles	190
Water Baths	243-246
Weather	60-61
Weighing Trays	193
Weights	106
Wire	134
World Globes	65







---

## Trusted Specialist Science Education Brands



Based in the county of Bedfordshire in the United Kingdom, Data Harvest has been producing high quality educational science data logging products since 1985 and was the first company to bring data capture technology to the mainstream UK classroom.

---



IEC is known in Australia and around the world as a designer and manufacturer of a large range of educational equipment for the teaching of science, physics and chemistry. Using their heritage as scientific engineers, the quality and performance of IEC equipment is their first priority. IEC is proud to have 100% Australian heritage and ownership.

---



Established in Newark, New Jersey, in 1907 as a small scale repair business, Ohaus has become a trusted supplier of precise and reliable balances and scales.

---



Eisco Scientific started over 50 years ago as a small, family-owned manufacturing company serving the science education marketplace and now produces over 6,500 unique science education products from physics, chemistry and lab supplies to glassware.

---



## Lab Essentials Class Kit

This Lab Essentials Class Kit is an ideal laboratory equipment essentials set. It includes a great range of high quality scientific resources to help start and equip your lab or replenish your existing science materials inventory. This great value set provides massive savings on a broad range of high quality science resources and includes the following lab glassware and equipment.

- 12 x Beaker - Borosilicate Glass 100ml - Glass
- 12 x Beaker - Borosilicate Glass 250ml - Glass
- 12 x Cylinders Graduated 100ml - Glass
- 12 x Cylinders Graduated 250ml - Glass
- 12 x Boiling Flask 250ml - Glass
- 6 x Boiling Flask 500ml - Glass
- 12 x Erlenmeyer Flask 100ml - Glass
- 2 x Erlenmeyer Flask 250ml - Glass
- 100 x Test Tubes 15cm x 1.6cm dia

- 5 x Test Tube Stand - Polypropylene
- 5 x Test Tube Brush
- 5 x Flask Brush
- 5 x Wash Bottles 250ml - Polyethylene
- 8 x Bunsen Burner with Flame Stabilizer
- 8 x Rubber Tubing for Bunsen Burner - 600mm
- 8 x Wire Gauze
- 8 x Tripod Stand Triangular - 21cm high
- 8 x Retort Stand & Rod
- 30 x Thermometer
- 8 x Thermometer Clamp
- 8 x Closed Ring with Clamp
- 8 x Boss Head

SCI002

~~\$1,778.75~~  
**\$1,499<sup>95</sup>**  
—  
Save **\$278.80**



Kit **\$1,499.95**



**Flexible freight  
options available**

Prices exclude taxes & duties

teaching.com.au  
P +61 2 9907 5260 E export@teaching.com.au

MTEXSCI20

7138