

Ravensburger **3D**
puzzle®

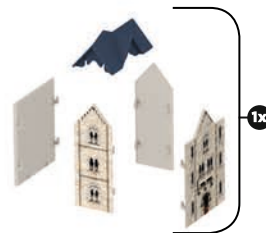

Schloss Neuschwanstein • Füssen

Ravensburger

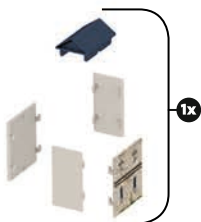
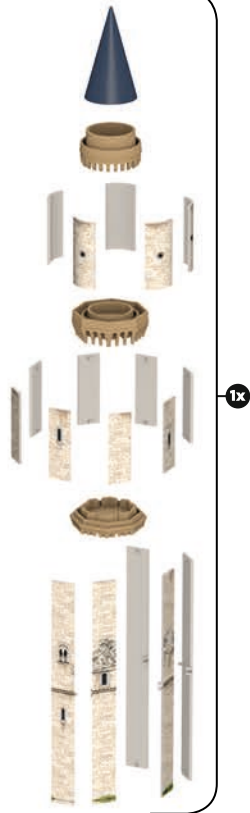
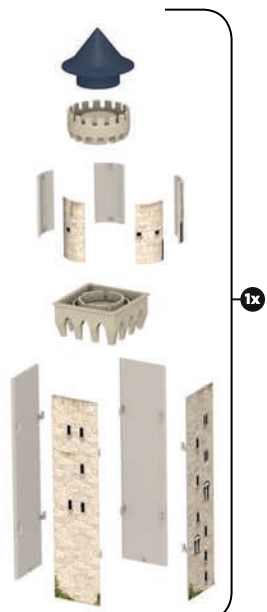
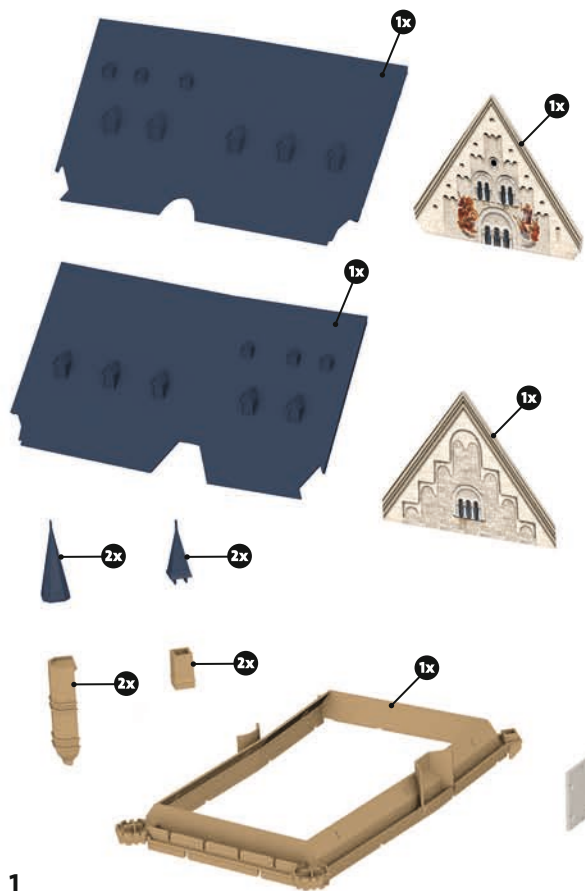

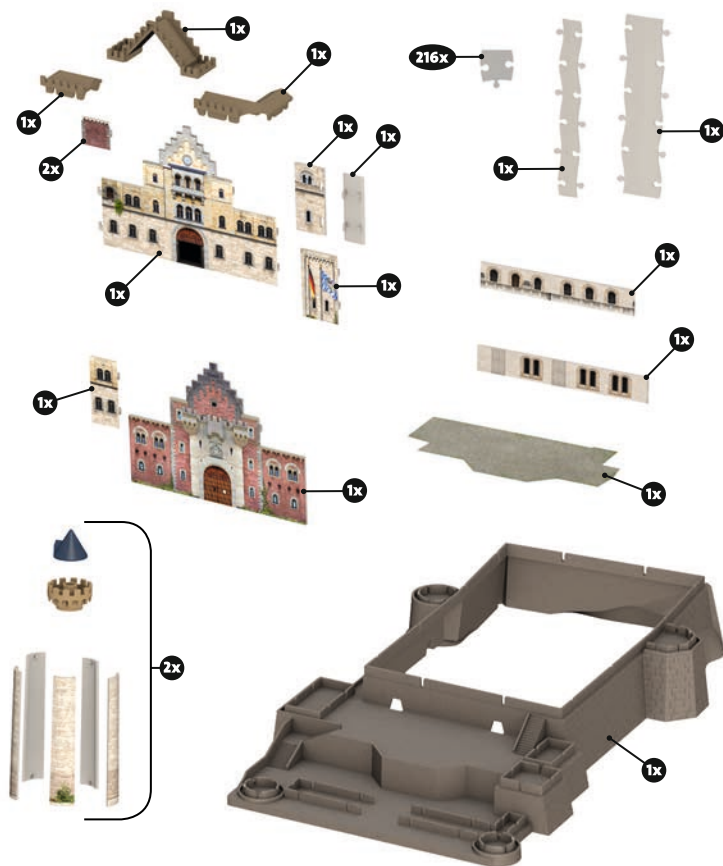

Knick-Puzzleteile vorknicken
 Pre-bend hinged puzzle pieces
 Pré-plier les pièces de puzzles avec un pli
 Piegare le tessere del puzzle con scanalatura
 Doblar las piezas de puzzle plegables
 Puzzelstukjes met een knik voorbuigen



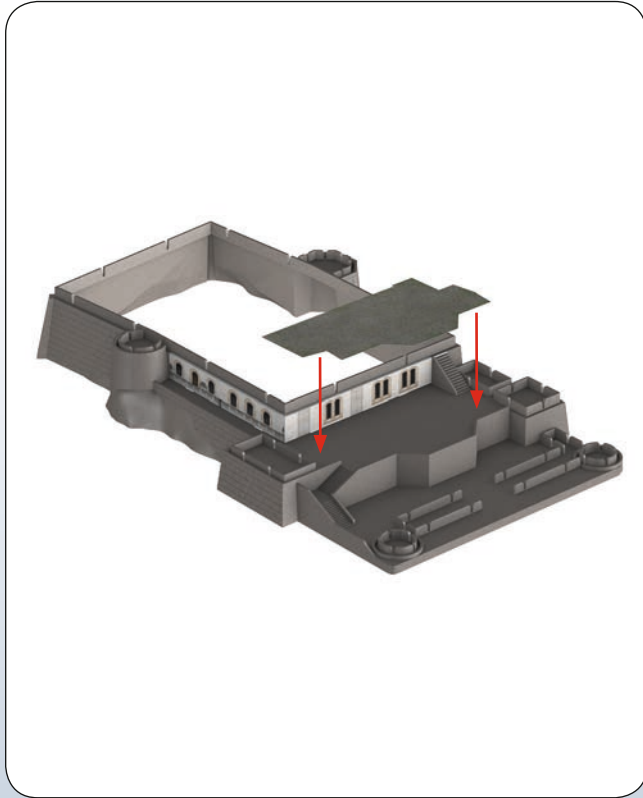
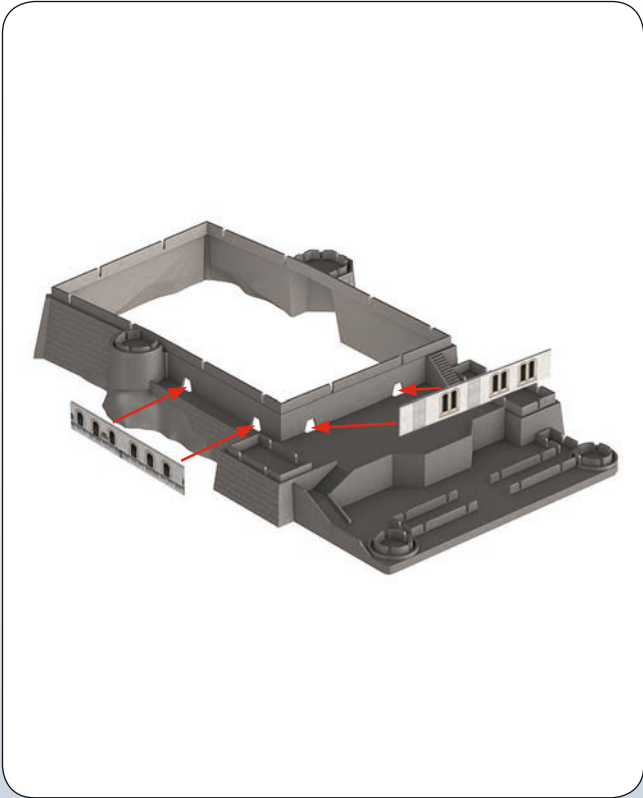

 1-120

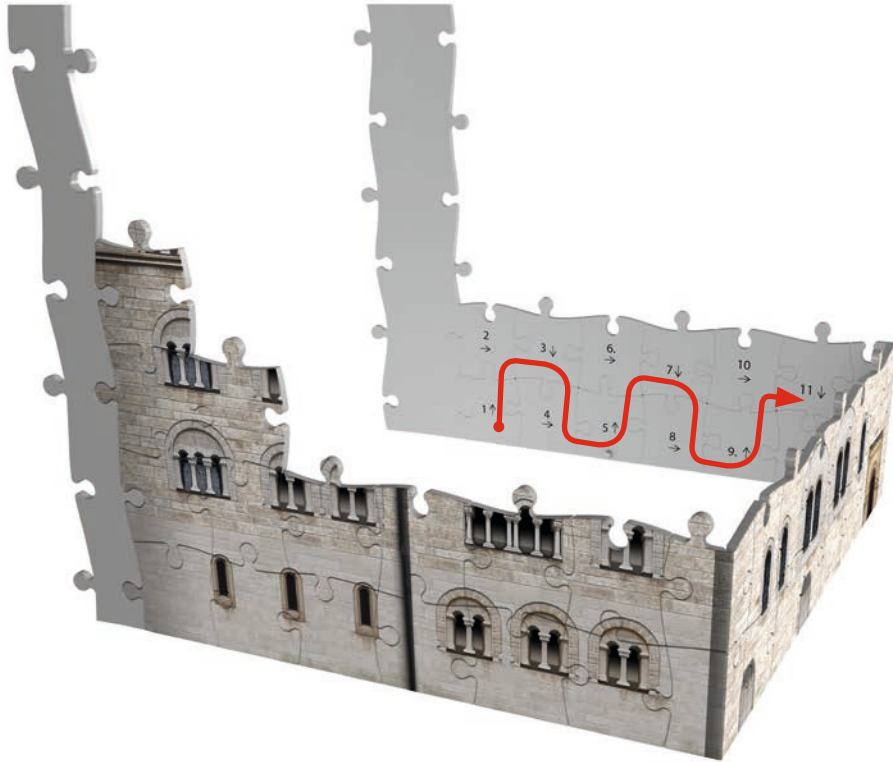

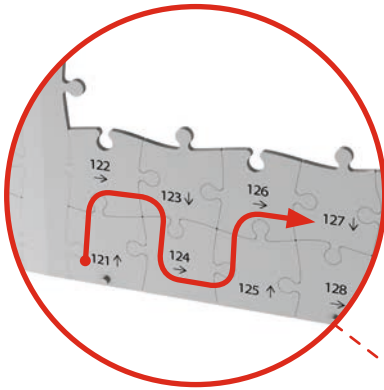

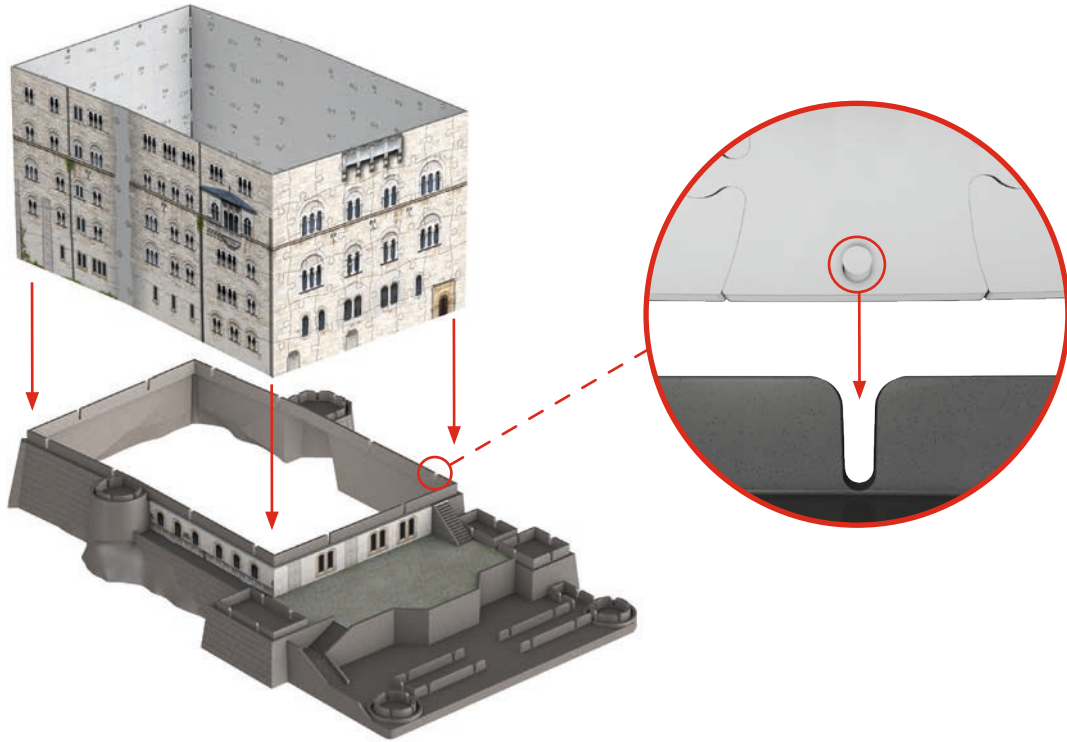

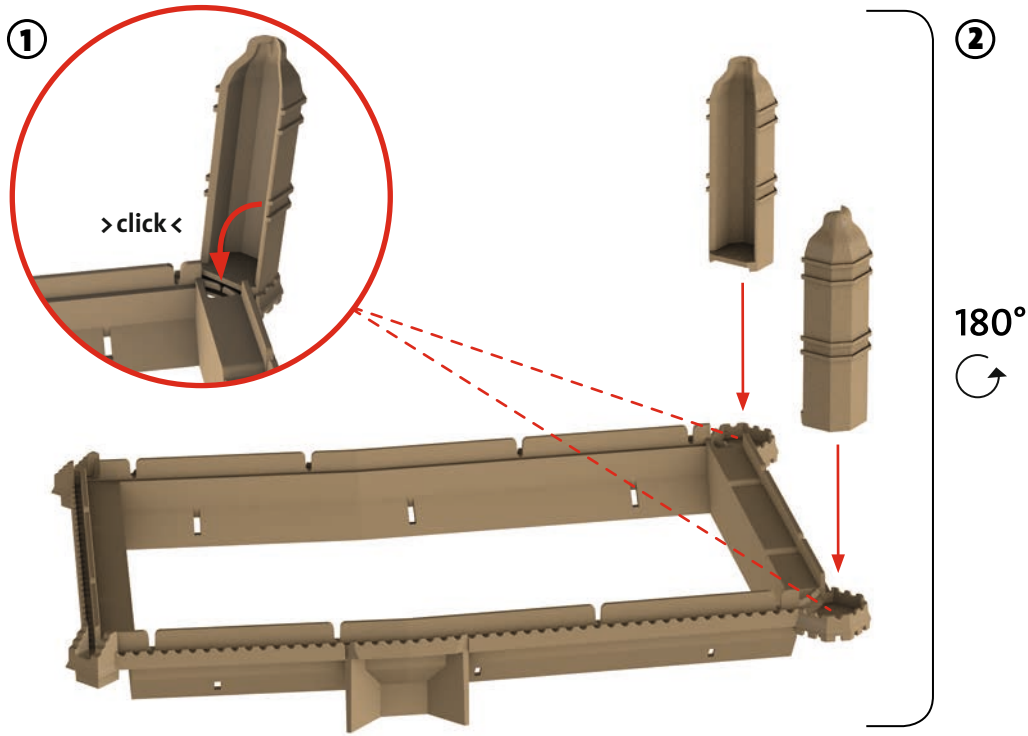

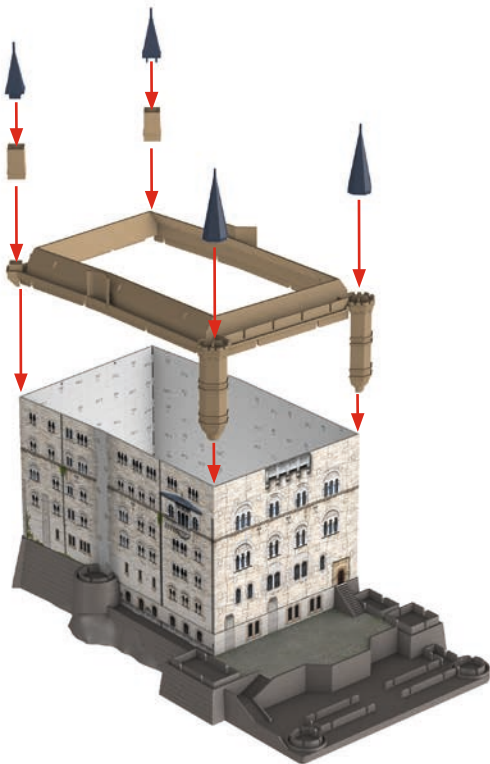

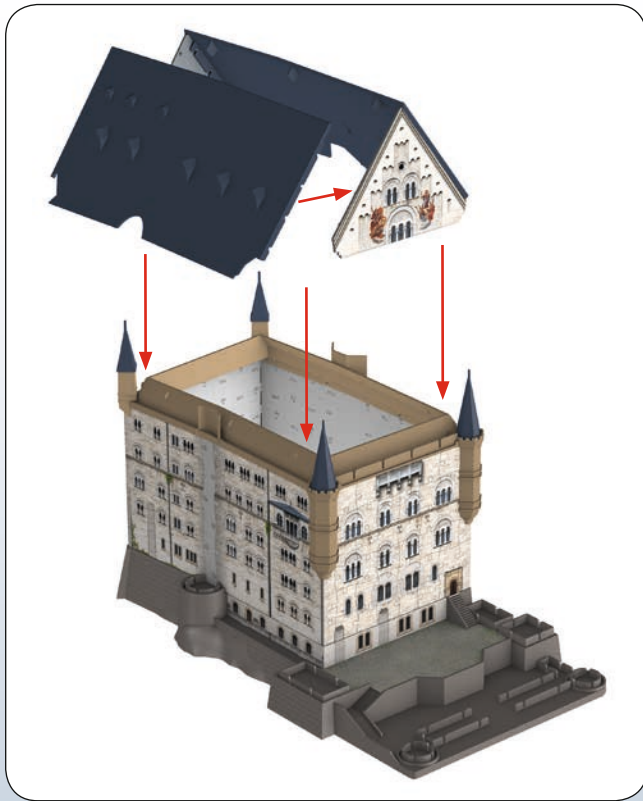
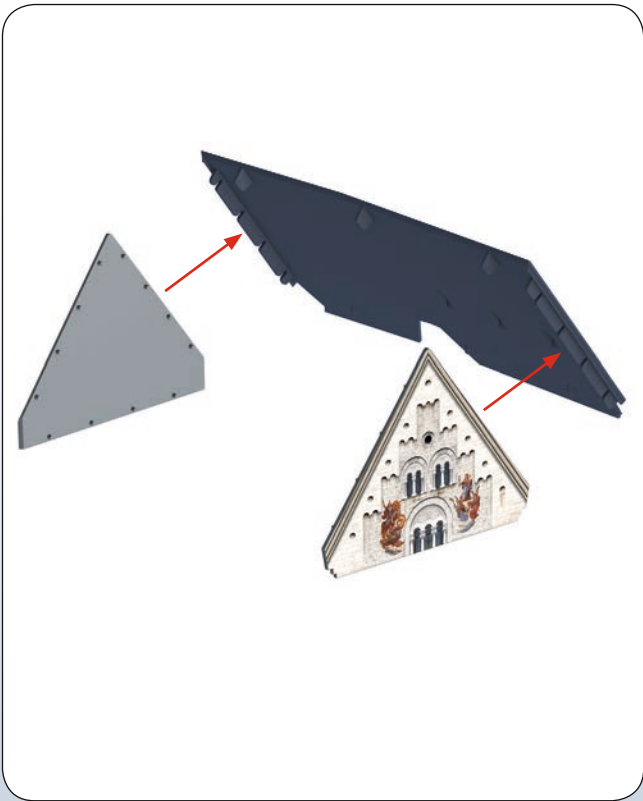

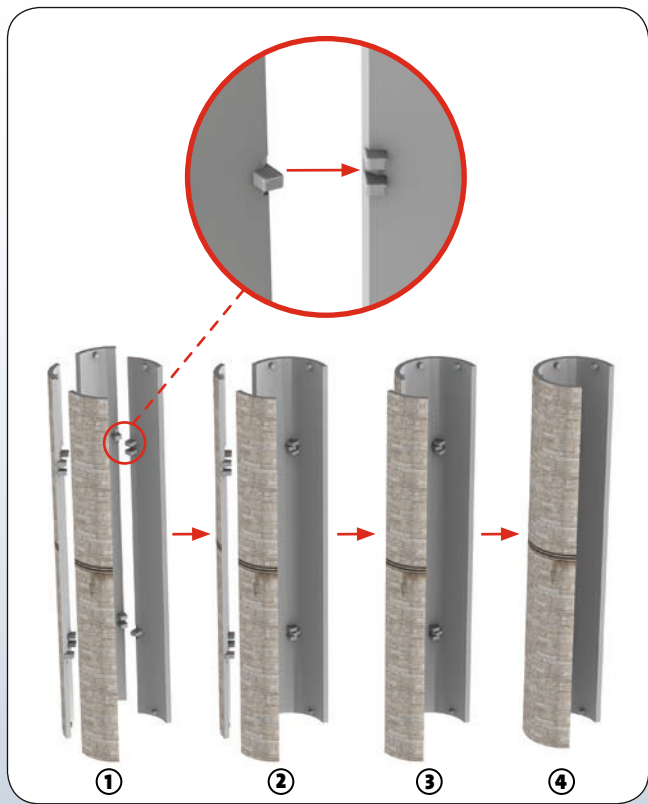

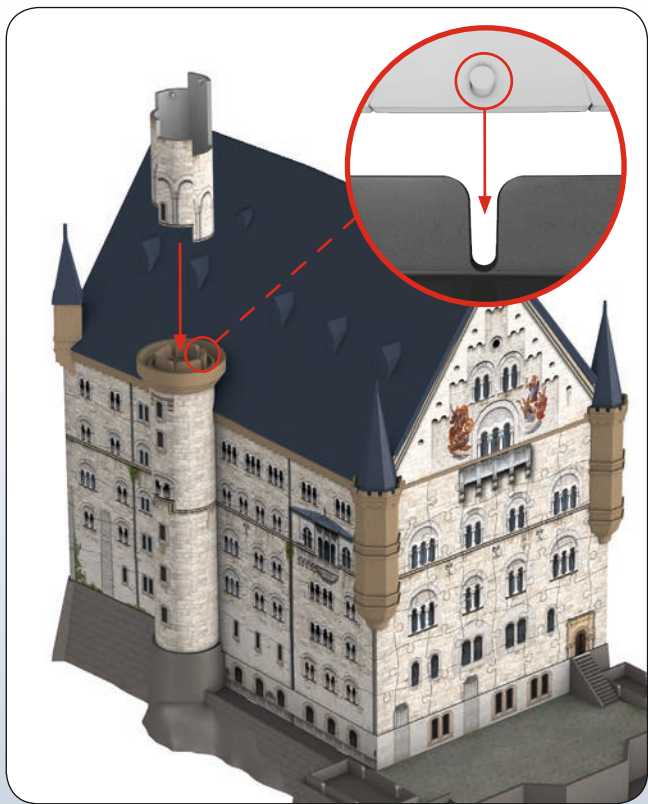

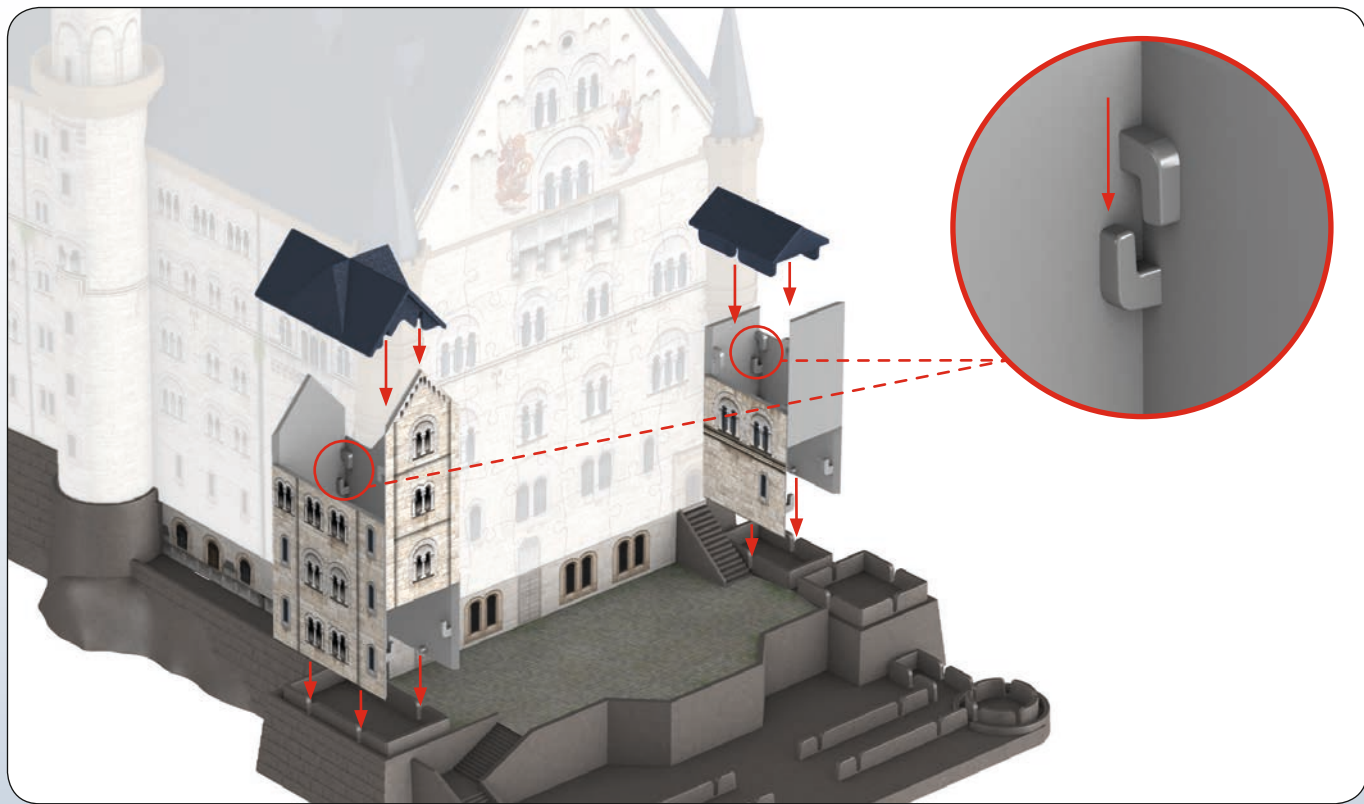

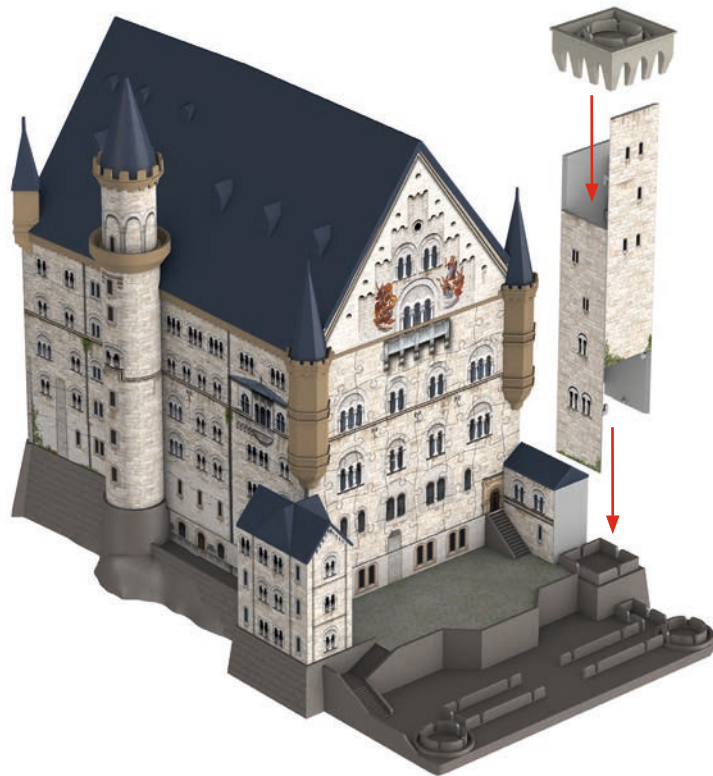

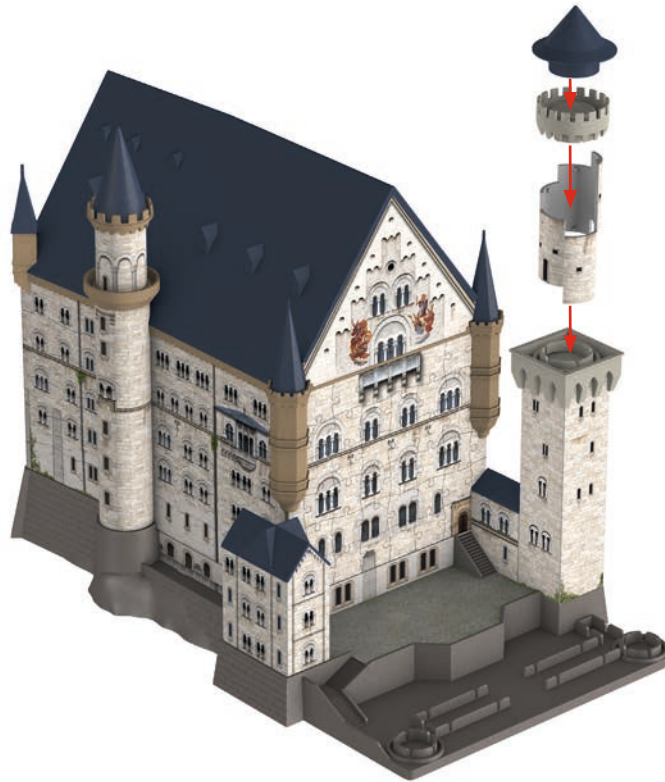

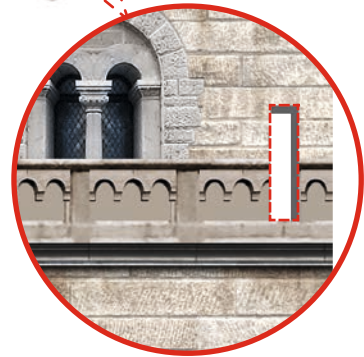
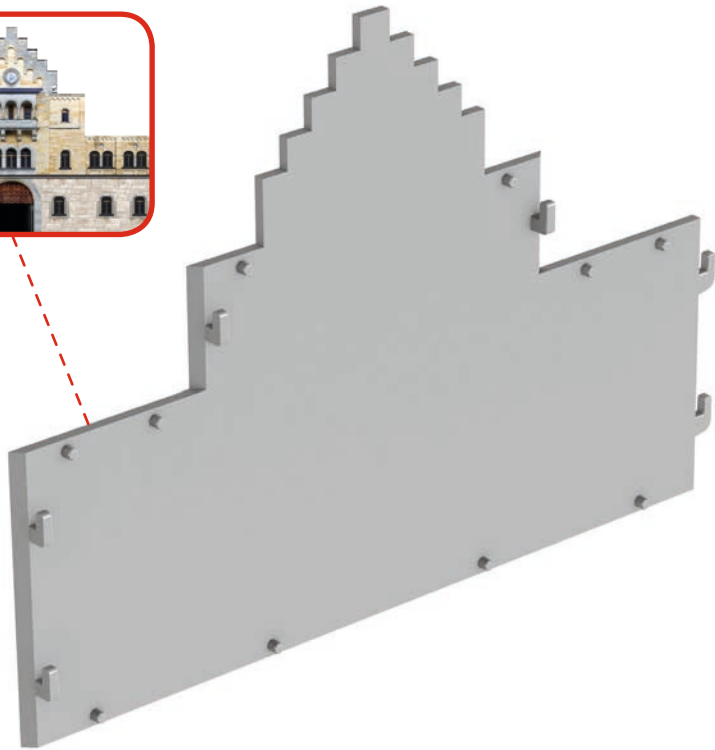

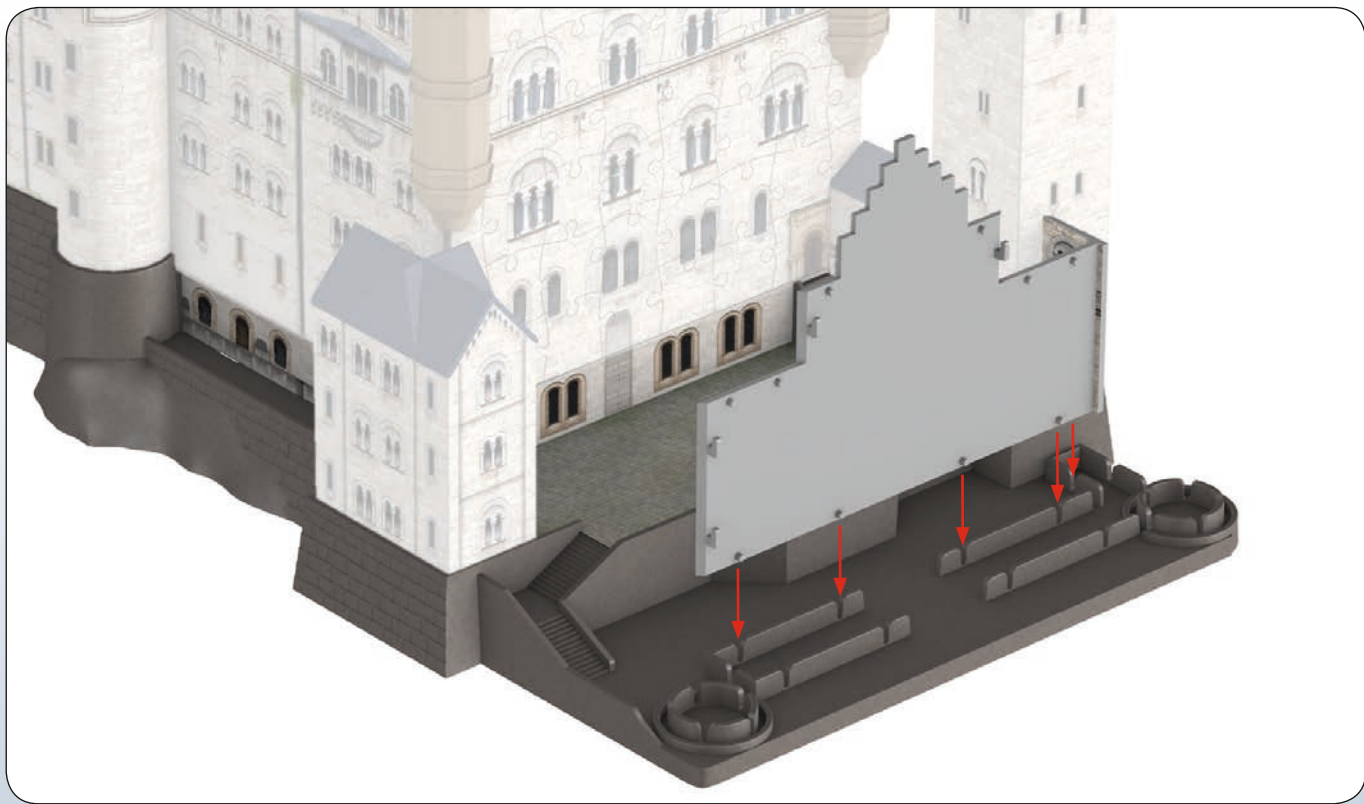

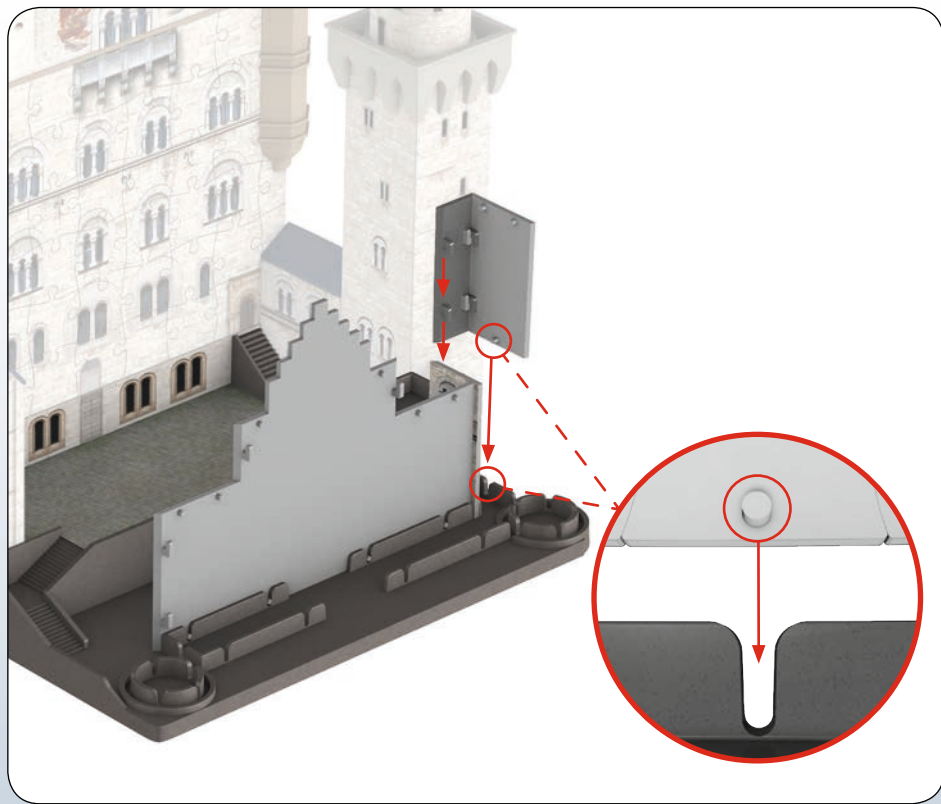
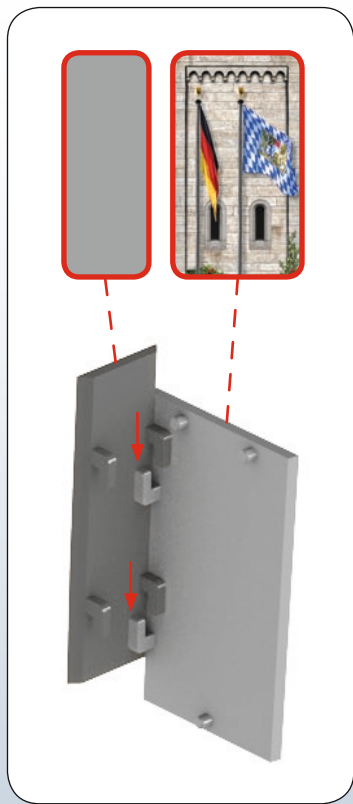

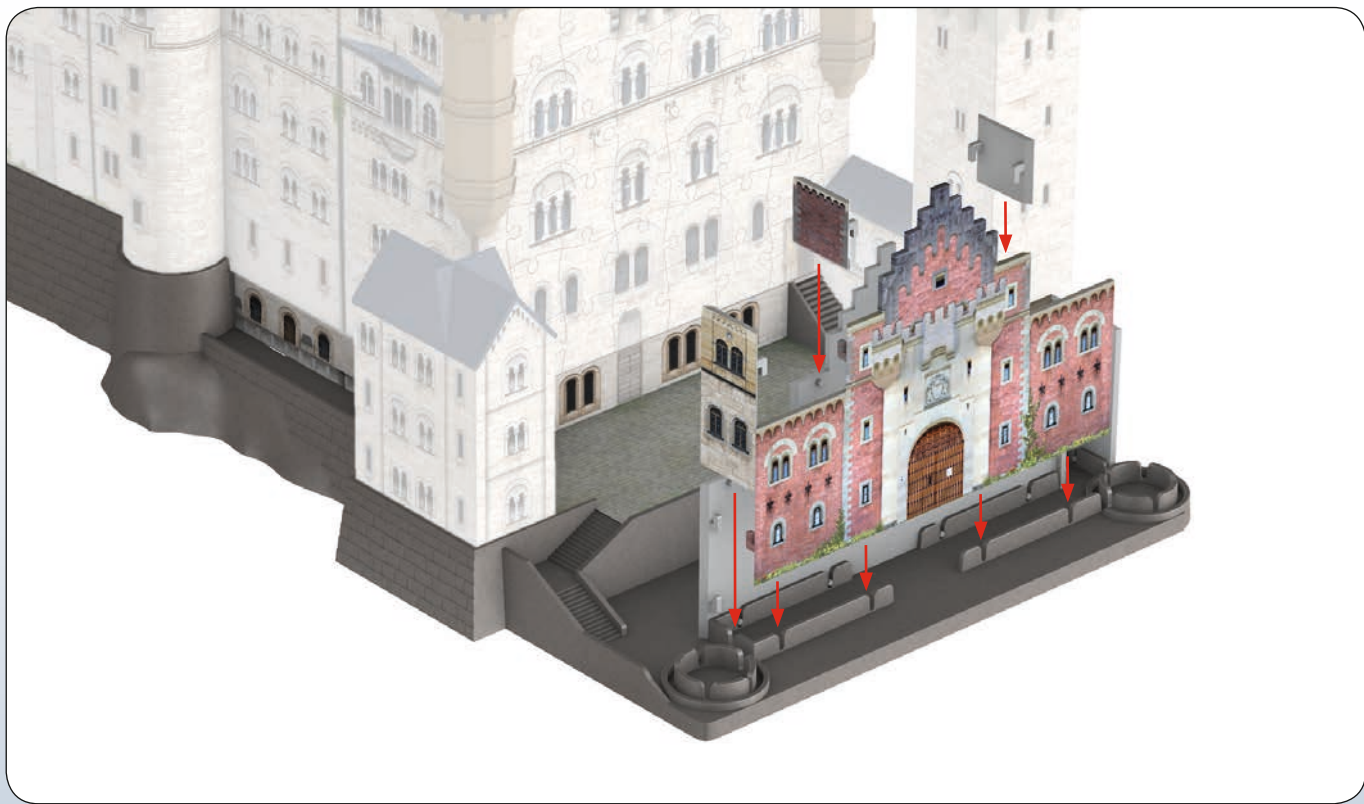

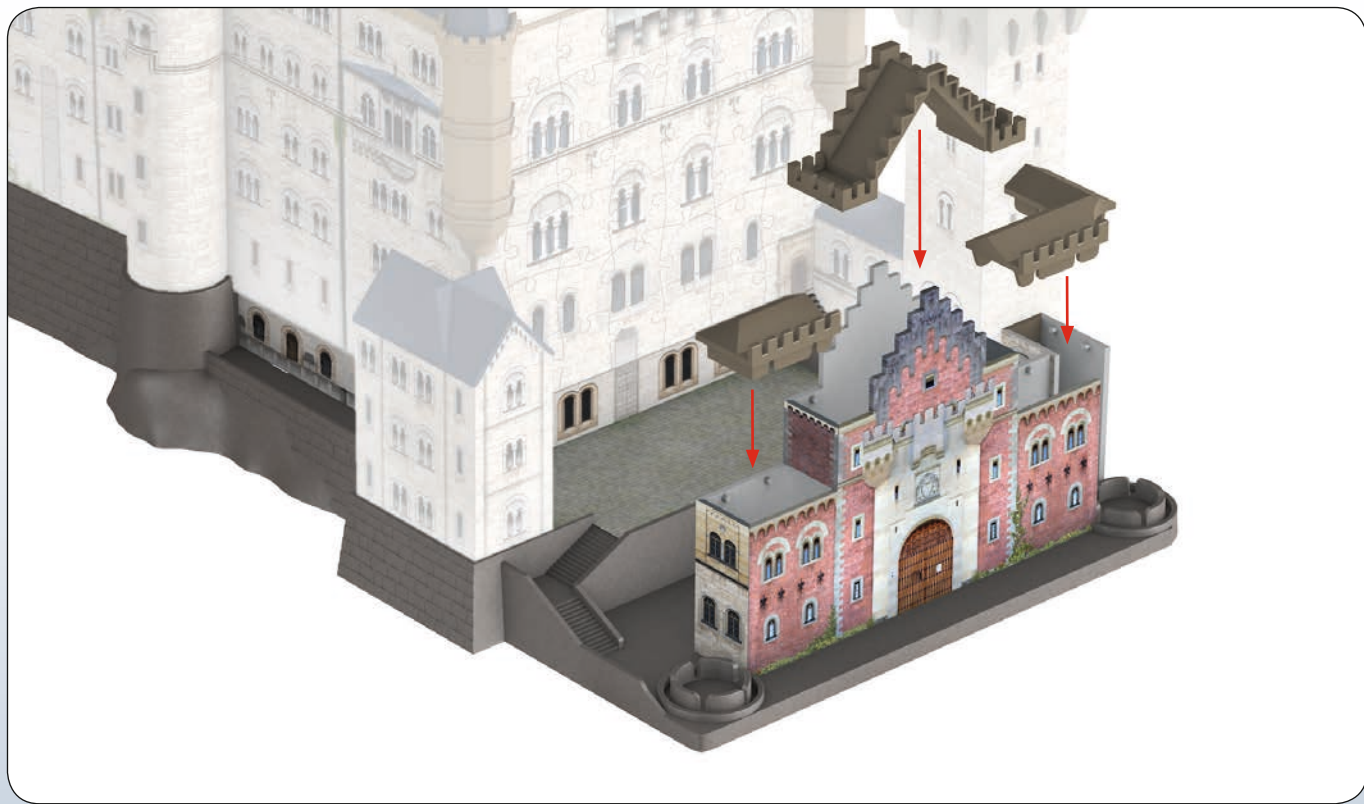

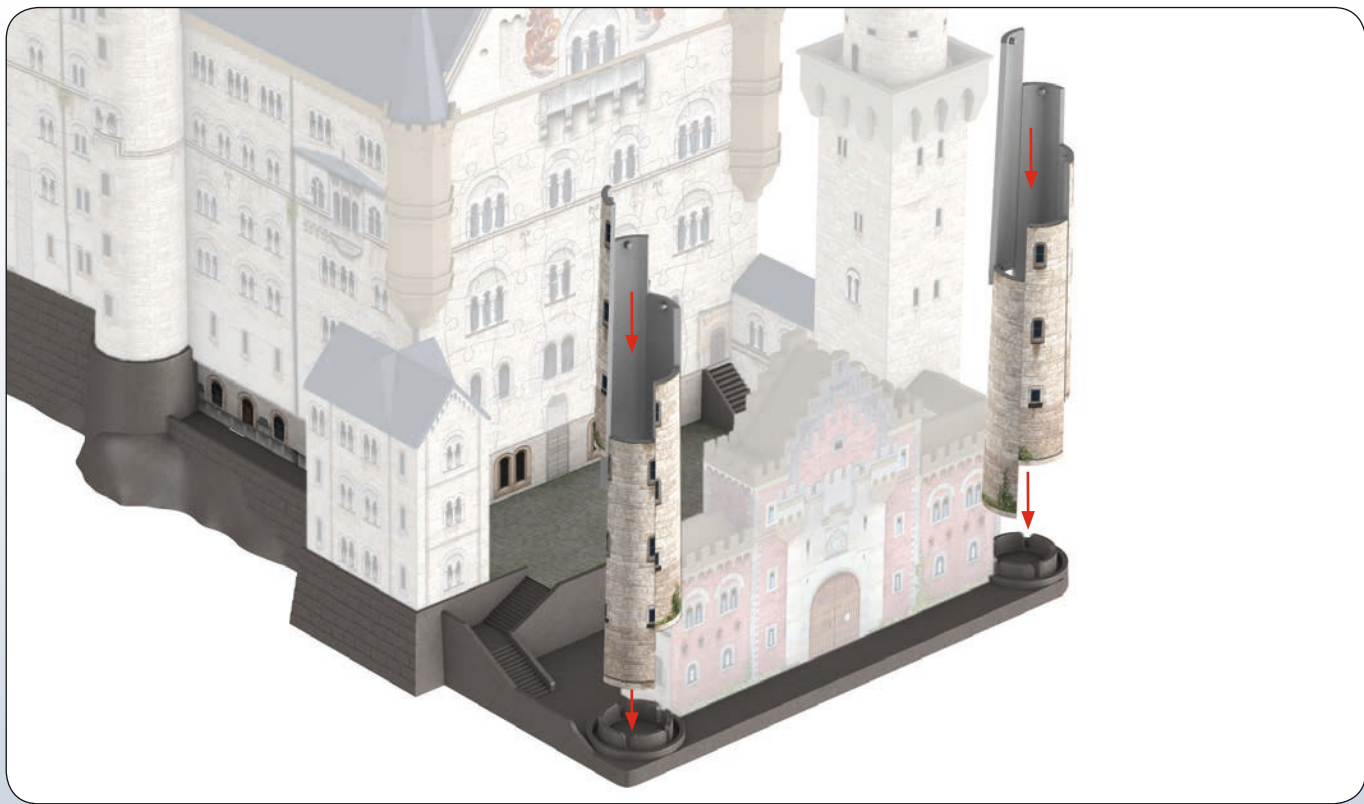

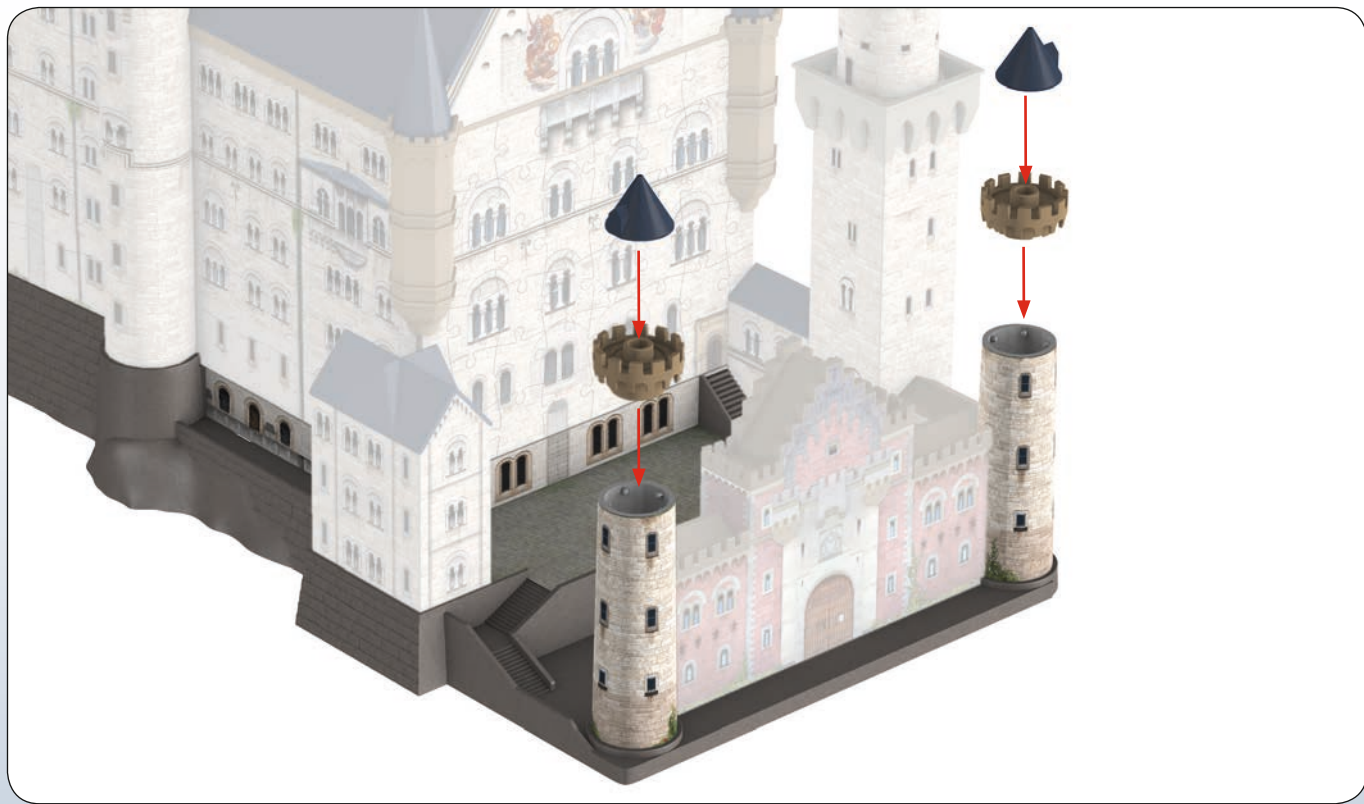

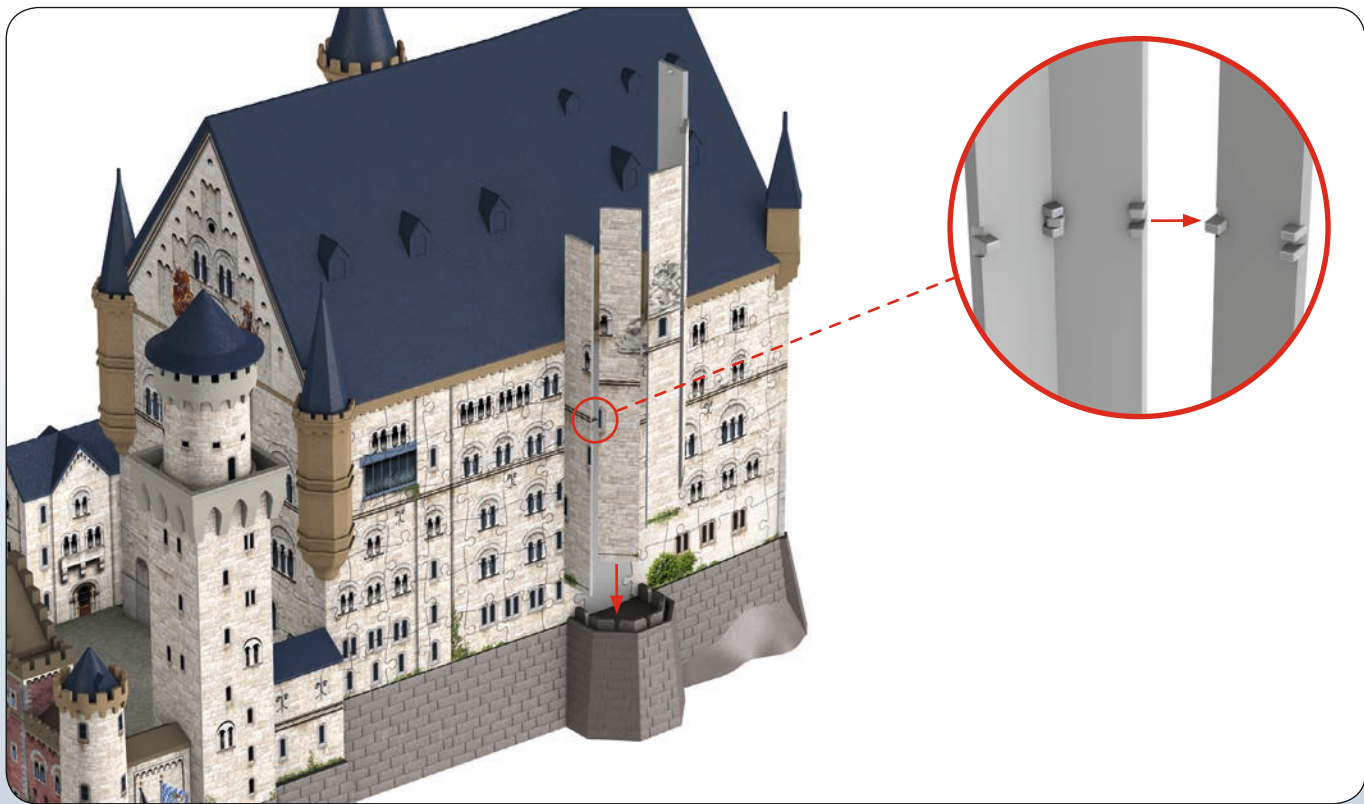



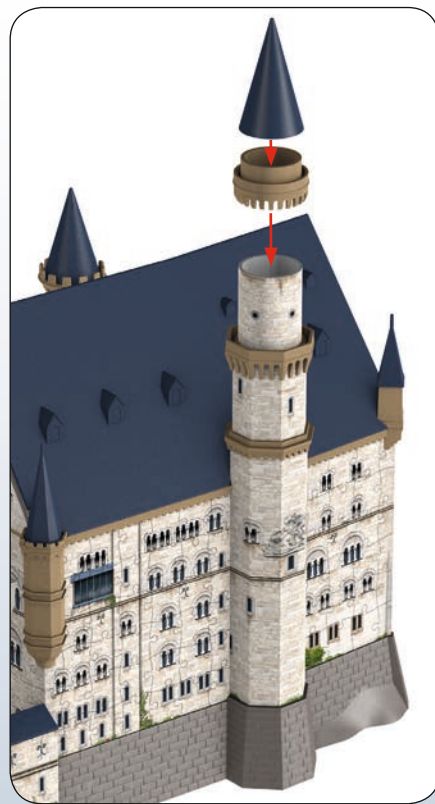
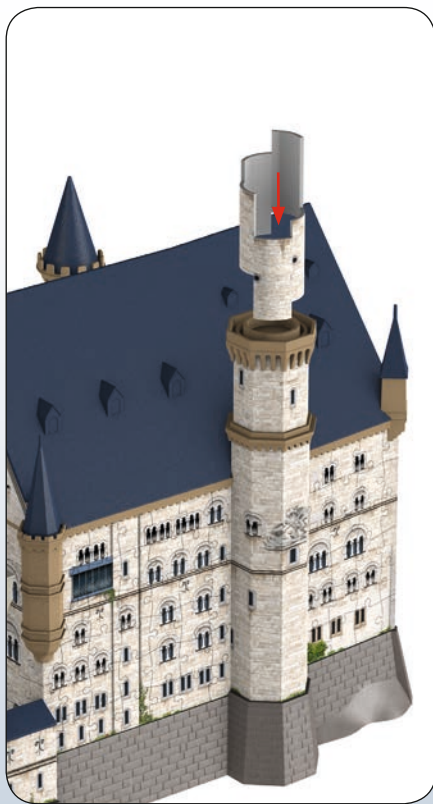
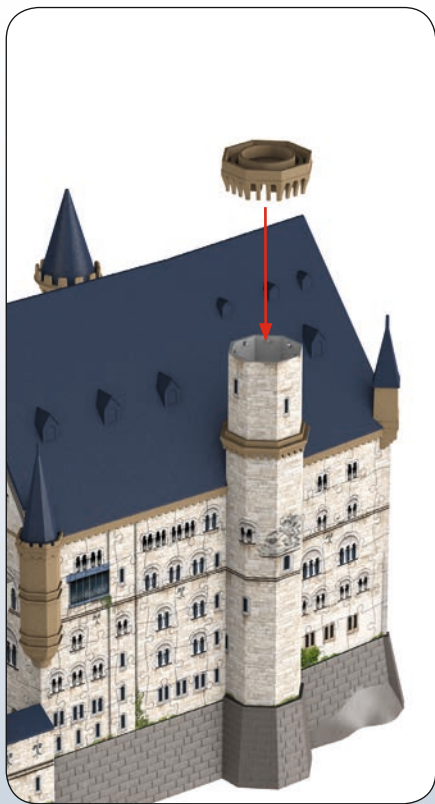

D 

Schloss Neuschwanstein

Nicht zuletzt wegen der verspielten Architektur, den liebevoll ausgearbeiteten Details und dem bewussten Verzicht auf starre Symmetrie ist das Schloss Neuschwanstein eines der beliebtesten und bekanntesten Sehenswürdigkeiten Deutschlands und gilt als Sinnbild für die Zeit der Romantik.

Jährlich kommen mehr als 1 Mio. Touristen aus aller Welt nach Bayern, um sich das oberhalb der Stadt Füssen gelegene Schloss aus nächster Nähe anzuschauen. Das Ironische dabei ist, dass der Wille des etwas eigensinnigen Erbauers König Ludwig II. ein ganz anderer war: er wollte nämlich sein ganz persönliches Märchenschloss verwirklichen, das für andere Besucher niemals zugänglich sein sollte. Aber um das in finanzielle Notlage geratene Großprojekt doch noch umsetzen zu können, wurden die Tore für Besucher sogar bereits vor Fertigstellung geöffnet. So haben Besucher seit dem Jahr 1886, etwa 17 Jahre nach Baubeginn, Zutritt zum Schloss und können sich von der beeindruckenden Ausgestaltung der Innenräume, wie dem Thron- oder dem Sängersaal, verzaubern lassen.

Dem Zauber dieses Schlosses ist einst sogar Walt Disney erlegen, denn er hat die Schlösser in seinen Filmen, Themenparks und selbst in seinem Logo an die einzigartige Architektur des Schloss Neuschwanstein angelehnt. Wenn Sie also das nächste Mal einen Disney Film einlegen, dann stellen Sie doch ihr selbst gebautes 3D Puzzle Schloss Neuschwanstein einfach mal neben den Bildschirm und schauen ganz genau hin.

GB/USA  

Neuschwanstein Castle

The playful architecture, charming details and deliberate lack of rigid symmetry make Neuschwanstein Castle one of Germany's best-known and most popular sights, and widely considered the symbol of the Romantic era.

Every year, more than one million tourists from all over the world travel to Bavaria for a closer look at the castle that lies above the town of Füssen. The irony is that King Ludwig II, the rather stubborn individual who was responsible for its construction, actually wanted quite the opposite: he wanted to create his own, very personal fairytale castle, and it was never to be seen or entered by other visitors. But his plans eventually ran into financial trouble, and so the gates were actually opened to visitors even before the castle was completed in order for the project to continue. Visitors have been able to access the castle since 1886, around 17 years after construction commenced, and be enchanted by the impressive interior, such as the throne room and Singers' Hall.

Even Walt Disney himself succumbed to the castle's magic, and based the castles in his films, theme parks and even in his logo on the unique architecture of Neuschwanstein Castle. So next time you treat yourself to a Disney film, then why not put your 3D puzzle of Neuschwanstein Castle next to the screen and compare the two?

F 

Château de Neuschwanstein

Si le château de Neuschwanstein est l'un des sites les plus appréciés et les plus célèbres en Allemagne, et constitue le symbole de l'époque romantique, c'est sûrement à cause de son architecture recherchée, de l'amour du détail et de l'absence volontaire de toute symétrie rigide.

Plus d'un million de touristes venus du monde entier se rendent chaque année en Bavière pour admirer de plus près le château situé sur les hauteurs de la ville de Füssen. Quelle ironie quand on pense que la volonté de son bâtisseur, l'obstiné roi Louis II de Bavière était, au contraire, de réaliser un château de conte de fée pour son propre usage, inaccessible à toute personne étrangère ! Mais pour réaliser ce projet pharaonique, face à une situation financière critique, les portes furent ouvertes aux visiteurs avant même la fin des travaux. C'est ainsi que, depuis 1886, soit environ 17 ans après le début du chantier, les visiteurs ont accès au château et peuvent admirer les intérieurs impressionnants comme la salle du trône ou la salle des chanteurs.

La magie de ce château a même inspiré Walt Disney, qui a repris dans ces parcs d'attractions, et même dans son logo, l'architecture unique de Neuschwanstein. La prochaine fois que vous regarderez un film de Disney, placez tout simplement votre puzzle 3D du château de Neuschwanstein à côté de l'écran et observez-les attentivement.

I 

Castello di Neuschwanstein

Soprattutto per la sua architettura fantasiosa, i dettagli elaborati con cura e la studiata rinuncia alla rigida simmetria, il castello di Neuschwanstein non è solamente uno tra i monumenti più amati e celebri della Germania, ma è anche considerato il simbolo del Romanticismo.

Ogni anno, i turisti provenienti da tutto il mondo che si recano nei pressi della città di Füssen, in Baviera, per ammirare da vicino il castello, sono oltre 1 milione. In realtà, il capriccioso re Ludwig II lo fece costruire per uno scopo ben diverso: voleva un castello fiabesco esclusivamente suo, nessun'altra persona avrebbe mai potuto accedervi. Per ironia della sorte, le difficoltà finanziarie compromisero la realizzazione di questo imponente progetto. Le porte del castello vennero perciò aperte ai visitatori già prima dell'ultimazione dell'edificio. A partire dal 1886, circa 17 anni dopo l'inizio dei lavori, le persone ebbero così la possibilità di entrare nel castello per poter osservare incantati gli incredibili allestimenti degli spazi interni, come la Sala del trono e la Sala dei cantori.

Persino Walt Disney rimase affascinato dal castello di Neuschwanstein a tal punto da prenderne a modello la straordinaria architettura per i suoi film, i parchi tematici e addirittura per il suo Logo. La prossima volta che vi capiterà di guardare un film della Walt Disney, accostate allo schermo della televisione il puzzle 3D del castello di Neuschwanstein da voi realizzato e confrontatelo attentamente.

E 

Castillo de Neuschwanstein

Por su original arquitectura, sus esmerados detalles y el intencionado alejamiento de la simetría rígida, el Castillo de Neuschwanstein se ha convertido en uno de los lugares de interés más conocidos y apreciados de Alemania y es considerado un símbolo de la época del romanticismo.

Cada año, más de un millón de turistas de todo el mundo viajan hasta Baviera para contemplar en primera persona este palacio, situado por encima de la ciudad de Füssen. Lo irónico de este castillo es que la voluntad del caprichoso rey Luis II, quien lo mando construir, era otra muy distinta: quería tener un castillo de cuento de hadas para él solo al que ningún visitante tuviera acceso. Sin embargo, para poder hacer frente a los problemas financieros que surgieron al llevar a cabo este gran proyecto, tuvieron que abrir las puertas a los visitantes incluso antes de que estuviera terminado. De este modo, desde 1886, unos 17 años después del inicio de las obras, los visitantes pueden acceder al castillo y dejarse embrijar por la impresionante configuración de sus espacios interiores, como la Sala del Trono o la Sala de los Cantores.

Hasta Walt Disney cayó rendido ante el encanto de este palacio e imitó su extraordinaria arquitectura en los castillos de sus películas, sus parques temáticos e incluso su logo. Así que la próxima vez que veas una película Disney, pon tu puzle 3D del Castillo de Neuschwanstein junto a la pantalla una vez lo hayas completado y fijate bien en el parecido.

NL 

Slot Neuschwanstein

Niet in het minst vanwege de speelse architectuur, liefdevol uitgewerkte details en het opzettelijk vermijden van stijve symmetrie is het kasteel Neuschwanstein een van de meest populaire en bekende toeristische attracties van Duitsland en wordt beschouwd als een symbool van de romantiek.

Elk jaar komen meer dan 1 miljoen toeristen uit de hele wereld naar Beieren, om te kijken naar het kasteel vanaf een locatie boven de stad Füssen. De ironie is dat de eigenzinnige koning Ludwig II een heel andere intentie had met het kasteel: Hij wilde namelijk zijn eigen persoonlijke sprookjeskasteel, die nooit beschikbaar zou zijn voor bezoekers. Maar omdat het project in grote financiële nood kwam ging dit niet door. De poorten voor bezoekers werden in 1886, zelfs voorafgaand aan de voltooiing, al geopend. Laat u betoveren door de indrukwekkende vormgeving van het interieur, zoals de troon of het Singer's Hall.

Zelfs Walt Disney is bezweken voor de magie van dit kasteel. In de kastelen in de Disney films, pretparken en zelfs in het logo is de unieke architectuur van het kasteel Neuschwanstein verwerkt. Als je dus de volgende keer een Disney film gaat kijken, zet dan maar je zelfgebouwde 3D Puzzel Neuschwanstein kasteel naast het scherm om ze te vergelijken!

Night Edition





www.ravensburger.com





Ravensburger **3D** puzzle[®]



232079

© 2014

Stand: Juni 2014

Ravensburger Spielverlag

Postfach 2460 · D-88194 Ravensburg

www.ravensburger.com

Dies ist ein internationaler Prospekt. Es ist daher möglich, dass nicht alle Motive in Ihrem Land erhältlich sind.

Dit is een internationale folder. Het is dus mogelijk dat niet alle motieven in uw land verkrijgbaar zijn.

Ce dépliant est international. Il est donc probable que tous les motifs ne soient pas disponibles dans votre pays.

Questo è un catalogo internazionale: è quindi possibile che alcuni soggetti non siano disponibili nel vostro paese.

This is an international brochure. It is therefore possible that not all designs are available in your country.

Este es un catálogo internacional. Por eso es posible que algunas imágenes no estén a la venta en su país.